

U
408.8

Reference

.A1
FM 55-9

FM 55-9

Reference

DEPARTMENT OF THE ARMY FIELD MANUAL

SIS FM 55-1

**TRANSPORTATION SERVICES
AND THE
TRANSPORTATION BRIGADE
IN THE
FIELD ARMY**

**HEADQUARTERS, DEPARTMENT OF THE ARMY
JUNE 1965**



**TRANSPORTATION SERVICES AND THE
TRANSPORTATION BRIGADE IN
THE FIELD ARMY**

	Paragraph	Page
CHAPTER 1. INTRODUCTION		
Purpose and scope	1	3
Establishment of the field army support command	2	3
2. COMMAND AND STAFF RELATIONSHIPS		
Theater army	3	4
Theater army logistical command	4	4
Field army	5	4
Field army support command	6	4
Corps	7	5
Support brigade	8	5
Division	9	5
3. THE TRANSPORTATION BRIGADE		
General	10	7
Mission	11	7
Capabilities	12	7
Functions	13	7
Organization	14	7
The brigade commander	15	8
Transportation brigade headquarters and headquarters company	16	8
4. TRANSPORTATION BRIGADE FUNCTIONS AND UNITS		
General	17	13
Transportation movements management	18	13
The transportation movement control center	19	14
Motor transport service	20	15
The transportation motor transport group	21	16
Air transport service	22	18
The aviation group	23	19
Terminal transfer service	24	20
The transportation terminal transfer company	25	21
Through movement operations	26	21
Highway regulation	27	23
Transportation planning	28	23
Transportation intelligence	29	24

This manual supersedes those portions of FM 55-4, 22 December 1959, including C-1, 12 July 1963 and C-2, 6 January 1965, and those portions of FM 55-6, 29 September 1961, pertaining to general and special staffs and the organization for combat service support in the field army, that are in conflict with this manual.

	Paragraph	Page
5. TRANSPORTATION BRIGADE RELATIONSHIPS		
Inventory control center (ICC)	30	25
Ammunition brigade	31	25
Medical brigade	32	25
Field army replacement system (FARS)	33	25
Military police brigade	34	25
Civil affairs group	35	25
6. MOTOR TRANSPORT SERVICE IN SUPPORT BRIGADES		
General	36	26
Motor transport units	37	26
Motor transport operations	38	27
7. TRANSPORTATION SERVICE FOR DIVISIONS AND INDEPENDENT CORPS		
Division transportation functions	39	28
Field army support for divisions	40	29
Transportation service for corps troops	41	30
Transportation service for independent corps	42	30
APPENDIX I. REFERENCES	32
II. HIGHWAY REGULATION AND THE HIGHWAY TRAFFIC HEADQUARTERS	34

CHAPTER 1

INTRODUCTION

1. Purpose and Scope

a. This manual provides commanders and staff officers with general guidance for establishing and utilizing transportation service in the field army. It is designed to serve the following specific purposes:

- (1) To provide commanders with a guide upon which to base operational concepts and procedures.
- (2) To provide guidance for users of transportation services and to explain the missions and functions of transportation units to commanders and staff officers at all levels within the field army.
- (3) To serve as a basis of instruction in the Army school system and at unit level by describing transportation units and procedures.

b. This manual covers the mission, organization, and capabilities of transportation service units, with emphasis on the transportation brigade and its major subordinate commands. It delineates the organization for transportation service at the various levels of command in a field army and summarizes transportation operations in combat service support missions. Detailed procedures for the various transportation service operations are contained in FMS 55-10, 55-35, 55-45, 55-46, and 55-56.

c. The material presented in this manual is applicable without modification to both nuclear and nonnuclear warfare.

d. Users of this manual are encouraged to submit recommended changes or comments to improve the manual. These comments should be forwarded direct to the Commanding Officer, U.S. Army Combat Developments Command Transportation Agency, Fort Eustis, Va. 23604, on DA Form 1598

(Record of Comments on Publication) in accordance with the applicable provisions of AR 310-3.

2. Establishment of the Field Army Support Command

a. The field army support command (FASCOM) is a major subordinate unit of the field army. It consists of a headquarters, five armywide services, four support brigades, and miscellaneous units and teams. The armywide services (transportation, medical, military police, ammunition, and civil affairs) are those whose use is based on combat intensity, decision, or terrain. They serve all users in the field army area. The support brigades (three corps support brigades and one army rear support brigade) provide services that are generally limited to units within their geographic area of responsibility.

b. The complete field army support command is designed to support a field army of three corps, of four divisions each, engaged in sustained land combat. For smaller forces or operations of shorter duration, the headquarters and operating units can be tailored to meet the requirements imposed by the size and mission of a force, resource limitations, and environmental conditions. Therefore, the combat service support elements in troop basis and contingency plans will be on a greatly reduced scale as compared with the organizational structure portrayed in this and related field manuals.

c. The establishment of the field army support command and its brigades permits the field army headquarters staff to give primary attention to the tactical aspects of planning and operations. The army staff's relationship to FASCOM headquarters in the combat service support functions parallels its relationship to corps headquarters for tactical operations. However, the field army commander is still responsible for armywide combat service support.

CHAPTER 2

COMMAND AND STAFF RELATIONSHIPS

3. Theater Army

The functions and staff relationships of the theater army and the theater army logistical command (TALOG) insofar as they affect transportation are described in detail in FM 55-6. Broadly stated, the theater army commander is responsible for the use of transport capability allocated to theater army. He establishes policies and priorities as required, and the theater transportation officer supervises and coordinates their implementation.

4. Theater Army Logistical Command

The theater army delegates to the TALOG the responsibility for administering the use of Army allocated transport capability. The TALOG allots this capability, based on requirements, to the army, the communications zone, and intersectional services (services which provide support to both the communications zone and the field army). The TALOG transportation officer is responsible for the operation of the transportation intersectional service. To accomplish this responsibility, he coordinates with the field army support command on—

- a. Operational plans, requirements, and boundaries.
- b. Location of combat service support installations.
- c. Details of requirements within priorities.
- d. Management of transportation movements.

5. Field Army

a. The field army staff includes a command element, a chief of staff, a general staff (to include selected staff advisers), and a special staff. The special staff does not, however, contain a transportation section. Instead, transportation technical personnel have been integrated into the general staff sections. Although the G3 is responsible for the coordination and supervision of tactical troop movements and the establishment of priorities for

allocation of personnel and materiel, transportation operations are primarily centered in the G4.

b. The G4 is responsible for formulating logistics policies, determining requirement allocations and priorities, and developing combat service support plans in coordination with other general staff elements. Such plans include the overall concept for support operations, support requirements, and designation of priorities. Inherent in this responsibility is the review of implementing plans, policies, and directives prepared by the field army support command and the continuing monitoring of the FASCOM's execution of army plans.

c. Major service functions of the G4 include transportation. This function covers the transport of units, personnel, and supplies by all means of transportation; control of troop movements, including selection of routes; highway regulation and surface traffic control; coordination of the use of airlift in support of combat service support operations; and preparation of movement order annexes pertaining to regulation or control of logistical operations.

d. Most movements in the field army rear area are of a combat service support nature and are within the scope of the G4. The transportation specialists in the G4 section assist in determining transportation requirements, in developing highway regulating plans, and in supervising transportation activities throughout the field army. Because of the close relationship between G4 and G3 requirements, these transportation specialists provide advice and assistance as necessary to the G3, who does not require the services of such staff personnel on a full-time basis.

6. Field Army Support Command

a. The FASCOM commander and staff are primarily responsible for planning for and execution of assigned combat service support missions. Although the staff of army headquarters has basic responsi-

bility for broad policy development and for development of support plans, details for implementing policies and detailed evaluation and requirements computations for combat service support for projected plans are usually developed by the FASCOM. Therefore, many combat service support matters that were referred to field army in the past are now referred to the FASCOM headquarters for resolution.

b. The FASCOM staff consists of a command section, a chief of staff section, general staff sections (designated assistant chiefs of staff for personnel; security, plans, and operations; supply; maintenance; services; and civil affairs), and selected special staff sections. As in the case of the field army headquarters, no transportation special staff section is included in the FASCOM headquarters. Transportation technical specialists have been integrated into the general staff sections for supply, maintenance, and services. The transportation brigade is primarily concerned with the functions and responsibilities of the office of the ACofS, services.

c. The FASCOM assistant chief of staff (ACofS), services, administers the allocation and use of army-wide transportation capabilities for accomplishing combat service operations. His functions include—

- (1) Control of movements, to include transportation of units, personnel, and supplies via water, rail, highway, air, and pipeline, as appropriate.
- (2) Local procurement of materiel and services for support of activities of the army and the FASCOM.
- (3) Highway regulation and traffic control.

d. In carrying out his functions, the ACofS, services, depends on the transportation specialists on his staff to recommend movements management policies, to prepare implementing directives, to prepare the FASCOM movements program, and to exercise staff supervision over the FASCOM transportation movements management field organization and the highway traffic headquarters. The transportation specialists also recommend allocations of armywide transport capability for use in tactical mobility, rear area security, and rear area damage control, and they aid in exercising staff supervision over the operations of the transportation brigade. They perform liaison with field army, corps, and support brigades; with supporting forces, such as the

TALOG and Air Force area airlift forces; and, as appropriate, with allied and host-nation transportation agencies.

7. Corps

The general staff functions at corps closely parallel those at field army (para 5), and transportation service responsibilities are similarly divided. The corps general staff evaluates transportation logistical plans submitted by the support brigade for adequacy and applicability to tactical plans. The relationship between the corps and the support brigade is one of supported to supporter. The major interest of corps in the transportation service of the support brigade is to insure that the support brigade is providing combat service support for movements required for the accomplishment of the corps tactical mission.

8. Support Brigade

a. The support brigade ACofS, services, is responsible for coordinating the use of assigned transportation and for requesting additional transport support from the armywide transportation service when required. He coordinates with the movement control center of the transportation brigade to insure adequate movements support for the command and with the corps staff on road clearances and general transportation matters.

b. The ACofS, supply, and ACofS, maintenance, are concerned directly with those respective functions as they pertain to Army aircraft. However, as the transportation brigade has no supply or maintenance functions, the relationship between these two staff sections and the transportation brigade is that of supporting staff to supported unit.

c. It should be noted that none of the staff officers in the support brigade have operational control over the service units in the brigade. The operating units are usually formed into battalions and groups, which are directly subordinate to the brigade commander.

9. Division

a. In the division, transportation estimates, plans, and orders are responsibilities of the appropriate general staff officer. The G3 is responsible for tactical mobility operations and the G4 for logistics and other administrative support.

b. The commander of the division support command, as the division logistics operator, is charged with planning, coordinating, and controlling the

employment of organic, attached, and allocated logistics transport capabilities.

c. The division transportation officer is the chief of the transportation section and is located in the division support command. From this location, he coordinates closely with division and corps general staffs, and the commander of the supply and transport battalion. His primary duties include—

- (1) Preparing division loading plans for administrative moves and, as required, for operational moves, based on the operations and administrative orders prepared by the division general staff.

- (2) Coordinating transportation requirements and requesting necessary support to meet those requirements that are in excess of division capabilities.
- (3) Controlling movements, to include selection of routes, highway regulation, and preparation of march order annexes.
- (4) Within the policies of the division and support command commanders and the authority delegated by them, exercising technical supervision over surface transportation.

CHAPTER 3

THE TRANSPORTATION BRIGADE

10. General

The transportation brigade is a major subordinate unit of the field army support command (FASCOM). It provides armywide transportation service primarily in support of the field army supply and replacement distribution system. However, at the direction of the field army command, it may also provide tactical mobility transport. The FASCOM commander controls the allocation and use of the brigade's transport capability through the FASCOM movements program.

11. Mission

The mission of the transportation brigade is to provide the following services to all users of transportation in the field army area:

- a. Long-haul motor transport and, as required, local delivery of personnel and cargo.
- b. Airlift capability for select cargo, personnel replacements, and patient evacuation, as required.
- c. An augmentation for the operation of the field army highway traffic regulating system.
- d. Movements planning and management for the field army.
- e. Terminal transfer services, as required.
- f. Transport for airdrop of personnel and materiel, as required.

12. Capabilities

The transportation brigade, with its assigned units, has the following approximate daily transport capabilities (see para 21, 23, and 25 for general planning factors):

- a. Movement of 1,350 tons of cargo by air.
- b. Movement of 13,000 tons of cargo by motor transport in long-haul operations.
- c. Transfer of 2,700 tons from one carrier to another. (Included in this capability is the temporary holding of in-transit cargo.)

13. Functions

a. The transportation brigade provides transportation support on an armywide basis, deploying its units throughout the field army to provide line-haul and local transport support, transportation movements management, and terminal services (fig. 2). These functions are conducted as outlined in chapter 4 for the specific organization.

b. Essentially, the brigade transport units provide the connecting link between TALOG transportation intersectional services and direct or general support units of the field army area. The brigade does not have a maintenance mission or a supply mission as such.

- (1) Maintenance functions within the transportation brigade and its subordinate units are organizational in nature. Organic equipment of the brigade consists primarily of vehicles and aircraft. The organizational maintenance of this equipment will be a prime factor in the ability of the unit to accomplish its assigned mission.
- (2) Supply of transportation equipment and repair parts is a function of the support brigades. Commanders of the various transportation units of the transportation brigade are responsible for requesting and maintaining supplies needed to keep their materiel in a satisfactory state of readiness.

14. Organization

(fig. 1)

The transportation brigade consists of a headquarters and headquarters company (fig. 3), a transportation motor transport group, an aviation group, a transportation movement control center, and three transportation terminal transfer companies. A personnel services company is attached to furnish personnel services for all personnel of the transportation brigade and attached units. In order to present the organization graphically, fixed organ-

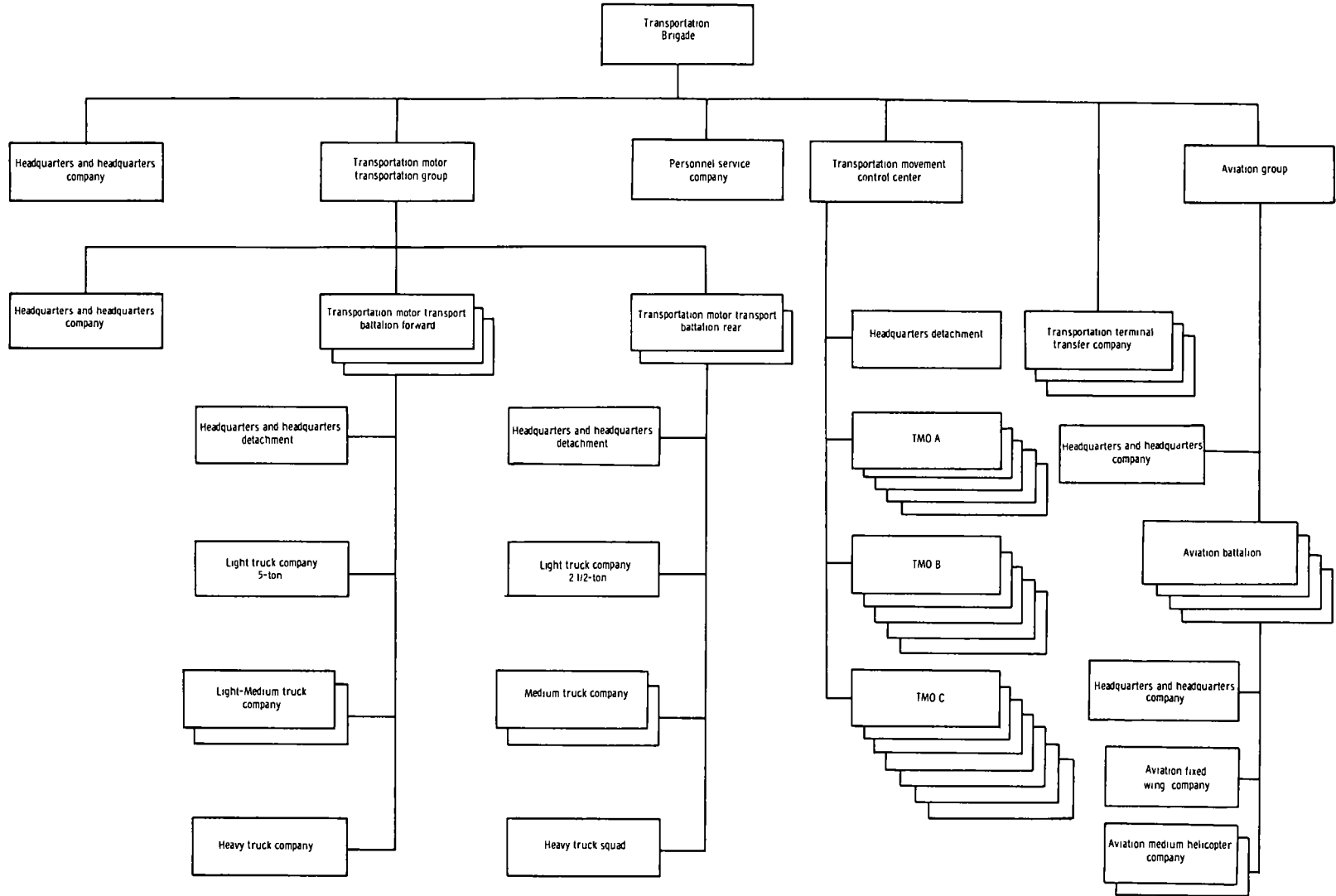

Figure 1. Transportation brigade.

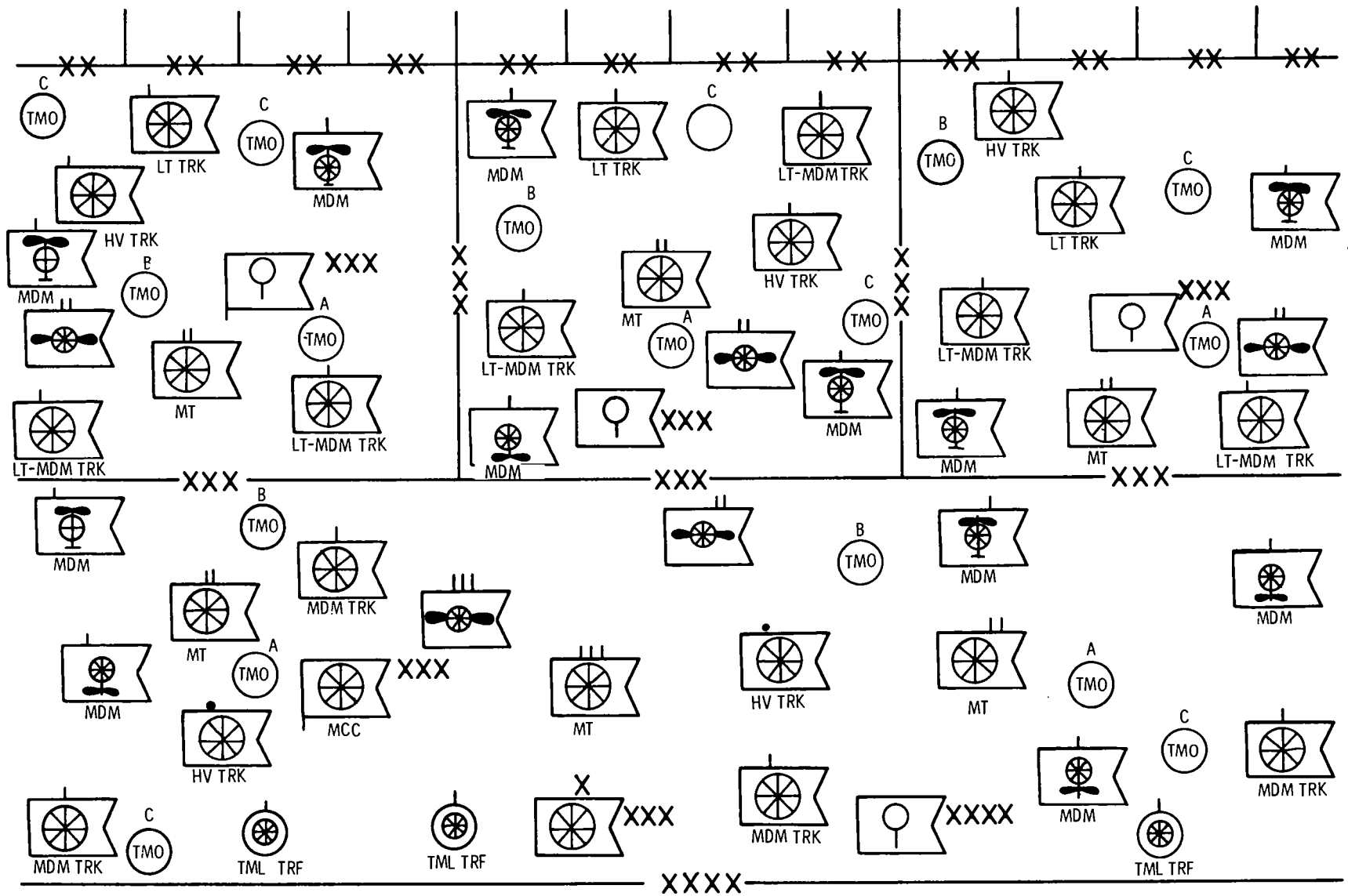

Figure 2. Type deployment of transportation brigade units.

izations are shown in figure 1; however, it must be kept in mind that the basic premise of the entire FASCOM organization is that it can be tailored to suit the situation. The flexibility of organization inherent in the transportation brigade permits rapid organizational adjustment to changing transportation service support requirements.

15. The Brigade Commander

The transportation brigade commander reports directly to the FASCOM commander. Coordination of command and staff matters with higher and supported headquarters normally is conducted through command channels, except that technical transportation matters may be coordinated directly. Since some of the transportation brigade units must operate within division and corps boundaries, the transportation brigade commander may coordinate directly with the field army commander and staff on transportation support of combat operations when so directed and authorized. It is contemplated that this type of staff relationship will be in coordination with the FASCOM ACofS, services, and the field army G4. Such coordination might be required to provide immediate transportation response to a changing combat situation.

16. Transportation Brigade Headquarters and Headquarters Company

The brigade headquarters (TOE 55-62) (fig. 3) includes the commander, an aide-de-camp, a deputy commander, a chaplain, a communication officer, a sergeant major, and commissioned and enlisted assistants organized into S-type staff sections. Staff coordination is a function of the deputy commander. This headquarters, when feasible, is located in the vicinity of the FASCOM headquarters in the army service area and adjacent to major communications facilities.

a. Company Headquarters. The company headquarters is the housekeeping portion of the brigade headquarters. Services include mess, motor maintenance, mail, limited administration, and unit supply.

b. Administration and Personnel Section. The administration and personnel section is supervised by the brigade S1. This section accomplishes headquarters administration, personnel services, and administrative services not appropriately detailed elsewhere. Specific tasks include—

- (1) Operation of mail and distribution center.

- (2) Preparation of correspondence, maintenance of headquarters files, records and reports control, and routine administration.
- (3) Staff supervision of the attached personnel services company and furnishing of personnel services for the transportation brigade.

c. Plans and Operations Section. The plans and operations section is normally supervised by the S3. The section plans for disposition, employment, training, and supervision of subordinate attached and assigned units for the brigade commander. This section has primary responsibility for coordinating the employment of assigned and attached transport and service units to provide an efficient, integrated transportation service. Specific duties include—

- (1) Development and implementation of plans for transportation armywide operations in support of field army and FASCOM operations.
- (2) Development and publication of transportation policies, in consonance with policies of higher headquarters and implementation of directives and procedures to assure compliance with established policies by units and personnel under the jurisdiction of the transportation brigade commander.
- (3) Collection, evaluation, dissemination, and use of transportation intelligence, as appropriate.
- (4) Maintenance of current information regarding operational status, location, capabilities, requirements, and other detailed information regarding all transport or service units assigned or attached to the transportation brigade.
- (5) Direction of unit and individual training as required.
- (6) Establishment of liaison with transportation technical personnel on the staffs of higher and adjacent headquarters.

d. Supply and Maintenance Section. The S4 plans, coordinates, and supervises the operation of supply, transportation (organic), and services within the brigade. Specific functions include—

- (1) Recommending regulating procedures and allocating critical supplies essential to the operations of units assigned and attached to the brigade.

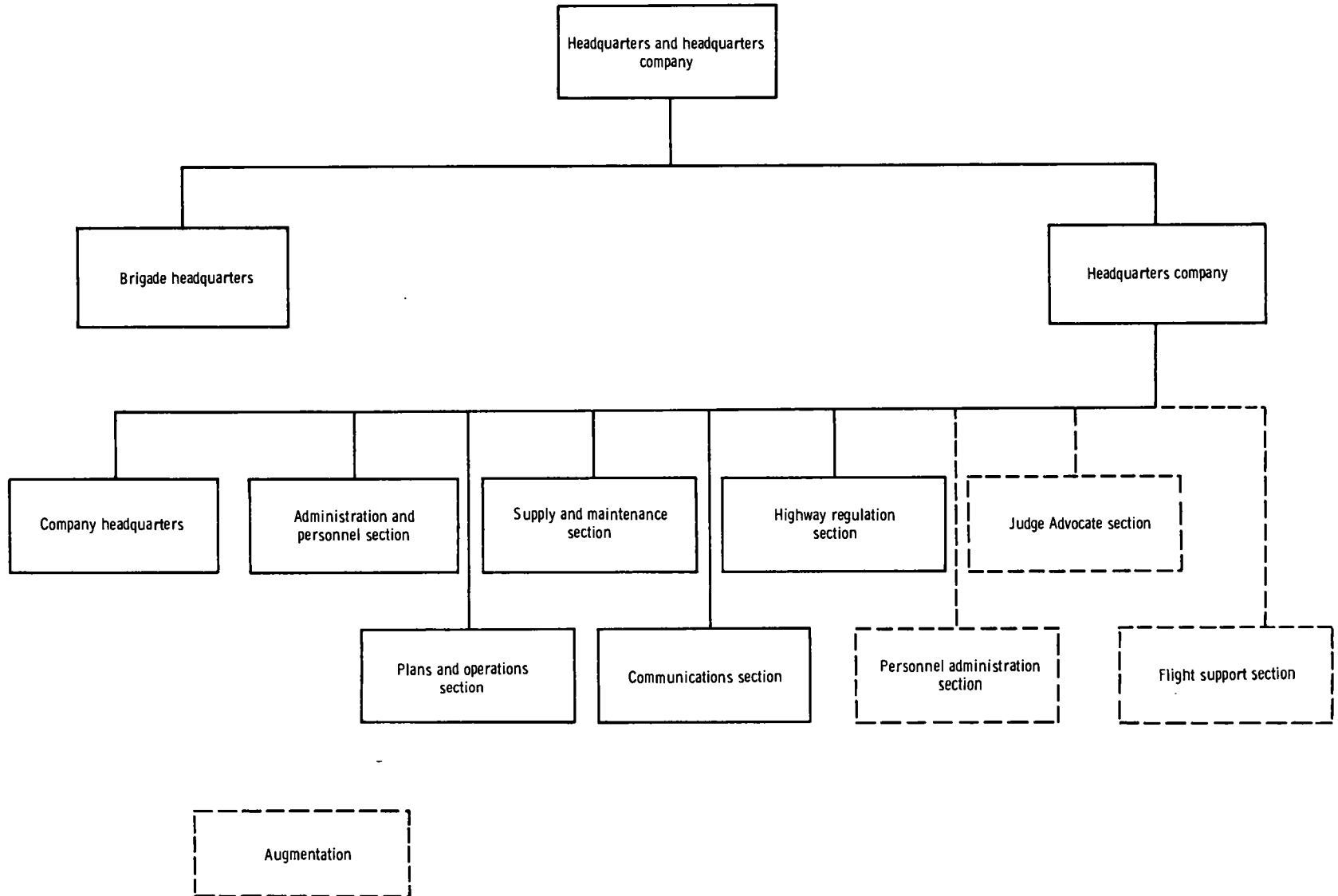

Figure 3. Transportation brigade headquarters and headquarters company.

- (2) Performing frequent and continuous inspections of transportation units to determine status of equipment, stockage, and maintenance facilities.
- (3) Coordinating and supervising general maintenance activities of the brigade and insuring that organizational maintenance is performed in accordance with approved standards and procedures.
- (4) Coordinating with supporting direct support supply and direct support maintenance units.

e. Communications Section. The communications section, under the communications officer, provides 24-hour operation of the brigade's radio, radioteletypewriter, teletypewriter, and telephone communications between brigade headquarters and adjacent, higher, and subordinate headquarters. Specific duties include—

- (1) Preparing signal communication plans in support of the brigade mission.
- (2) Operating and performing organizational maintenance on brigade communications equipment.
- (3) Encrypting and decrypting classified messages.
- (4) Maintaining communications files, records, and reports.
- (5) Preparing brigade signal operation instructions for communications.
- (6) Supervising and inspecting signal communications activities in subordinate units.

f. Highway Regulation Section. The highway regulation section, under the traffic officer, normally does not operate within the transportation brigade. Personnel of this section may supplement the traffic headquarters for army and corps established at FASCOM and corps support brigade headquarters respectively, or they may be used to provide staffing and supervision of highway regulating points at

critical points in the highway network within the field army. Appendix II gives specific duties and details of the establishment and operation of a highway traffic headquarters and highway regulating points.

g. Staff Chaplain. The staff chaplain assigned to the transportation brigade headquarters provides staff and professional supervision of religious activities throughout the brigade. In addition to the staff duties of chaplains as discussed in FM 16-5 and FM 101-5, the brigade staff chaplain performs the following specific functions:

- (1) Furnishes recommendations regarding the assignment and professional utilization of chaplain personnel and their enlisted assistants.
- (2) Develops plans and coordinating procedures for a sustained program of denominational coverage throughout the brigade.
- (3) Develops and coordinates plans in consonance with the overall policies and plans of higher headquarters for area religious coverage.

h. Personnel Administration Section Augmentation. The personnel administration section augmentation provides the necessary personnel technicians and specialists for independent operation and for operation when the brigade is not supported by a personnel services company.

i. Judge Advocate Section Augmentation. The judge advocate section augmentation is authorized when the brigade is assigned general courts-martial jurisdiction and authority to negotiate contracts for civilian transport and to process claims occurring in transportation operations.

j. Flight Support Section Augmentation. The flight support section augmentation operates and performs the organizational maintenance on one staff transport airplane and two observation helicopters when the brigade is not provided air transport support from another source.

CHAPTER 4

TRANSPORTATION BRIGADE FUNCTIONS AND UNITS

17. General

a. The headquarters of the transportation brigade is a planning and control organization. Actual operations within the brigade are carried out by its subordinate units. This chapter describes the functions of the brigade and its units.

b. The components of a transportation service may be compared with the links of a chain. Each unit and function is connected with some other unit or function to form the complete system. Some functions (for example, terminal transfer service) may be performed by only one type of unit. Other functions (for example, planning) may be required of every unit. Therefore, in describing the functions of the brigade, it is necessary to show the relationship of each function not only to the transportation brigade but also to other staffs and operating units.

18. Transportation Movements Management

a. Transportation movements management is the proper use of the capability of each transport mode in accomplishing the commander's objective. A fast, responsive, and reliable transportation system in the field army permits tactical and logistical commanders to maintain lower levels of supply and thus to increase mobility and combat effectiveness.

b. The staff of the assistant chief of staff (ACofS), services, of the field army support command (FASCOM), is responsible for staff supervision of transportation movements. In implementing a sound movements program for the command, the staff insures accomplishment of the following tasks:

- (1) Preparation of a movement plan.
- (2) Supervision of the use of available movement capability.
- (3) Provision of detailed data to support current and future plans for the development of the transportation system.

c. To effectively use the existing daily transport capability, the basic principles of movements must be observed.

- (1) These principles (SOLOG Agreement 27, FM 55-10), equally applicable to the management of transportation services and to the management of movements, are—
 - (a) Control of movements is centralized at the highest level at which it can be adequately exercised.
 - (b) Movements are regulated.
 - (c) Movements are fluid and flexible.
 - (d) Maximum utilization is made of carrying capacity.
- (2) The application of the first principle of movements is readily seen in the assignment of shippers, receivers, and carriers to the FASCOM. This centralizes the control of the elements of movements. By placing the responsibility for movement management at FASCOM, the field army commander is able to coordinate activities of the transport services and users of the services to form an integrated transportation system for the command.
- (3) Regulation of movements within the field army is essential, as the requirement for movement of personnel and materiel often exceeds the capabilities of the transport services to accomplish the movement. This is particularly true when one corps is heavily involved in a tactical effort which must be supported. At the same time, the FASCOM commander is responsible for the movement of that portion of the field army's daily tonnage requirement that is not delivered to forward areas by the communications zone (COMMZ). (Approximately three-quarters of the daily requirement is accomplished by throughout (para 26).)

- (4) Maintaining fluid and flexible movements requires a system that adjusts rapidly and maintains an uninterrupted flow of traffic. Movement decisions are based on the most current information received, and poor communications or untimely information adversely affects the flow of cargo.
- (5) To obtain maximum benefits from the field army's carrying capacity, close supervision is required. Unnecessary transshipment and rehandling of supplies must be minimized. Backhauls and crosshauls are eliminated whenever possible, and turnaround time is held to an absolute minimum.

d. The staff of the FASCOM ACoS, services, is not provided with the necessary personnel to accomplish the movements management mission for the command. This mission requires the assistance of the movement control center of the transportation brigade.

19. The Transportation Movement Control Center

a. Mission. The mission of the transportation movement control center (TOE 55-6) is as follows:

- (1) To plan, program, and control all non-tactical movements in the field army accomplished by armywide transportation resources. This includes the commitment of transportation brigade resources against movement requirements contained in the movements program and those submitted through the transportation movement officers (TMO's). It also includes hauls made by transportation brigade resources in the forward or rear areas or between the two areas.
- (2) To command and supervise assigned or attached transportation movements units.
- (3) To maintain liaison with transportation elements of other U.S. forces and with allied- and host-nation transportation agencies.
- (4) When required, to participate in tactical planning when the use of transportation brigade or host-nation equipment is envisioned.

b. Organization. The transportation movement control center (fig. 1) assigned to the transportation

brigade has a center headquarters, a headquarters detachment, and 11-17 field TMO's. When operating in an extended area, augmentation movement offices are required. When a lesser requirement exists, any combination of appropriate component teams is employed. Teams are located in the field so that all points of origin and destination, as well as critical points in the transportation net, can be observed. They must be in a position to control, concentrate, and divert transportation resources as the situation demands.

c. Functions.

- (1) The primary function of the transportation movement control center commander and his staff is to serve as the central movements management agency for the field army support command. To carry out this function, the headquarters prepares movement plans (*d* below), conducts necessary liaison, supervises the activities of the field transportation movement offices, and insures proper utilization of available movement capability. Details of the functions of the staff and field offices of the movement control center are contained in FM 55-10.
- (2) The functions and duties of the individual TMO's vary with the location, type of service provided by installations, and transport modes served. The following are general duties applicable to all offices:
 - (a) Establishing and maintaining close relationship with service installations and representatives of transport units in the area.
 - (b) Maintaining current information, including location of local units, installations, and supply activities; movement requirements; changes in movement capabilities; and status of the local transport situation.
 - (c) Consolidating nonprogramed movement requirements of local units, installations, and activities and arranging for transport services in connection therewith.
 - (d) Supervising execution by users and operators of the movements program and/or movements instructions issued by the movements staff.
 - (e) Insuring efficient use of transport capabilities allocated by the movements staff.

- (f) Preparing plans, when required, for local employment of transport.
- (g) Coordinating the actions of shippers, transport operators, and receivers.
- (h) When required, receiving and transmitting to the FASCOM highway traffic headquarters convoy clearance requests and sending confirmations of clearances to requesters.
- (i) Determining that all ordered security measures concerning movement of personnel and freight are complied with and that movements are adequately documented.

d. Movements Planning. The basis for the majority of movements planning is the balancing of requirements against capability. Requirements necessary to insure the success of the operation will be submitted by all users of transportation services in the field army, normally to the movement control center. Capability consists of the units, equipment, and facilities available, together with the method and procedures for utilizing them for the accomplishment of the requirements. The movement control center headquarters receives information on the total capability of the transportation brigade from the two transport groups (motor and air). On the basis of information from his TMO's dispersed throughout the command and of his knowledge of requirements, the movement control center commander advises the transportation brigade command on the allocation of transportation resources within the field army.

- (1) *Movement requirements.* Initial requirements are based on operational plans available and on tonnage requirements and distances known from previous experience. Users should be encouraged to submit advance estimates and to refine them as additional information becomes available. As planning progresses, tonnage is defined by classes of supply and distances are measured between specific origins and destinations.
- (2) *Movement capability and resources.* The FASCOM and movement control center planners have a relatively constant transport capability to deploy, though resources are gained or lost as a result of enemy action or of relocation to a different area of

operations. Basically, the resources available to planners are as follows:

- (a) Assigned and attached transport services.
 - (b) COMMZ transport services made available for use within the field army.
 - (c) Civilian transport services allocated for military use.
- (3) *Balancing requirements and capability.* Once the movement requirements are compared with the transport capabilities, shortages of capability are of primary concern to planners. The key to completing the planning is the priority established by the FASCOM (or field army) commander to determine which units or commodities will receive first call on the transport available. Once the priority is established, the planner can consider all other possibilities of moving the requirements of units or commodities with low priority.

20. Motor Transport Service

a. General. The motor transport service of the field army support command is an integral part of the transportation system designed to link the COMMZ to the forward combat elements. It plays a major role in all operations undertaken by the field army, tactical or logistic, the degree of participation depending on restrictions imposed by the operational environment. The capacity of the motor transport service must be efficiently employed to transport the large tonnages of ammunition, POL, and general supplies needed to sustain the present-day field army and to insure the success of the operation being supported. In the field army support command, the transportation brigade's motor transport group and its subordinate elements provide the armywide motor transport service.

b. Organization.

- (1) In planning the organization of the motor transport service of the FASCOM transportation brigade, the basic considerations have been—
 - (a) Expected tonnage to be moved.
 - (b) Probable size, density, and packaging of cargo to be moved.
 - (c) Probable road surface and distance over which cargo is to be hauled.
 - (d) Problems of command.

- (2) As a consequence of the above considerations, the mix of units in the battalions of the transportation brigade has been tailored to expected conditions of employment (fig. 1). In the forward battalions, 5-ton truck companies are provided for the smaller lots (and possible off-road movement) of ammunition, and a heavy truck company is provided for the movement of large numbers of tracked vehicles. The rear battalions are provided with medium truck companies for the long haul on-highway movement of larger volumes of class V, and the requirements for the movement of heavy tracked vehicles are met by the inclusion of a heavy truck squad rather than a company.

c. *Employment.*

- (1) The motor transport group of the transportation brigade is employed on the pooling principle. The group and battalions which are dispersed in the army area provide centralized control for this pool of vehicles. Pooling of vehicles provides a mix of task vehicles by type with the capability of performing various missions that may arise. Maximum use of the vehicles is obtained when they are committed by the centralized movement control center for the use and benefit of a number of units having a recurring, but not constant, requirement for transport. (Vehicles assigned directly to the support brigades are not pooled and are employed on a daily basis to perform the continual recurring mission of the brigade.)
- (2) The movement control center commits the overall capability of the armywide motor (and air) transport against the requirements submitted for inclusion in the movements program. As the movements program usually covers a 7-day period, bulk allocations of transport are made by the movement control center to cover the entire period. The on-the-spot commitment of capability to a particular shipment (either programmed or, if the priority warrants, nonprogramed) is made by the local TMO. While shipments should be programmed to the maximum possible extent, as combat service support moves toward the

division areas, the number of nonprogramed shipments increases. The field TMO's are given the widest possible operational latitude to accomplish these moves within the centralized control of the movement control center.

21. The Transportation Motor Transport Group

a. *General.* The mission, assignment, and capabilities of the motor transport group and its subordinate units are described in this paragraph in very general terms and are related to their employment in the field army with emphasis on their placement in the transportation brigade. Detailed capabilities and functions of all motor transport units, assignment, variations of equipment, techniques of their employment, and procedures used in planning, executing, and controlling motor transport operations are contained in FM 55-35.

b. *Headquarters and Headquarters Detachment (TOE 55-12).*

- (1) *Mission and assignment.* The mission of the headquarters and headquarters detachment, transportation motor transport group, is to provide command, staff planning, and control of operations of motor transport battalions and attached units. Its assignment is to the FASCOM transportation brigade where, with its attached units, it provides the armywide motor transport service.
- (2) *Capabilities.* The motor transport group is capable of planning, coordinating, and supervising attached units engaged in operational assignments such as local or line hauls or other motor transport missions.
- (3) *Functions.*
- (a) The group headquarters plans for the most economical and efficient use of motor transport equipment assigned to subordinate units. (The group has no task vehicles of its own.) Plans must be made in conjunction with the appropriate traffic headquarters for the most complete and effective use of the highway network. Such plans normally contain an operational analysis with a tabulation of tasks for subordinate units, designated routings for supply hauls if necessary, and road movement tables and graphs

that fit the schedules of individual units into the overall operation and traffic plan. These plans form the basis for orders issued to operating units.

- (b) In fitting capabilities of attached units to operational requirements, the group headquarters coordinates closely with the movement control center and the transportation brigade. In addition, it coordinates with the following activities:
1. The supporting direct support group in obtaining the required supply, issue, and maintenance of equipment.
 2. The military police in traffic control matters.
 3. The appropriate engineer unit for route construction and maintenance.
 4. The appropriate civil affairs agency for relations with civil authorities.
 5. All combat service support activities with regard to location of depots, access roads to installations, and loading and unloading facilities and capabilities.

c. Transportation Motor Transport Battalion (TOE 55-16).

(1) *Mission and assignment.*

(a) The mission of the headquarters and headquarters detachment, transportation motor transport battalion, is to provide command and supervision of units engaged in all types of motor transport. These include direct support of tactical units, supply activities, and terminal operations, and local and line haul operations.

(b) There are five motor transport battalions attached to the motor transport group of the transportation brigade. These battalions are located in the field army forward and rear areas, normally in the immediate vicinity of the largest users of transportation.

(2) *Capabilities.* The headquarters and headquarters detachment, transportation motor transport battalion, is capable of commanding and providing administrative support (except personnel) for three to seven transportation truck and/or tracked vehicle companies.

(3) *Functions.* The battalion headquarters plans and schedules the tasks of subordi-

nate units to conform with the overall movements program and with operational requirements. (The battalion has no task vehicles of its own.) It supervises, coordinates, and assists subordinate units in administration, supply, maintenance, training, and communications.

d. Transportation Truck Companies.

(1) *Mission and assignment.*

(a) The mission of each of the truck companies in the transportation brigade is to transport personnel and matériel in support of field army operations.

(b) There are four basic types of truck companies (light, light-medium, medium, and heavy) in the motor transport group. These companies are attached to the forward and rear motor transport battalions of the motor transport group (fig. 1).

(2) *Capabilities.* The capabilities of the light-medium and heavy truck companies are relatively fixed, but the capabilities of the light and medium companies vary with the type of equipment they are supplied to accomplish their mission. Table 1 contains information which may be used for planning purposes to estimate the availability and transport capability of the various types of truck companies.

(3) *Functions.* The basic element of the motor transport service is the truck company. Each company is designed to be self-sustaining and capable of carrying on sustained operations independently. The commitment of the transport capability of the company is normally received from the motor transport battalion to which the company is attached. The company is responsible for determining which task vehicles will be employed. Each company has in the headquarters the personnel necessary to plan for, direct, and control the employment of task vehicles of the company. Specific functions include—

(a) Providing vehicles to meet operational commitments.

(b) Performing organizational maintenance on unit equipment.

(c) Maintaining necessary records and reports on equipment and operations.

Table I. Unit Capabilities (TOE) of Transportation Truck Companies¹

Type of truck company	TOE	Type of equipment	Pieces of equipment authorized	Pieces of equipment available	Local hauls		Line haul	
					Trips per day	Tons or gallons per day	Trips per day	Tons or gallons per day
Light	55-17	2½-ton truck	60	45	4	720	2	360
		5-ton truck	60	45	4	1,080	2	540
Light-medium	55-67	5-ton tractor	10	7				
		12-ton stake and platform semitrailer	20	14	4	360	2	192
Medium	55-18	2½-ton truck	60	45	4	720	2	384
		5-ton tractor	60	45				
		12-ton stake and platform semitrailer	120	90	2	2,160	1	1,080
		5,000 gallon tank semitrailer	60	45	4	900,000	2	450,000
		7½-ton reefer semitrailer ²	60	45	2	1,080	1	540
Heavy	55-28	10-ton tractor	24	18				
		50-ton transporter ² ...	24	18	3	2,700	1	900

¹ See FM 55-35 for detailed planning information on overload, off-highway, maximum sustained, and other types of operations.

² Tonnage factors are based on average weight of load rather than on vehicle capacity in tons.

22. Air Transport Service

a. General. The air transport service of the field army support command is, like the motor transport service, an essential element of the complete transportation system. The air transport service provides logistic airlift, to include airdrop, for the movement of supplies and personnel in the army area and, if directed, to provide direct support to combat forces for a particular movement. The ability of the air transport service to transport personnel and materiel at comparatively high speeds and with little regard to natural obstacles generates a high demand for use of its resources. Normally, there are never enough aircraft to satisfy all requirements. To counter this situation, all the aircraft assigned to armywide service support are under the control of the FASCOM, assigned to the aviation group in the transportation brigade.

b. Organization. The air transport service is organized along conventional lines (group, battalion, company) (fig. 1), and individual units are located in areas where the greatest demands for their services originate (fig. 2). The primary command element (group) is normally located in a forward area. The organization is flexible; the aviation group allocates aircraft units and assigns missions to the aviation battalions. This allocation is based on the type of mission and/or requirement established by the FASCOM commander and is processed through

the movement control center. The allocation of aircraft units is normally in accord with aircraft characteristics and with the most efficient employment.

c. Employment.

- (1) The air transport service may be employed as a unit, by individual battalion, by individual company, or by a combination of the group's assigned or attached elements. The group receives daily logistic airlift requirements based on priorities established by the FASCOM commander. These requirements are processed at the FASCOM movement control center and forwarded to the aviation group, or appropriate element, in accordance with established movements procedures. To insure maximum utilization of available aircraft, the movement control center requires current and forecast air transport capability. These may be obtained by establishing an aviation group liaison officer at the movement control center or by the development of reports to provide such data.
- (2) The heavy demand for use of the airlift capability of the air transport service makes centralized control desirable. The complex transportation requirements of a modern mobile army demand overall planning, coordination, and control of opera-

tions to achieve an acceptable degree of economy and freedom of utilization. When aircraft are employed in their primary role of combat service support, they operate as outlined in (1) above. When they are directed to a tactical support operation (combat support role), they operate under the control of the tactical commander of the force supported for that particular movement. The tactical commander is then responsible for their proper utilization and for their prompt return to FASCOM control at the completion of the lift.

- (3) Aviation units (or aircraft) may be employed to supplement Army medical service aeromedical evacuation in the field army area.
- (4) Aviation units may be employed in independent operations. However, special consideration must be given when the unit is deployed separately and when the normal combat service support troops and area logistical support points are limited or nonexistent. In these situations, additional support must be planned for and provided simultaneously with the deployment of the unit.

23. The Aviation Group

a. General. The mission, assignment, and capabilities of the aviation group and its subordinate units are described in this paragraph in very general terms and are related to their employment in the transportation brigade. Detailed capabilities and functions of all air transport units, techniques of their employment, and procedures to be used in planning, executing, and controlling their operations are contained in FM 55-46.

b. Headquarters and Headquarters Company (TOE 1-252).

- (1) *Mission and assignment.* The headquarters and headquarters company, aviation group, is assigned to the FASCOM transportation brigade. It has the mission of commanding, planning for, and supervising the activities of assigned or attached aviation battalions. It provides the armywide air transport service.
- (2) *Capabilities.* The headquarters and headquarters company has the capability of plan-

ning, coordinating, and supervising attached or assigned units engaged in operations of combat service support, combat support, aeromedical evacuation, or other air transport missions. The optimum capability of this group and its assigned units is based on 75-percent aircraft availability moving 1,344 short tons daily, or the group can provide sustained combat support based on the air landing or airdrop of 100 short tons of cargo per division (12 in the type field army) per day over a radius of 75 miles.

- (3) *Functions.* As a major subordinate unit of the transportation brigade, the group headquarters provides the command, staff planning, and control for assigned aviation battalions. In addition, the group headquarters coordinates, inspects, and supervises the following operations:
 - (a) General area site selection for subordinate units.
 - (b) Air transport operations, including determination of available capability, assignment of missions to the battalions, and command control of lifts requiring two or more battalions.
 - (c) Establishment of assignment priorities for available maintenance float aircraft.

c. Aviation Battalion (TOE 1-256).

- (1) *Mission and assignment.* The headquarters and headquarters company, aviation battalion, is assigned to the aviation group. Its mission is to provide command, control, staff planning, and administrative supervision for assigned and attached units.
- (2) *Capabilities.* The headquarters and headquarters company, aviation battalion, is capable of commanding and providing administrative support for two to seven aviation companies.
- (3) *Functions.* When the battalion is attached to an aviation group, the battalion headquarters functions as a control headquarters for the employment of attached or assigned aviation companies. The battalion or its elements normally receive daily logistic transport requirements from the group but may be attached to or placed in support of assault forces when the primary mission is tactical transport. The bat-

talion also performs the following specific functions:

- (a) Supervision of organizational maintenance and logistic functions of assigned and attached units.
- (b) Operational support on missions involving two or more subordinate units.

d. Aviation Medium Helicopter Company (TOE 1-258).

- (1) *Mission and assignment.* The mission of the aviation medium helicopter company is to provide tactical and logistic airlift for movement of supplies and personnel in the combat zone. There are eight such companies assigned to the aviation group. The type of medium helicopter assigned will vary as new types become available in the system; however, the task of providing the link between airstrips suitable for conventional airplanes and forward unimproved areas will remain the same.
- (2) *Capabilities.* As a maximum effort, the medium helicopter company can transport in one lift, with all helicopters available and operating, and within 75 nautical miles, the following:
 - (a) With 16 CH-37 helicopters: 368 troops, or 46.4 tons of cargo, or 384 liters.
 - (b) With 16 CR-47 helicopters: 528 troops, or 64 tons of cargo, or 384 liters.
- (3) *Functions.* The medium helicopter company provides the helicopter lift capability of the transportation armywide service system. It receives its commitments for daily operations from the aviation battalion or from such other source as is provided by pertinent transportation movements procedures. In addition to the normal transport and organizational maintenance functions, the company may perform the following specific functions:
 - (a) Operation of one heliport with facilities for visual or instrument terminal air traffic control.
 - (b) When equipped with CH-47 helicopters, transporting the Pershing missile system.
 - (c) Augmenting the Army medical service aeromedical evacuation elements.

e. Aviation Fixed Wing Company (TOE 1-257).

- (1) *Mission and assignment.* The mission of

the aviation fixed wing company is to provide tactical and logistic airlift for movement of supplies and personnel in the combat zone. There are four of these units assigned to the aviation group of the transportation brigade.

- (2) *Capabilities.* In a single lift the fixed wing company is capable of transporting, for air landing or airdrop, with all CV-2 type airplanes available and operating, within a radius of 150 nautical miles, 368 troops, or 50 tons of cargo, or 288 liters. These capabilities allow the unit to provide logistical support of frontline troops in an emergency. However, for sustained operations, these capabilities are reduced or adjusted by an airplane availability factor which varies with the duration of such an operation.
- (3) *Functions.* The fixed wing company provides the conventional airplane lift capability of the transportation armywide service system. The company may receive its commitments for daily operations from the aviation battalion or from some other source, dependent on the transportation movements procedures of the area where the company is employed. In addition to its normal transport and organizational maintenance functions, the company may perform the following specific functions:
 - (a) Provide transport for airdrop operations.
 - (b) Augment aeromedical evacuation elements of the Army medical service.
 - (c) Operate one airfield with facilities for visual and instrument terminal air traffic control.
 - (d) Transport the Pershing missile system.

24. Terminal Transfer Service

a. General. Terminal transfer service consists of shifting cargo from one mode to another or from a type of transport within a mode to a different type at intermediate points within the transportation system. This service, provided by terminal transfer companies, is required at rail, air, motor transport, and water terminals. As the field army does not usually operate ports, the requirement for water terminal transfer service is limited to inland waterways. Terminal transfer service is part of the transportation armywide service system which provides

the connection between COMMZ agencies and the combat forces. As these terminal transfer companies operate at intermediate points in the transportation system, they are not normally assigned to load or unload cargo at the origin or final destination of a movement. These functions are responsibilities of the shipper and the receiver respectively.

b. Organization. Terminal transfer companies are organized into three platoons capable of operating separately at different terminals. They are staffed and equipped to transship cargo at inland terminals, including unloading, repackaging, temporary holding, documenting, and loading cargo wherever a change in transportation mode occurs.

c. Employment. Three terminal transfer companies are assigned to the transportation brigade. This assignment facilitates their attachment to mode operators within the field army. The terminal transfer company or its elements are placed wherever required in the corps and army rear areas. Considering that the majority of cargo transfer activities take place in conjunction with highway or air moves, terminal transfer companies are usually attached to the aviation or motor transport group. When this type of attachment takes place, it is on a mission basis and operational control of the unit falls to the unit having primary transport responsibility.

25. The Transportation Terminal Transfer Company

a. Mission and Assignment.

- (1) The mission of the transportation terminal transfer company (TOE 55-118) is to transship cargo at inland terminals in the field army area. This includes unloading, repackaging and temporary holding if necessary, documenting, and loading cargo wherever a change in transportation mode occurs.
- (2) The terminal transfer company is assigned to the transportation brigade. Normally the company or its elements are further attached to a motor transport or aviation group. This attachment is on a mission basis and provides the group to which attached with the necessary cargo transfer capability.

b. Capabilities. The terminal transfer company can transship 900 short tons of cargo daily (300 short tons per terminal transfer platoon). This tonnage is based on full-strength company opera-

tions in a 20-hour day and takes into account all procedures incident to the movement of cargo. A terminal transfer platoon retains its capability when it is detached from the parent company.

c. Functions. The terminal transfer company provides the necessary personnel and equipment to load, unload, and document cargo. When required, it can hold shipments for short periods, but this function is normally undertaken only when a consignee is unable to accept a shipment on a scheduled delivery date. An example of this would be the inability of an artillery battalion to receive and unload transport while the battalion is moving from one location to another. Details of the functions and methods of operation of a terminal transfer company are contained in FM 55-56.

26. Through Movement Operations

a. General. Throughput is the term used to describe the movement of personnel and supplies to destinations as far forward as possible without intermode or intramode transfers that involve rehandling of cargo. The transportation brigade is particularly concerned with this operation as the number and types of units in the brigade are largely determined by the success of the communications zone in meeting throughput goals. The goals for support of the field army are as follows:

- (1) The COMMZ will deliver about three-fourths of the daily requirement for classes I, II, IV, and packaged III supplies direct to general support and direct support levels in the army forward areas. It is expected that about one-fourth of this amount will bypass to the direct support level.
- (2) General support units will ship to the direct support level with about a 25-percent bypass to battalion user level.
- (3) COMMZ transportation will deliver about three-fourths of the daily ammunition resupply to general and direct support units in the corps area. The daily flow pattern of conventional ammunition in a corps slice is shown in figure 4. (The armywide transportation service may make unit distribution of ammunition to artillery units operating in the division areas.)

b. Unitized Cargo. The throughput goals outlined in *a* above and the allocation of vehicles and equipment to and within the field army support command

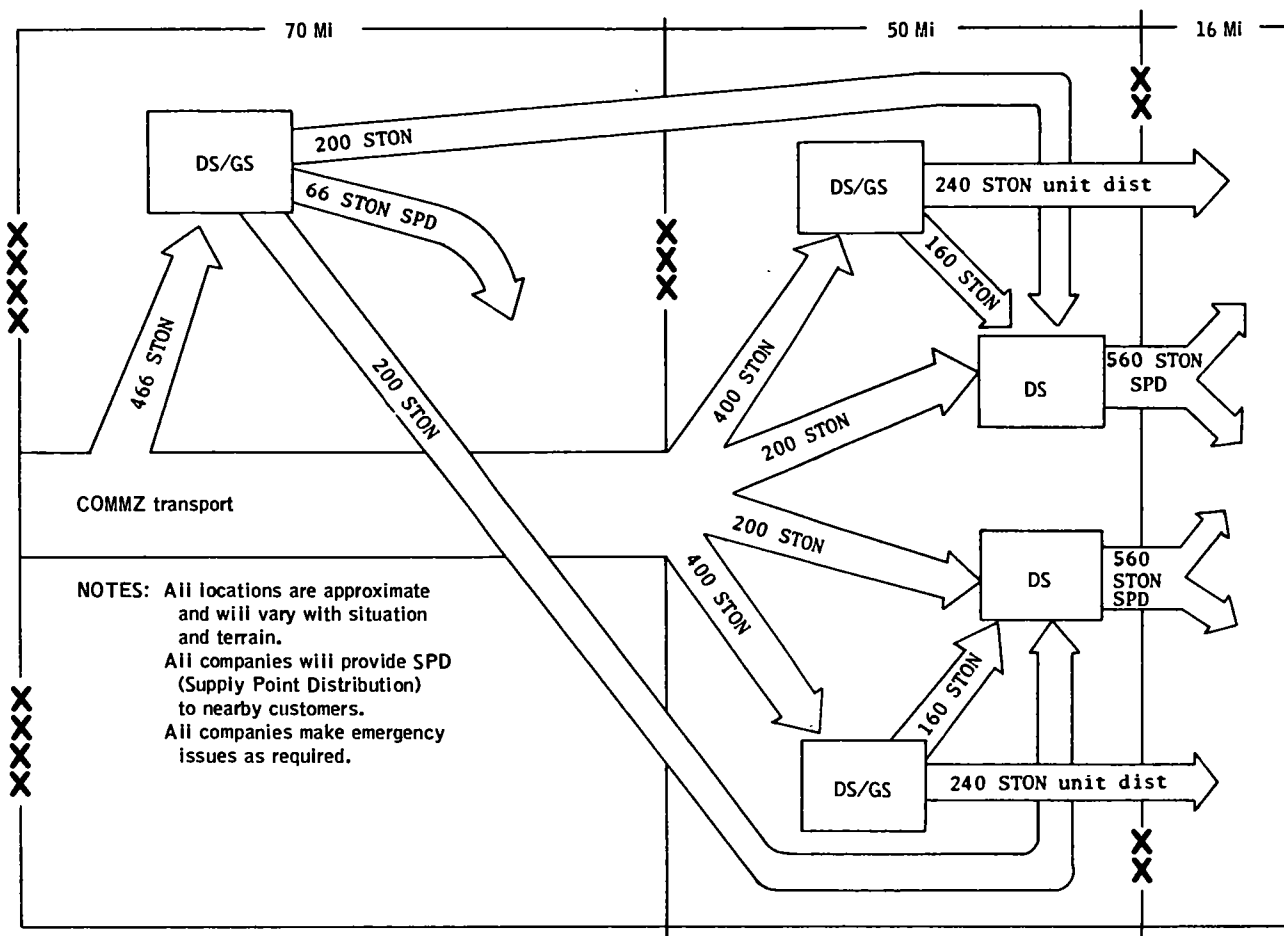

Figure 4. Daily flow pattern of conventional ammunition, one corps slice.

are based on the principle of unitizing cargo. This principle requires shipment of cargo for the same area or unit in the field army to be consolidated by the COMMZ or CONUS shipping agencies. This may be done by using special trucks or containers or by securing the cargo on pallets capable of being moved by forklift trucks. From the Continental United States (CONUS), the unit pack is transported to the COMMZ by the appropriate mode, depending on the type of cargo and the movement priority. In the COMMZ, the terminal (or shipping depot or activity) loads the unitized cargo to the mode that will be used to transport it to the field army. The cargo is not broken down or removed from the unit pack until it arrives at final destination in the field army. It is anticipated that about 50 percent of all classes of dry cargo will be unitized or palletized and loaded and unloaded with materials handling equipment. Therefore, general support, direct support, and battalion users are

organized and equipped to handle unitized or loose cargo. The location of materials handling equipment is a factor in determining the type of transportation (within modes) required for the movement. Such determination will also require continued coordination among supply, transport, and transportation movements personnel.

c. Trailer-Movement Techniques. Through movement of cargo from the CONUS shippers to units in the field army can be accomplished by a variety of methods. Shipping techniques that utilize the tractor-trailer to provide unitization and to accomplish throughput are described below. Ideally, the CONUS supplier of a commodity would load a military trailer; the trailer would be moved to the CONUS port by flatcar or by conventional tractor and loaded aboard a vessel, either roll-on, roll-off, or lift-on, lift-off. The ship would transport the trailer to a COMMZ port, where it would be off-

loaded and moved directly to the ultimate user of the commodity.

- (1) *Trailer-on-flatcar (TOFC)*. The trailer-on-flatcar technique, also referred to as piggyback, takes advantage of existing rail facilities by transporting trailers on rail flatcars. This procedure may be used in CONUS from the shipper to the port and in the theater of operations from the port to forward areas in the COMMZ or to the field army.
- (2) *Roll-on, roll-off (RO-RO)*. The roll-on, roll-off technique provides a method of transporting loaded trailers on specially designed ships from CONUS to COMMZ and vice versa. A tractor pulls the trailer on board the ship and leaves it to be pulled off at the oversea port by another tractor.
- (3) *Lift-on, lift-off*. The lift-on, lift-off technique (also referred to as fishyback) is a method of transporting trailers and/or demountable trailer bodies or containers on specially designed or converted ships. The trailers or containers are normally lifted on and off by special-purpose ship cranes, which also lower them into the ship or onto the weather deck. (Heavy lift gear integral to the ship can also be used to load or unload the container.) The efficiency of this technique depends largely on the use of modular-sized containers, stowage in compatible ship compartments which eliminate or decrease the requirement for tiedowns and dunnage, and availability of a sufficient number of trailer chassis at destination.

27. Highway Regulation

Highway regulation is the coordination of the use of the road net to meet military requirements by vehicles, personnel, and animals. Highway regulations, a responsibility of the commander having area jurisdiction, is accomplished by planning, routing, and scheduling movements on the available road net in accordance with priorities established by the commander. The function of highway regulation is accomplished by the establishment of a highway traffic headquarters by the commander having area jurisdiction under the supervision of the G4 or ACofS, services. Though the transportation brigade is not responsible for highway regulation as it has no area jurisdiction, personnel of the highway regu-

lating section of the brigade headquarters are available to augment the traffic headquarters for field army and corps and to establish highway traffic regulating points in the field. A comprehensive discussion of highway regulation, of the functions of a traffic headquarters, and of the forms and techniques used in highway regulation is contained in appendix II.

28. Transportation Planning

a. General. Planning is a major function of all staff levels. As previously stated, the organization of the field army command has shifted most of the responsibility for transportation planning to the FASCOM staff and the transportation brigade staff. This does not relieve the field army and corps staffs of the responsibility for planning, but it allows them to concentrate their efforts on the tactical aspect of operations.

b. Planning for Base Development. A base development plan is the plan for the improvement and expansion of the resources and facilities of an area to support military operations. The theater commander is responsible for base development planning. Transportation personnel on the staffs at field army and lower headquarters may be required to submit feeder data to base development staff planners of higher headquarters concerning proposed development of facilities in their areas. The requirement also exists for the staffs of field army, FASCOM, and transportation brigade to be aware of any proposed development in their areas when planning current and future operation. Base development planning is discussed in detail in FM 100-10.

c. Planning for Current Operations. Staff transportation personnel are engaged in planning on a daily basis. Provisions must be made for loss of capability, for gains in facilities, and for improving existing procedures to take advantage of circumstances that allow smoother operations. Current operations planning is the routine management necessary to assure continued, efficient operations. This planning provides for the operation of the staff section and for normal procedures to be followed. Yet it must be flexible enough to permit variation from the norm when necessary.

d. Planning for Future Operations. In planning for future operations, the time element dictates the amount of detail allowed. Future operations include both new operations and new phases of current

operations. If time permits, the plan for a new operation should be comprehensive and carefully prepared and should take into consideration all details of the proposed action.

- (1) Planning should be started as soon as possible after the receipt of information on a proposed new operation. Initially, most of the plan is based on assumptions and estimates. Data for general computation of troop requirements, equipment, and facilities are found in FM 55-15 and FM 101-10. As the date of the operation approaches and operational plans are being completed, firm data become available and the plan may be revised as necessary.
- (2) Planning for a new phase of a current operation may include a completely new study, but generally it does not require more than realignment of the units concerned. It must take into consideration the facilities available at the time the plan is to be executed. Reports of operational experience from the units participating in the current operation are invaluable in the preparation of the plan for the new phase.

29. Transportation Intelligence

a. Transportation intelligence is the product resulting from collection, evaluation, interpretation, analysis, and integration of all available information about air, land, and water transportation systems of foreign areas of operation that are of immediate or potential military significance. This intelligence includes data on the characteristics, condition, development, operation, maintenance, and construction of transportation system and facilities. Transportation intelligence within the field army is divided into two major fields of interest: technical intelligence pertaining purely to transportation materiel and general intelligence pertaining to all other transportation areas of interest.

- (1) To provide complete technical intelligence in the field army, a technical intelligence company has been established as a direct subordinate unit of the field army military intelligence battalion. The unit operates under the staff supervision of the ACofS, G2. Transportation is represented

by a section in the company; this section performs the following functions as part of the coordinated effort:

- (a) Collects, examines, evaluates, and classifies enemy transportation equipment.
 - (b) Prepares technical intelligence reports and maintains files and records to include item-wanted lists and technical intelligence target lists.
 - (c) Provides teams to examine material in the forward areas when the items cannot be evacuated to the center.
 - (d) Assists in the interrogation of selected prisoners of war by providing interrogators with requests for information and guidance as pertains to transportation equipment, methods, and procedures; evaluates the information derived therefrom and produces intelligence data from it.
 - (e) Maintains close liaison with other organizations in the field army area.
- (2) All transportation personnel are charged with the responsibility of collecting information; however, the transportation portions of staffs at all headquarters, transportation units of the field army, and technical intelligence teams are the primary agencies involved in the collection of information. Transportation units or personnel may be assigned special collection or reporting tasks in addition to their normal intelligence responsibilities. Transportation information is also collected by other technical services and by United States Air Force and Navy intelligence agencies.

b. Intelligence may be used as a basis for command decisions, and it must be available in sufficient time to be useful. The primary objective of dissemination is the timely placing of intelligence in the hands of the ultimate user for the formulation of capability estimates and operational plans. Intelligence required by specific staff sections or units is disseminated to them through staff, technical, or command channels. Technical intelligence collection and dissemination are fully explained in FM 30-5 and FM 30-16.

CHAPTER 5

TRANSPORTATION BRIGADE RELATIONSHIPS

30. Inventory Control Center (ICC)

The organization of the inventory control center complements the transportation brigade movement control center as the information available through the use of automatic data processing equipment is invaluable to movement planners. Close coordination between movement planners and appropriate stock management branches of the inventory control center provides data in the form of print-outs on the status of supplies arriving in, or to be shipped within, the field army and of unserviceable supplies to be evacuated. This information is required in planning distribution and allocation of mode capability. Responsibility for requesting (through command channels) the information available from the inventory control center rests with the movement control center. The nature of the inventory control organization does not provide for dissemination of the vast quantities of available technical data to any service that might have a requirement.

31. Ammunition Brigade

The relationship between the transportation brigade and the ammunition brigade is extremely close. Both the ammunition brigade and the transportation brigade provide critically important armywide services to the field army. The ammunition brigade is dependent on the transportation brigade for both information on and coordination of COMMZ vehicles delivering in the field army area and for direct transportation support in the movement of ammunition with transportation brigade vehicles. Transportation movements management personnel are in continuous contact with personnel of the ammunition brigade regarding the transport of their items of individual responsibility.

32. Medical Brigade

The relationship between the transportation brigade and the medical brigade is primarily one of support. Aircraft assigned to aviation units of the transportation brigade can be converted for patient evacuation. Requests for medical evacuation support are transmitted to the transportation move-

ment control center by the most expeditious means. At the movement control center, requirements are balanced against available transport aircraft capability and are met in accordance with established priorities.

33. Field Army Replacement System (FARS)

The relationship between the field army replacement system and the transportation brigade is again one of support. The staff element of the field army replacement system (field army G1) is responsible for providing the FASCOM movements element with bulk movement requirements. These requirements are processed by the movements personnel and are fulfilled in accordance with available capability and established priorities.

34. Military Police Brigade

The command and staff relationship between military police brigade and transportation brigade personnel must be one of close coordination. The responsibility for highway regulation has been assigned to the FASCOM ACofS, services. This responsibility is discharged through the traffic headquarters, a staff agency primarily manned by transportation brigade personnel. The traffic headquarters performs all appropriate highway regulating staff actions and has operational control over highway regulation operating elements. The necessity for complete coordination between highway regulation and traffic control agencies requires full-time transportation and military police representation in the traffic headquarters.

35. Civil Affairs Group

The relationship between the civil affairs group and the transportation brigade is one of mutual support. Civil affairs movement requirements are submitted to the movement control center to be processed in the normal manner. Civil affairs transportation personnel and transportation brigade personnel use available civilian transport capability within the existing priorities established by FASCOM.

CHAPTER 6

MOTOR TRANSPORT SERVICE IN SUPPORT BRIGADES

36. General

a. The field army support command (FASCOM) commander is responsible for providing all combat service support to the field army. This support is divided into two major categories: armywide service and limited-area service. Transportation armywide service provided by the transportation brigade is discussed in chapter 4. Limited-area motor transport service is a mission of the support brigades. To accomplish this mission, the support brigade commander has motor transport units attached. These units, in some cases, are the same type as those attached to the transportation brigade; however, it must be clearly understood that they are provided for the support brigade's mission and are not normally allocated for use outside the brigade area. If additional motor transport is required, it is requested from the transportation brigade. The transportation service provided by the transportation brigade is on a mission basis, and requirements are submitted through movements channels for this support.

b. The support brigade is responsible for providing combat service support to the corps and to any other army units located in its area. The staff of the support brigade is similar to that of FASCOM in that it employs technical service specialists integrated within the general staff. In the staff section of the assistant chief of staff (ACofS), services, a transportation specialist is available to advise on transportation matters and to maintain coordination with the transportation brigade to insure adequate transportation support for the support brigade.

37. Motor Transport Units

Each support brigade consists of a headquarters, a car company (TOE 55-19), and four primary operating units: two direct support and two general support groups. It is in these groups that most of the transportation units are located.

a. Car Company.

- (1) There are four transportation car companies attached to the field army support command. One is attached directly to FASCOM and one to each support brigade located in the corps area. Each car company is augmented by one additional platoon (FM 55-35).
- (2) The transportation car company provides the supported activity with a taxi and light delivery service for the transportation of personnel and light items of cargo.
- (3) In the car company, vehicles are pooled. This permits the dispatch of a minimum number of vehicles to fill the overall requirement for the supported activity in contrast to the assignment of vehicles to units with recurring, although not continuous, requirements.

b. Light-Medium Truck Company.

- (1) There are a total of 18 light-medium truck companies in the FASCOM support brigades. One company is attached to each supply and service battalion of the forward support brigades and one to each supply and service battalion of the general support groups of the rear support brigade. The direct support groups in the rear support brigade have two companies in the supply and service battalion.
- (2) The light-medium truck companies provide motor transport for the movement of all classes of supply, except bulk class III, within the brigade area. The attachment of the light-medium truck company to the supply and service battalion of the general support or direct support group is not intended to limit its service to that battalion. Rather, its capability is used to assist all elements of the group to accomplish their respective missions. Requirements from

other units of the group for use of the vehicles are submitted through the group operations section to the battalion which, in turn, commits the capability of the company.

c. Transportation Medium Truck Company (Petroleum). Three medium truck companies (petroleum) are attached to the quartermaster petroleum battalion in each general support group assigned to the rear support brigade (a total of six companies). These companies are used entirely in support of the battalion's mission of distribution of bulk petroleum products.

38. Motor Transport Operations

Motor transport operations in the support brigades are directly tied to the throughput concept whereby the communications zone (COMMZ) delivers dry cargo to destinations as far forward as possible in the field army (para 26). This leaves three general types of cargo movements to be completed by FASCOM in order to deliver the cargo to its final destination—the using unit. The first is the movement of the cargo which was delivered to army service area by COMMZ transport, to forward direct and general support groups. The second is the movement of cargo from general support units to direct support units and in some instances to

using units. The third is the movement of cargo from direct support units to supported units.

a. The movement of cargo from the army service area to forward direct and general support groups is performed by elements in the motor transport group assigned to the transportation brigade. The movement of this cargo is programed by the FASCOM movements agency and is not a responsibility of the support brigade.

b. The movement of cargo delivered to general support groups by COMMZ transport to direct support units or to using units is a combination move. The general support groups use organic motor transport when available. When organic transport is unavailable or committed to capacity, requests for additional motor transport required are made to the transportation movements office located in the group's area. Movements personnel process the requirements and obtain the additional transport from the motor transport group in the transportation brigade.

c. The movement of cargo from direct support units to the user is the responsibility of the direct support group. The group has attached motor transport units to perform its mission. In situations where direct support units are unable to fulfill this requirement, support may be requested as outlined in *b* above.

CHAPTER 7

TRANSPORTATION SERVICE FOR DIVISIONS AND INDEPENDENT CORPS

39. Division Transportation Functions

a. Staff Functions.

- (1) General staff responsibilities for transportation matters in the division are divided between the G3 and G4. The G3 has general staff responsibility for transportation matters concerning tactical troop movements. The G4 has general staff responsibility for logistic and other administrative transportation, including establishment of a division traffic regulating headquarters (FM 54-2).
- (2) In the current division, transportation special staff functions have been delegated to the support command, which has in the headquarters and headquarters company an organic transportation section. This section consists of a transportation officer (major), a movements officer (captain), and two enlisted specialists. At the discretion of the support command commander, the transportation office may be responsible for all or part of the following activities:
 - (a) Advising the support command commander concerning operation of surface transportation.
 - (b) Assisting the G3 or G4, as authorized or directed by the support command commander. When division plans have been prepared, the transportation officer coordinates transportation requirements, prepares implementing plans for transportation, and exercises special staff supervision over surface transportation elements.
 - (c) Inspecting transportation activities of the division.

b. Motor Transport Operations.

- (1) To provide the division with an organic motor transport capability, a motor trans-

port company has been attached to the supply and transport battalion of the support command. This unit provides the motor transport for distribution of all classes of supply except class V. It is used to transport the division reserve supplies which are a responsibility of the supply and transport battalion. In the movement of the division, the company displaces the division headquarters and the division administrative company and supplements the transport provided to move the other elements of the division.

- (2) Employment of the motor transport company depends on the tactical and logistical situations, terrain, and support being afforded by field army transport. The establishment of a transportation section at support command headquarters provides a movements element to best use this capability. The transportation officer prepares the division movements plan under supervision of the support command commander. Priorities for the use of transport are established at general staff level and are supplied to the support command. The movements personnel of the transportation section balance the requirements against the capability and, based on the priorities and guidance of the support command commander, commit the transport.

c. Highway Regulation. Highway regulation within the division is accomplished through a division traffic headquarters to control the division road net. The support command S4 provides staff supervision to coordinate activities of the transportation and provost marshal personnel who operate the headquarters. All requests for highway convoy clearance are submitted to this headquarters (app. II).

40. Field Army Transport Support for Divisions

a. *General.* The division becomes a user of the armywide transportation system in at least two ways—

- (1) The vehicles of the transportation brigade (air and motor transport) deliver personnel and supplies to certain operating units in the division area. An example of such delivery is found in the unit distribution of ammunition to operating artillery battalions in the forward areas.
- (2) Transportation brigade motor transport vehicles and aircraft are used to provide mobility for the division in support of tactical deployments. The transportation brigade has sufficient light trucks available in each motor transport battalion (forward) to motorize a brigade (seven companies) of infantry.

b. *Transportation Movements.*

- (1) The organization for transportation movements in the field army consists of a movement control center headquarters located at field army support command (FASCOM) headquarters and transportation movements offices (TMO's) located at critical points throughout the field army. The division support command transportation section establishes contact with the TMO located nearest the division for transportation movements support.
- (2) Requests for transport support originating within the division are submitted to the division transportation officer. If the requested support is in excess of the division's capabilities, the transportation officer forwards the request to the TMO serving the division. The TMO satisfies the requirement if capability is available locally; if not, he forwards the request to the next higher TMO for action.

c. *Highway Regulation.* The corps traffic headquarters is available to clear all division moves, tactical and logistic, through the road network controlled by the corps. Requests for road clearance are forwarded through the division traffic headquarters to the corps traffic headquarters. The corps traffic headquarters is normally established at the corps support brigade headquarters. Transpor-

tation specialists on the staff of the assistant chief of staff (ACofS), services, of the support brigade form the headquarters. At the direction of the FASCOM commander, additional personnel from the highway regulating section of the transportation brigade headquarters may be attached to the traffic headquarters.

d. *Motor Transport.* One of the five motor transport battalions of the transportation brigade motor transport group is located in each corps area. These units are designed to operate on a pooled basis and, in order to meet the demands of all the units in the corps area, are committed by the FASCOM movements organization. Divisions having motor transport requirements submit them to the TMO in their respective areas. The TMO coordinates the requirements with the movement control center at FASCOM and satisfies the requirements within priorities established by the appropriate commander. In the case of separate corps operation, priorities are established by the corps commander and are implemented by the corps support command (COSCOM) commander. In a normal three-corps operation, the army commander establishes priorities and the FASCOM commander implements them through the movements organization. Priorities established by corps commanders are recognized as long as there is no conflict with those of the field army commander.

e. *Air Transport.*

- (1) Elements of the aviation group, transportation brigade, provide tactical and logistic airlift support for divisions as required. Tactical requirements for the use of Army transport aircraft are submitted to the division aviation battalion. The aviation battalion has an organic airlift capability and determines whether additional support is required. When additional support is needed, the battalion coordinates the request for aircraft support with the G3 and the corps aviation officer. Tactical attachment of transport aircraft is on a mission basis and is under control of the combat commander.
- (2) Airlift requests for logistic purposes are processed through the transportation section of the division support command to the TMO in the immediate area. Area TMO's process airlift requests in accordance with established Army procedures;

normally, these are similar to those outlined in *d* above for motor transport. Or control of all available air transport may be centralized at aviation group-movement control center level with TMO's submitting requirements to the movements control center headquarters. In this case, the movements control center headquarters processes the request and places the requirement for transport on the aviation group. The group determines and notifies the battalion which is best suited to accomplish the movement. The battalion, in turn, places the requirement on the appropriate company(ies). Close coordination between the transportation movements elements and the aviation units is essential at all levels to assure that neither cargo nor aircraft are delayed at any point in time.

41. Transportation Service for Corps Troops

a. General. Transportation service provided for corps troops is similar to that provided for divisions. However, in most cases, the method of obtaining the service required varies considerably from that of a divisional unit, as the corps unit deals directly with the support elements provided by the corps support brigade or the armywide service elements of the transportation brigade. Corps units, such as corps artillery, corps engineers, or corps chemical elements, require the same transportation services as divisional units, including movements management, highway regulation, and motor and air transport.

b. Movements Management. Corps units are provided with movements-management service by TMO's located within the corps area. These movements offices are part of the movement control center of the transportation brigade and are established to provide customer service in the field army area. Corps units requiring nonprogramed transport support by air or surface submit their requests to the TMO in their area for action. Local TMO's assist in the computation of requirements and forward requests to the movement control center at the FASCOM for action if they cannot be satisfied locally.

c. Traffic Regulation. A traffic headquarters to coordinate the use of highways is normally established at the corps support brigade headquarters. This traffic headquarters serves corps units by pro-

viding a regulation unit for the corps highway net. All requests for highway convoy clearances or for movement of outsize or overweight vehicles are submitted to this headquarters for approval and scheduling (app. II).

d. Motor and Air Transport Support. The armywide transportation services of the transportation brigade provide air and motor transport support for nondivisional corps units. These services are available through the local TMO. Commanders of nondivisional corps units requiring nonprogramed logistic air or motor transport support should submit their requirements to the TMO in their area. Requests for tactical air transport should be submitted to the corps aviation officer for approval by the corps G3 and for forwarding to army.

42. Transportation Service for Independent Corps

a. General. When a corps is detached from the field army for an independent mission or a corps-size element is the extent of the forces in a particular area, a corps support command (COSCOM) is formed. The organization of the corps support brigade readily lends itself to the formation of the COSCOM and is used as a nucleus for this organization. The support brigade headquarters is patterned after the FASCOM headquarters to provide a command organization for the COSCOM. Armywide type services are attached, as required, to make the organization self-sustaining. The corps support brigade ACofS, services, becomes the COSCOM ACofS, services, and transportation specialists on his staff provide technical supervision over attached elements of the armywide type transportation services.

b. Forming the COSCOM. The COSCOM is formed at the direction of the theater commander or other appropriate commander. Generally, the order establishing the independent corps simultaneously establishes the COSCOM. The corps support brigade is assigned to the corps; elements of what would normally be the armywide transportation services of the transportation brigade are attached to the COSCOM. The COSCOM commander assumes the same relationship to the corps commander as the FASCOM commander has to the field army commander.

c. Attachment of Armywide Transportation Units. Attachments of additional transportation capability to the COSCOM are based on the as-

signed mission of the separate or independent corps; normally motor transport units, aviation units, movements management personnel, and highway regulating personnel are attached. The aviation and motor transport units are under the technical supervision of the staff of the COSCOM ACoS, services, the transportation movements and highway regulation personnel are directly under the ACoS, services.

d. Staff Coordination. Coordination between elements of the corps staff and the COSCOM staff parallel the relationship between the field army staff and the FASCOM staff. The corps staff concern

themselves with the tactical aspect of planning and coordination; the COSCOM staff is concerned with the logistics problems created by the particular action. The corps G3 and G4 coordinate closely with the COSCOM ACoS, services, in all matters pertaining to movement of the corps. The COSCOM ACoS, services, establishes a movement control center at that headquarters and balances the capability of organic and attached transport against requirements created by the corps mission. Highway regulation is provided by a traffic headquarters located at COSCOM headquarters under the supervision of the ACoS, services.

APPENDIX I

REFERENCES

1. Field Manuals

FM 1-5	Army Aviation Organizations and Employment
FM 1-10	Army Aviation Organizational Aircraft Maintenance and Supply
FM 1-100	Army Aviation
FM 8-10	Medical Service, Theater of Operations
FM 8-16	Medical Service, Field Army
FM 9-30	Maintenance Battalion Division Support Command
FM 10-8	Air Delivery of Supplies and Equipment in the Field Army
FM 10-50	Supply and Transport Battalion, Division Support Command
FM 11-20	Signal Operations, Theater of Operations
FM 11-21	Tactical Signal Communications Systems, Army, Corps and Division
FM 19-2	Military Police Support in the Field Army
FM 21-5	Military Training
FM 27-10	The Law of Land Warfare
FM 29-3	Direct Support Maintenance in the Field Army
FM 30-5	Combat Intelligence
FM 30-16	Technical Intelligence
FM 38-1	Logistics Supply Management
FM 41-5	Joint Manual of Civil Affairs/Military Government
FM 41-10	Civil Affairs Operations
FM 54-1	The Logistical Command
FM 54-2	Division Logistics and the Support Command
FM 54-3	The Field Army Support Command
FM 54-4	The Support Brigade
FM 55-4	Transportation Movements in Theater of Operations
FM 55-6	Transportation Services in Theater of Operations
FM 55-10	Transportation Movements Services, Field Army
FM 55-15	Transportation Reference Data
FM 55-35	Motor Transport Operations and Motor Transport Units
FM 55-41	Transportation Aircraft Maintenance Units
FM 55-45	Aircraft Maintenance Services and Units in the Field Army
FM 55-46	Transportation Air Transport Services and Units in the Field Army
FM 55-56	Transportation Terminal Transfer Company
FM 61-100	The Division
FM 100-5	Field Service Regulations; Operations
FM 100-10	Field Service Regulations; Administrative
FM 100-15	Field Service Regulations; Larger Units
FM 101-5	Staff Officers' Field Manual; Staff Organization and Procedure
FM 101-10,	Staff Officers' Field Manual; Organizational, Technical and Logistical Data. Part
Part I	I—Unclassified Data
FM 101-10,	Staff Officers' Field Manual; Organizational, Technical, and Logistical Data.
Part II	Part II—Extracts of Tables of Organization and Equipment

2. Technical Manuals

TM 38-750 Army Equipment Record Procedures
TM 38-750-1 Maintenance Management, Field Command Procedures
TM 55-series As appropriate to transportation equipment

3. Army Regulations

AR 55-10 Military Standard Transportation and Movement Procedure (MILSTAMP)
AR 55-22 Allocation of Transportation Space
AR 55-166 Utilization of Cargo Transporters in CONEX Service
AR 220-1 Unit Readiness
AR 320-5 Dictionary of United States Army Terms
AR 320-50 Authorized Abbreviations and Brevity Codes
AR 380-5 Safeguarding Defense Information
AR 711-16 DSO/Installation Stock Control and Supply Procedures (Army Field Stock Control System)

AR 725-50 Requisitioning, Receipt, and Issue System
AR 735-35 Supply Procedures for TOE Units, Organizations and Non-TOE Activities
AR 750-1 Maintenance Concepts
AR 750-5 Organizational, Policies, and Responsibilities for Maintenance Operation
AR 750-10 Materiel Readiness (Serviceability of Unit Equipment)
AR 750-17 Maintenance of Reusable Steel Shipping Boxes
AR 750-45 Materiel Readiness of Selected Equipment (Reports Control Symbol CSGLD-1042)

AR 750-1500-8 Use of Serviceable Parts from Unserviceable Aircraft or Aircraft Components

4. DA Pamphlets

Pam 108-1 Index of Army Motion Pictures, Filmstrips, Slides, Tapes, and Phono-Recordings
Pam 310-series Military Publications Indexes
Pam 750-1 Preventive Maintenance Guide for Commanders

5. Technical Bulletins

TB AVN 23-16 Test Flights and Maintenance Operational Checks for Army Aircraft

6. Tables of Organization and Equipment

TOE 1-252 Headquarters and Headquarters Company, Aviation Group
TOE 1-256 Headquarters and Headquarters Company, Aviation Battalion
TOE 1-257 Aviation Fixed Wing Company
TOE 1-258 Aviation Medical Helicopter Company
TOE 54-12 Headquarters and Headquarters Company, FASCOM
TOE 54-22 Headquarters and Headquarters Company, Support Brigade
TOE 55-6 Headquarters and Headquarters Detachment, Transportation Movement Control Center

TOE 55-12 Headquarters and Headquarters Detachment, Motor Transport Group
TOE 55-16 Headquarters and Headquarters Detachment, Transportation Motor Transport Battalion

TOE 55-17 Transportation Light Truck Company
TOE 55-18 Transportation Medium Truck Company
TOE 55-19 Transportation Car Company, Army, Logistical Command, or Airborne Corps
TOE 55-28 Transportation Heavy Truck Company
TOE 55-62 Headquarters and Headquarters Company, Transportation Brigade
TOE 55-67 Transportation Light-Medium Truck Company
TOE 55-118 Transportation Terminal Transfer Company
TOE 55-500 Transportation Service Organization

APPENDIX II

HIGHWAY REGULATION AND THE HIGHWAY TRAFFIC HEADQUARTERS

1. General

Highway traffic regulation is the coordination of the actual use of a road net by vehicles, personnel, and animals to meet military operational requirements. It includes the planning required to insure that this coordination is effected. Highway traffic regulation is accomplished by establishing traffic headquarters at division and higher levels. The extent of regulation exercised by a traffic headquarters depends on the amount of movement expected and the capacity of the road network. If little movement is anticipated, organizational control may suffice; if heavy movement is foreseen, the traffic headquarters must prepare movement instructions. Types of movements normally scheduled by traffic headquarters include, but are not limited to, convoys, oversize vehicles, overweight vehicles, vehicles moving by infiltration, and road movement of troops on foot.

2. Terminology

The following terms are frequently used in highway regulation. Certain designated terms have been specifically defined in NATO standardization agreements (STANAG's) and in AR 320-5.

a. Control Point—A position along a route at which men are stationed to give and receive information and instructions for the regulation of traffic (AR 320-5).

b. Open Route—A route for the use of which no movement credit (*g* below) is required (STANAG 2151).

c. Controlled Route—A route the use of which is subject to traffic or movement restrictions (STANAG 2041).

- (1) *Supervised route*—A roadway over which control is exercised by a traffic control authority by means of traffic control posts, traffic patrols, or both. A movement credit is required for its use by a column of 10

or more vehicles or by any vehicle of exceptional size or weight.

- (2) *Reserved route*—A controlled route the use of which is—

- (a) Allocated exclusively to a particular authority or formation, or
(b) Intended to meet a particular requirement; for example, a route reserved for evacuation.

- (3) *Dispatch route*—A roadway over which full control, both as to priorities of use and the regulation of movement of traffic in time and space, is exercised. A movement credit is required for its use by any independent vehicle or group of vehicles regardless of number or type (STANAG 2041).

d. Critical Point—Any point along a route where interference with a movement may occur (AR 320-5).

e. Military Road Network—Includes all routes designated in peacetime by the host nations to meet anticipated military movements and transport movements, both allied and national (STANAG 2041).

f. Military Road Maneuver Network—The road system required by a commander for the conduct of a specific operation and for the required logistical support of that operation (STANAG 2041).

g. Movement Credit—The time allowed to one or more vehicles to move over a supervised, dispatch, or reserved route (STANAG 2154).

h. Movement Number—A number which is allocated at the same time as the movement credit by the authority organizing the movement. This number will identify the column during the whole of the movement (STANAG 2154).

i. Traffic Control—On-the-spot direction of traffic at specific locations such as crossroads. This is primarily a military police function.

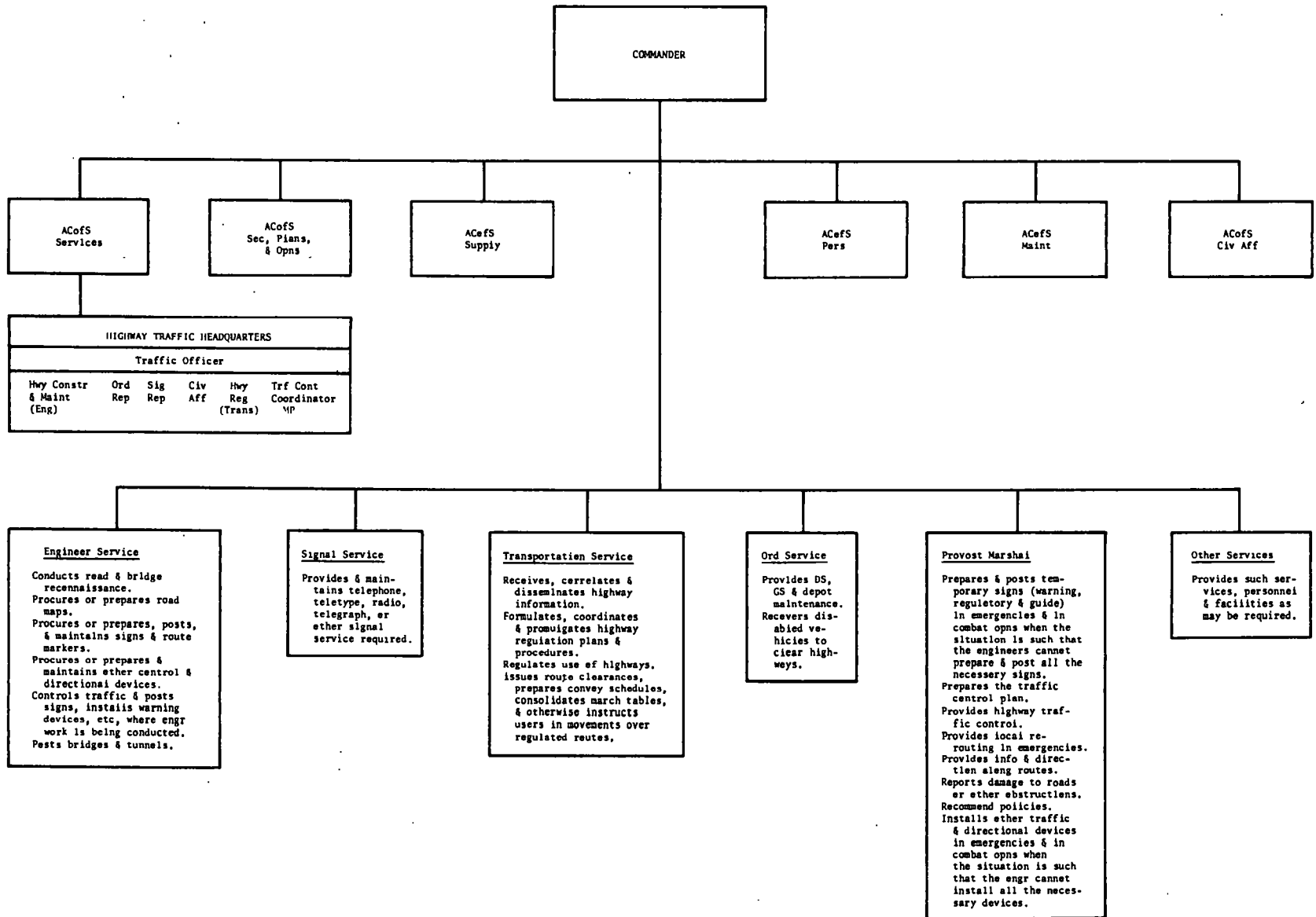

Figure 5. Organization of a traffic headquarters.

3. Organization of the Highway Traffic Headquarters

a. All matters pertaining to highway traffic regulation are centralized in the highway traffic headquarters which is established under control of the assistant chief of staff, G4, or the assistant chief of staff, services, in a functionalized staff. A transportation specialist (highway traffic officer) in the staff section is normally charged with operating the traffic headquarters. Other transportation personnel are assigned to assist the highway traffic officer, and they may be augmented by highway regulating teams from TOE 55-500 or by personnel from the highway regulating section of the transportation brigade.

b. The traffic headquarters depends upon information, recommendations, and services from other agencies. Information and recommended action pertaining to personnel, intelligence, tactical and logistic plans, and civil affairs are supplied by the appropriate general staff section or directorate. The overall plan for highway regulation is formulated by the traffic headquarters and coordinated with other staff agencies as shown in figure 5. Military police personnel are assigned to the traffic headquarters as required. Representatives for civil affairs, engineer, ordnance, and signal services normally are not assigned to the traffic headquarters but are available when required for coordination in matters that are the primary responsibility of their respective offices.

c. The traffic headquarters conducts its operations in the name of the commander. Coordination between traffic headquarters therefore generally parallels command channels, but, to reduce reaction time, direct communication between adjacent headquarters normally is authorized.

4. Functions of the Highway Traffic Headquarters

The functions required of a traffic headquarters may vary among commands. They generally include, but are not limited to, the following:

a. Maintaining a situation map of the military maneuver road network (or military road network, as appropriate) showing current data on obstructions, detours, defiles, capacities, and surface conditions.

b. Implementing established priorities for highway movement in accordance with the commander's instruction.

c. Receiving requests (proposed itineraries) for highway routing and for schedules of movements from units within its area of jurisdiction.

d. Consolidating itineraries and road movement tables (STANAG 2041), scheduling highway movements, and issuing movement credits as necessary.

e. Establishing and issuing traffic circulation map.

f. Making necessary changes in routings, schedules, and priorities as dictated by the situation and informing unit or convoy commanders of the action (through command channels when possible, otherwise through highway regulating points or traffic control posts).

g. Receiving, recording, and disseminating (as required) information from other traffic headquarters concerning highway movements into its area of jurisdiction.

h. Coordinating movements terminating outside its area of jurisdiction with other traffic headquarters.

5. Highway Regulation Planning

a. General.

- (1) A highway regulation plan is a staff plan, which may be oral or written, concerning the capabilities of the existing road net to handle the traffic that must move thereon. Information derived from this plan is disseminated to the user by a traffic circulation plan or order and usually appears in the form of an overlay.
- (2) The highway regulation plan is initiated well in advance of actual operations and is prepared to conform with the size of the command; the road network; the logistical situation; and the mission, composition, and disposition of tactical units. Planning must be fully coordinated with other staff agencies and among all echelons of commands concerned.
- (3) A highway regulation plan must be adaptable to changes in the situation. If traffic is light, this may present little difficulty; however, when traffic is heavy and tightly scheduled, each adjustment may necessitate additional adjustments. If the plan is extensive, numerous calculations are involved and the plan tends to lose flexibility; if limited, the necessary control may

be lacking. A balance must be found that provides the degree of control required by the commander, while permitting all possible flexibility and responsiveness to change.

b. *Planning Information.* The information required for highway regulation planning includes—

- (1) Information regarding operational plans of the command; policies, priorities, and restrictions imposed by higher headquarters; and plans for logistical support of the command.
- (2) General route information—surface or pavement type, alinement, surface and width of shoulders, location and characteristics of bypasses or detours around limiting physical features and potential hazards, highway network distances, driving times, and highway capabilities. Alternate routes are considered as well as critical points along all routes where ambush or other enemy action might be encountered.
- (3) Traffic information—traffic density and anticipated volume by vehicle type; variations in the traffic flow over sections of routes during specific periods; the need for traffic patrols; and the location of sensitive areas such as potential bottlenecks, intersections requiring control, or railroad crossings requiring guards.
- (4) Terminals and other facilities—location and characteristics of supply points, depots, service stations, tractor-trailer relay points, turnarounds, off-road parking areas, bivouac areas, and evacuation or hospital facilities, with consideration for access from major routes and the capabilities for receiving, loading, unloading, and providing maintenance and service for motor transport.
- (5) Availability of communication equipment.

c. *Sources of Information.* The information required for planning is generally derived from the following sources:

- (1) The assigned mission, which may be a separate logistic mission or an extension of the tactical mission.
- (2) Current estimates, the administrative order, and administrative plan(s).

- (3) Reconnaissance as thorough as the situation and time permit. Preliminary information concerning the road network is generally obtained from maps, aerial photographs, local traffic authorities, intelligence reports, and transportation intelligence studies. This information is verified and supplemented by ground reconnaissance and, when practicable, by aerial reconnaissance. Ground reconnaissance parties may be composed of engineer and/or transportation personnel. The route reconnaissance overlay, furnished by the engineer officer, provides detailed information regarding the characteristics of the road net. (For an example of an overlay, see FM 5-36).

d. *Contents of the Traffic Circulation Plan.* The traffic circulation plan (fig. 6) reflects the road net that is planned to be used and maintained and shows how it is to be used. It may be as brief or as detailed as required. The following information is normally included:

- (1) The most restrictive route features and route designations.
- (2) Direction of movement.
- (3) Location of boundaries, units, highway regulating points, traffic control points, and principal supply points and depots.
- (4) Major geographic features and light line(s), if applicable.

e. *Standing Operating Procedures (SOP's).* Detailed directives concerning procedures to be used in highway traffic regulation are contained in the command SOP and the highway traffic headquarters internal SOP.

6. Management of the Plan

a. Management includes all measures taken to insure effective implementation of the highway regulation plan. The transmission of clear, concise instructions to the commanders of all road movements and the distribution of pertinent information to all control personnel must be timely and thorough. The mechanics of this phase can be simplified by inclusion of highway traffic regulation procedures in the command SOP and development of an internal SOP for traffic headquarters.

b. The information included in SOP's should be routine in nature and not subject to frequent

Annex A (Traffic Circulation and Control) to ADMINO 14
 Reference: Map, UNITED STATES, 1;100,000, UPTON Sheet
 Acknowledge

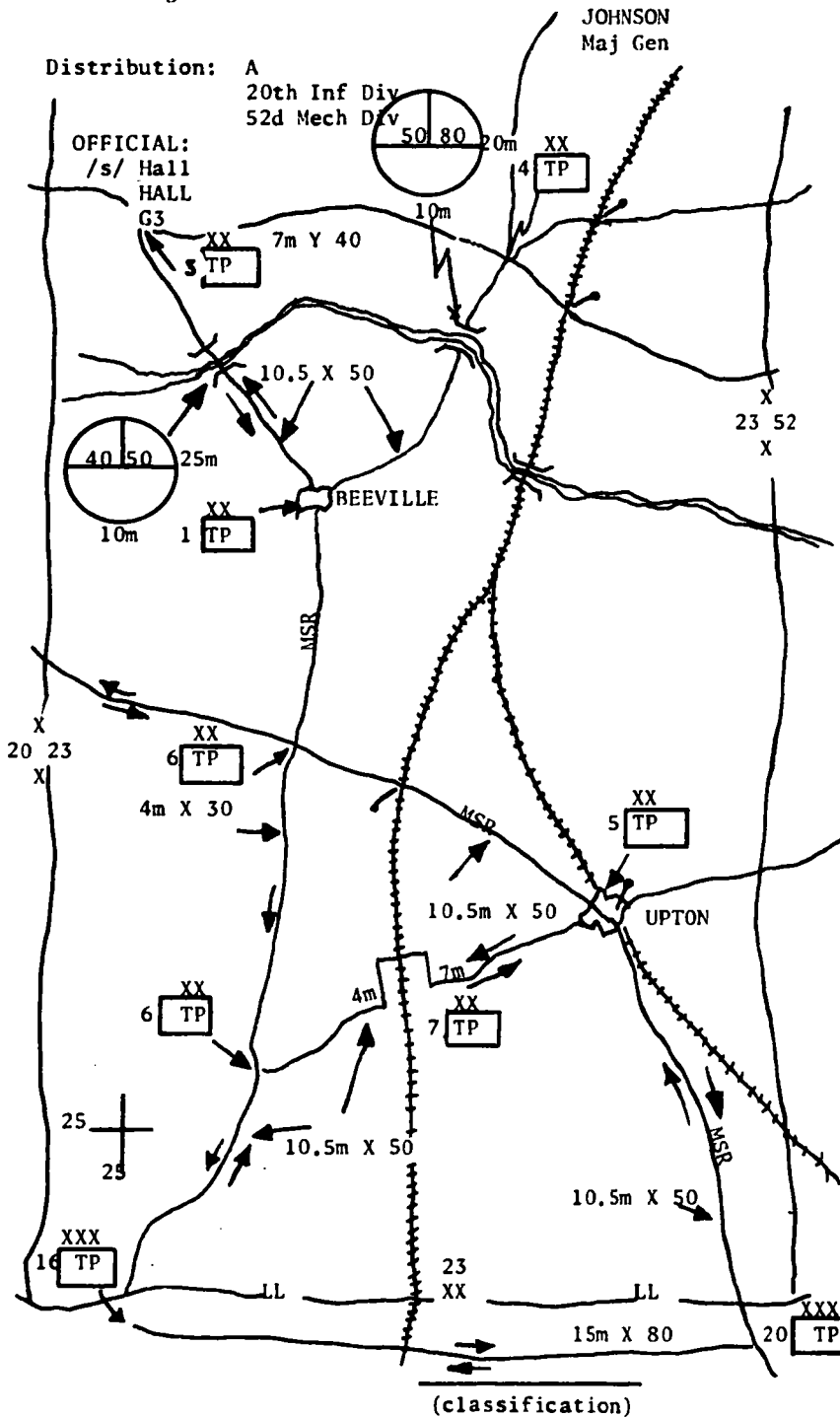
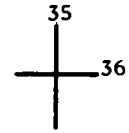

Figure 6. Sample traffic circulation plan.

change. Concurrence of all interested staff agencies (for example, provost marshal and engineer) must be obtained before publication. Instructions and information regarding the following matters may be appropriate for publication in standing operating procedures:

- (1) Rate of march and maximum permissible speed.
- (2) Frequency and duration of halts.
- (3) March discipline.
- (4) Special rules of the road.
- (5) Methods for handling stragglers and disabled vehicles.
- (6) Procedures for obtaining road clearance or movement credits.
- (7) Reports and reporting procedures.
- (8) Gaps between vehicles and between serials.
- (9) Controls required; for example, use of guides, flags, and markings.
- (10) Identification of highway regulating and traffic control personnel by armbands or other means.

7. Traffic Routing

a. Routing is the planning of highway movements over designated routes. Three fundamentals governing the planning of movements over designated routes are balance, separation, and distribution.

- (1) Balance is the matching of vehicle characteristics with characteristics and limitations of available routes; for example, routing heavy, cumbersome, or outsized equipment over a route with grades and curves within the capabilities of the equipment and with bridges of adequate capacity and width.
- (2) Separation is the allocation of nonconflicting routes to concurrent movements.
- (3) Distribution is the allocation of as many routes as possible for the movement of traffic to reduce traffic conflict, to prevent deterioration of road surfaces from the concentration of heavy traffic, to effect vehicle dispersion, and to decrease the time required to complete the movement.

b. The following principles should govern the routing of traffic:

- (1) Route traffic from its origin by way of predetermined intermediate locations to destination.

- (2) Assign highest priority traffic to routes that provide the minimum time distance.
- (3) Consider the capabilities of roads and bridges for sustained operations when assigning movements to routes.
- (4) Separate motor movements from foot and animal movements and slow motor movements from fast ones by assigning different times for each in accordance with their respective march capabilities. When necessary, arrange for assignment of civilian traffic to separate routes to insure freedom of movement for essential military traffic.

8. Traffic Scheduling

a. Traffic scheduling is the coordination of times for road movements along routes. Scheduling is necessary in order to—

- (1) Give priority to units in accordance with the commander's directives and, when scheduling the movement of several units, to units moving to more distant positions.
- (2) Minimize delays, conflicts, and congestion by insuring that traffic flow never exceeds the capacity of the most limiting feature (severe bottleneck) of the route and by reducing peak traffic by spreading the flow.
- (3) Provide detailed regulation of special or high-priority individual movements.
- (4) When air superiority is not established, promote security and passive defense by scheduling movements during hours of darkness.
- (5) Restrict traffic to road capabilities to permit necessary highway maintenance.
- (6) Maintain cognizance of all convoys so that at any time they can be rerouted, diverted, used to meet emergencies, or held to permit the passage of priority movements.

b. In planning a large-scale road movement, many of the schedule computations become complicated and repetitious. These computations can be simplified by—

- (1) Preparation and use of conversion tables for changing U.S. common to metric distances, number of vehicles to time length, and distance to time.
- (2) Standardizing as many variables as possible. For example, if all wheeled vehicles

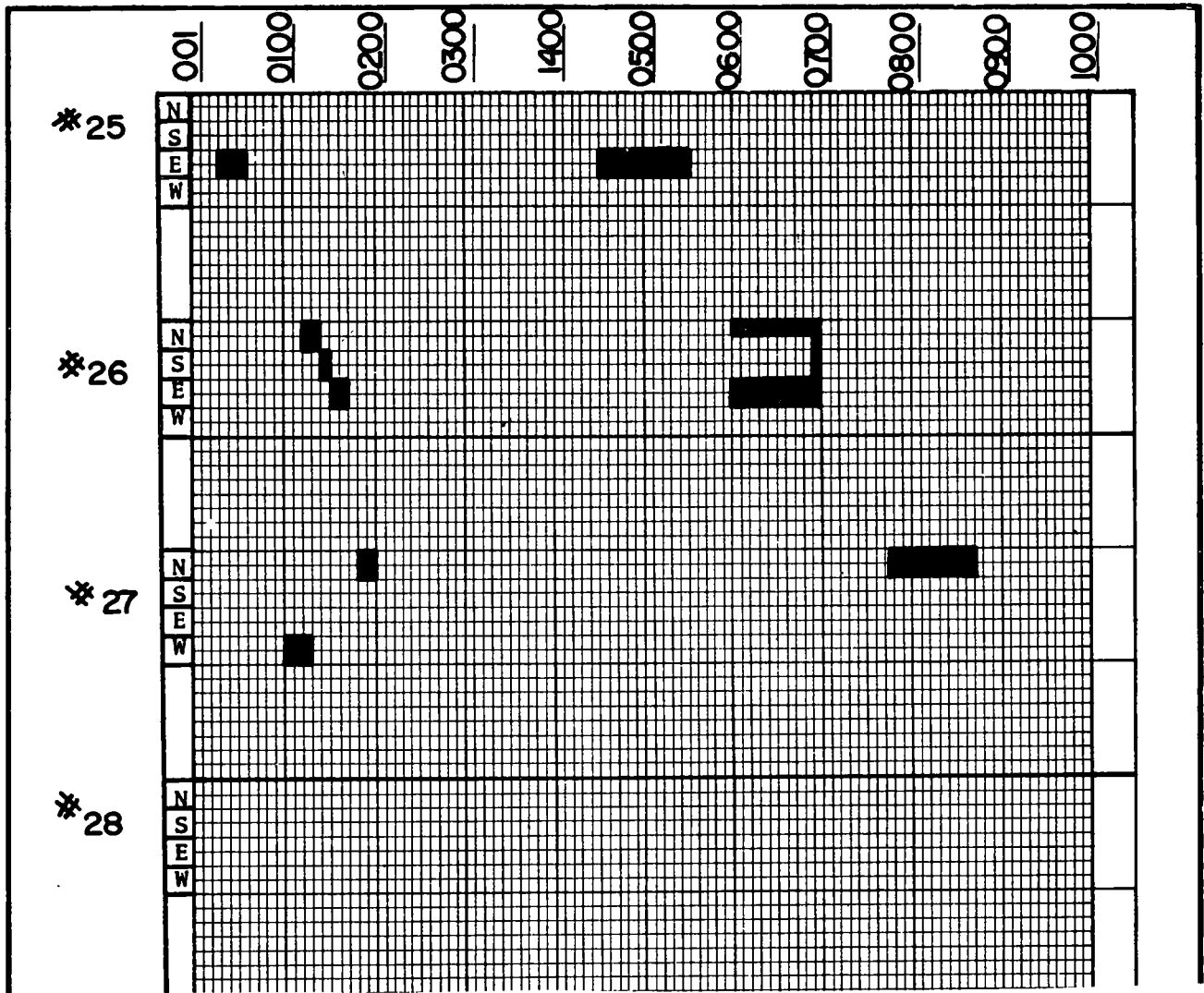

Example: Critical points 25, 26, and 27 are occupied at various times from 0001 to 0200 by miscellaneous small convoys. A large convoy traveling east will occupy critical point 25 from 0430 until 0530. It will arrive at critical point 26 at 0600 where it will turn north and occupy the intersection until 0700. Between 0745 and 0845 it will occupy critical point 27.

Figure 7. Critical time and point graph.

that are not overweight or oversize can be directed to use the same rate of march on a certain class of road, scheduling is simplified and the route is used efficiently.

c. Road movements may be scheduled by the following methods:

(1) *Infiltration schedule.* An infiltration schedule is a vehicle dispatch rate assigned to a unit for a specified period. Vehicles or small groups of vehicles, after dispatch, proceed independently to their destinations over a prescribed route. By assigning appropriate rates of dispatch to different units using the same route, average traffic flow is held within desired limits. For example, two vehicles may be dispatched every 5 minutes the first hour and every 10 minutes the second hour.

(2) *Location schedule.*

(a) A location schedule minimizes congestion and prevents clogging of the traffic stream by assigning nonconflicting times for arrival and departure to different units at a particular location. The location may be a city boundary, detour, intersection, or other critical point. It may also be applied by assigning specific time for movement in one direction; for example, at a particular intersection, unit A may be scheduled to arrive at 1000 and clear at 1015; unit B to arrive at 1020 and clear at 1030, etc. Or northbound movements might be scheduled to proceed through a defile every even hour and southbound movements every odd hour. Location scheduling may be simplified and graphically portrayed by use of the critical time and point graph (fig. 7).

(b) The critical time and point graph offers the traffic headquarters a more flexible and comprehensive system for scheduling movements and checking requests for scheduling than does the march graph (para 10). It consists of a separate graphic chart for each selected critical point. These charts are divided into four sections representing the directions of column movement and into time segments to represent a 24-hour period.

(c) To use the critical time and point graph, the period of occupation of each numbered critical point is determined from the schedules of units using the road net during the period shown. As this information is plotted, conflicts become apparent. Separate columns may be identified by symbols or colors instead of shading as shown in the example. In order to obtain a complete graphic presentation of movements, the critical time and point graph can best be used in conjunction with the traffic circulation plan.

(3) *Column schedule.* The column schedule indicates the arrival and clearance times for individual movements at specific points along a prescribed route of march. This schedule is used for the movement and is an aid to the unit commander in exercising unit control. Movement instructions often take the form of march graphs or road movement tables approved by the appropriate traffic headquarters.

(4) *Route schedule.* The route schedule is used to apportion time to individual movements proceeding along or intersecting given routes. Certain routes may be designated as controlled routes, and a march graph may be prepared for each. The routes selected may be main supply routes, routes that will carry the greatest volume of traffic as indicated by traffic analysis, or routes selected on the basis of need for coordination. For example, in planning for a special operation, the routes described in all proposed itineraries submitted for approval for movement on a given day may be plotted in a single overlay. The route(s) over which the greatest number of convoys move should then be selected as the dispatch route(s). This method graphically portrays the progress of each convoy (for example, a change in the rate of march is readily apparent). The route schedule is limited in scope as, by itself, it provides no control over movements to and from the dispatch route.

d. The following are axioms for guidance in scheduling highway movements:

(1) Intraarea movements are scheduled and a

movement number assigned to the unit by the traffic headquarters of the command having area jurisdiction (STANAG 2154).

- (2) Interarea movements are coordinated between areas concerned. The traffic headquarters in the area where the movement originates assigns the movement number. Where interarea movements conflict and cannot be resolved by the traffic headquarters concerned, the commander having overall jurisdiction is advised through the appropriate general staff section and is requested to determine the priority of movements.
- (3) A round trip scheduled for completion within 24 hours is treated as a single movement. When more than 24 hours are required to complete a round trip, the return trip may be treated as a separate movement requiring a new movement number.
- (4) A movement in one direction only, regardless of the number of days involved, is treated as a single movement and retains the same movement number to destination.
- (5) March units within a column may be identified by adding a letter behind the movement number.
- (6) Approved schedules and assigned movement numbers are furnished the provost marshal so that he may provide necessary traffic control within his capabilities.

9. Procedures

a. General. Whereas the foregoing paragraphs of this appendix have been primarily concerned with the interior workings of the traffic headquarters, the following procedures pertain primarily to other agencies:

b. Request for Convoy Clearance.

- (1) Before beginning a road movement over a route requiring a movement credit, the unit must submit a request for clearance through command channels to the traffic headquarters within whose area the movement originates.
- (2) DD Form 1265 (Request for Convoy Clearance) is a dual-purpose document serving as either a request or an authorization for movement, or both. It is used

by the requesting agency desiring to initiate a movement via highway and by the traffic headquarters to grant clearance and to issue instructions for the road movement. Information to complete this form is supplied by the unit requesting the movement. Depending on the urgency of the requirement, the information contained in the form may be transmitted orally, electrically, or in writing.

c. Granting the Movement Credit.

- (1) After receipt of the request, the traffic headquarters if possible, schedules the movement at the time and over the route requested by the unit. When the move cannot be scheduled at the requested time or on the requested route, the requester is immediately notified and an alternate time and/or route(s) are arranged.
- (2) After final coordination and approval, the traffic headquarters issues the necessary movement credit and movement number for the convoy plus any additional required information. This authorization is returned to the requesting agency through the same channels used in the request.

d. Issuing Priorities. Priorities are issued on the basis of urgency or critical need. Generally, when conflicts occur between movements having the same priority, forward-moving traffic has priority over traffic moving to the rear; forward-moving loaded vehicles have priority over empty vehicles moving in any direction. Priorities are established on the basis of the commander's requirements to meet the military situation and can be expected to change from time to time.

e. Emergency Operations. Changes in the tactical situation, damage to roads, or traffic congestion may require adjustments of traffic routing and scheduling.

- (1) If a breakdown or serious interruption of the traffic plan can be anticipated, alternate plans should be prepared to meet the emergency. These plans may involve re-routing, rescheduling, and relocation of control and regulation personnel.
- (2) Traffic emergencies that cannot be anticipated require prompt solution in the field. Military police, in cooperation with highway regulating personnel assist column

commanders in taking immediate action. These field agencies (highway regulating points, traffic control posts, military police motor patrols, and highway regulating point patrols) effect local emergency routing, giving due consideration to established highway routes and schedules, and report such routing to the traffic headquarters and to highway regulating points in the immediate area. Extensive rerouting is accomplished only on order of the traffic headquarters.

- (3) On receipt of advice from the field, progressive adjustments of traffic plans can be made by the traffic headquarters. Changes in the plan are communicated to the field regulating and control elements and to other affected agencies as soon as possible so that the modified plan can be implemented locally.

f. Control and Communications. The effectiveness of highway regulation depends to a major extent on the organization of staff and field personnel and the communications available for coordination and for transmission of instructions, orders, and reports.

- (1) The organization of personnel for highway regulation is based on 24-hour operation of the highway regulating point. These points are located at intervals along the route(s) so that progress of vehicles can be followed and movement schedules adjusted as required. Locations should be selected with care. Each highway regulating point should be located where a definite requirement for control can be anticipated. Truck terminals, transfer points, crossroads, or key routes to or from port or depot complexes may be advantageous locations. It may be necessary at certain selected points to provide off-road parking for convoys in order to delay the onward movement of low-priority convoys while those of higher priority are allowed to pass. These off-road parking areas should permit dispersion and provide concealment from aerial observation. The teams to operate highway regulating points are provided in TOEs 55-500 and 55-62. They are organized and equipped to—

- (a) Report on convoys and other elements

arriving at and clearing the point so that progress may be reported and their rates of advance adjusted as required.

- (b) Receive, correlate, and disseminate traffic and operational information and make reports on current highway conditions and changes as they occur.
 - (c) Transmit orders from higher headquarters to passing units or organizations.
 - (d) Make diversions and effect changes in priorities of traffic as directed.
- (2) An adequate system of communications must connect the traffic headquarters with highway regulating points and traffic control posts. To insure effective coordination of supervision and control, all control personnel, including column commanders, must be kept abreast of traffic conditions and changes affecting the operation. Organic communications equipment, the operations communication net, the area communications system, and liaison are combined for effective communications under all conditions. Army aircraft, when available, may be effectively utilized for both communications and control.

10. Preparation of a March Graph

A march graph is used to portray the movement of a vehicle or column(s) over a controlled road or road net in order to avoid conflicts in schedules and routings. An example of the procedures used to prepare a march graph follows:

a. Scheduling the Head of the Column (fig. 8). The first movement to be plotted on this graph is to start at Roland at 0400. It will proceed to Dundalk at a rate of march of 20 miles (32 km) in the hour. The distance to be traveled (100 miles (160 km)) can be determined from the strip map and the mileage scale at the left of the chart. The time required to move from Roland to the destination (time distance) at the scheduled rate of march is 5 hours. The point at which the lower end of the diagonal line begins on the graph (0 miles, 0400 hours) indicates the start point and the starting time of the convoy. The point at which the upper end of the diagonal line ends on the graph (100 miles, 0900 hours) indicates the destination and time of arrival of the head of the column at that point. The diagonal line between these two points represents the scheduled progress of the head of the

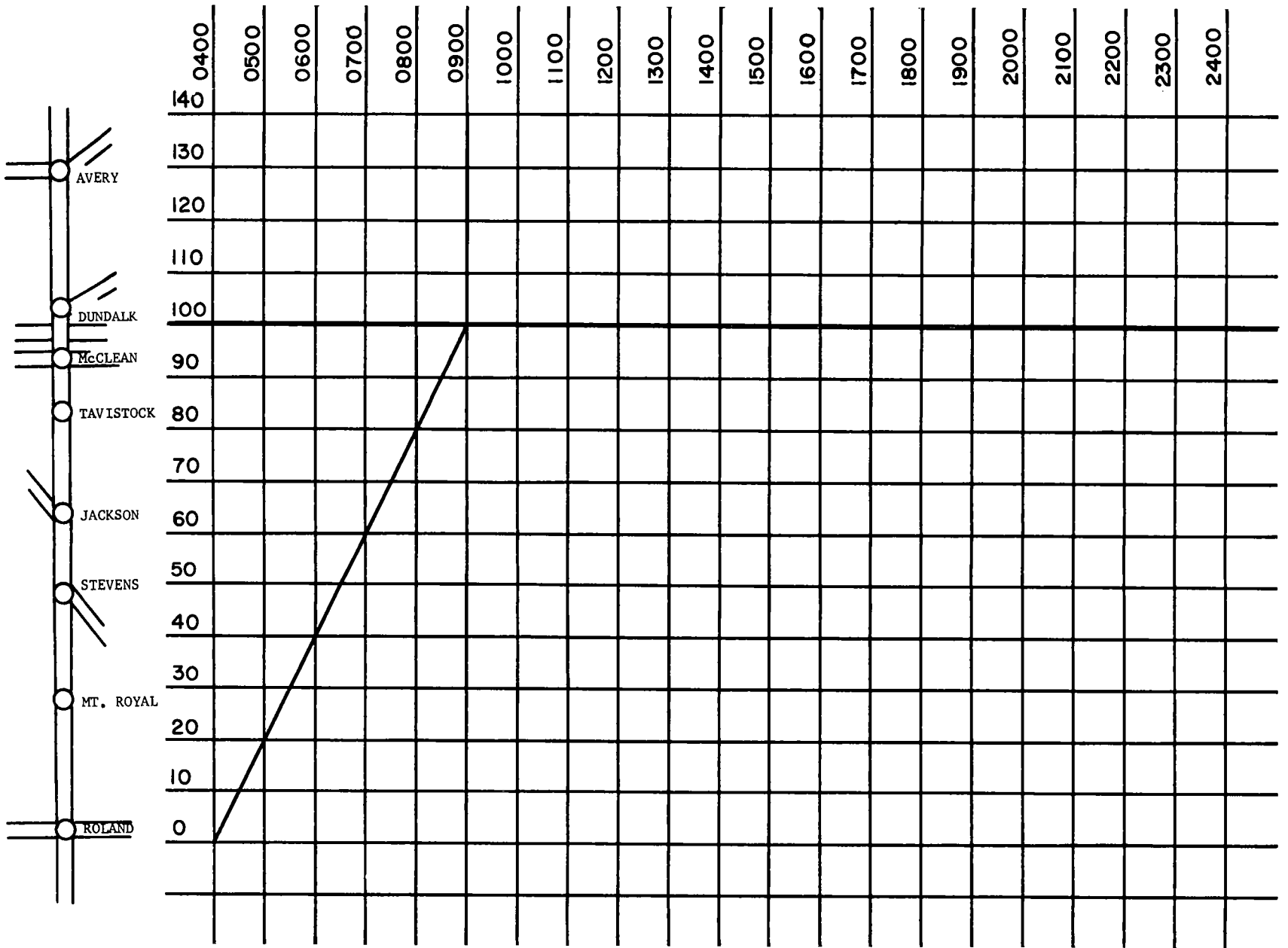

Figure 8. Plotting the head of the column.

column as it travels along the route of march (indicated by the strip map paralleling the distance scale).

b. *Scheduling the Tail of the Column* (fig. 9). Unless the march column or element is very short, both the head and tail of the column should be plotted on the graph. This is accomplished by determining the time length of the column (the amount of time it takes the column to pass any given point on the route of march), computing the time the tail will depart from the start point and its time of arrival at destination. A diagonal line between these two points (parallel to the line representing the head of the column) is drawn on the graph. These two diagonal lines (representing head and tail) may then be joined at the origin and destination to form a block representing movement of that column over the road. In the example shown, the time length of the column is 1 hour. Thus, the tail will clear Roland at 0500 and will arrive at destination at Dundalk at 1000. Figure 9 also illustrates some of the planning and operational data available through analysis of the graph.

c. *Scheduling Several Columns over the Same Route*. Road movement graphs provide the means for scheduling several columns or serials over the same route. A highway regulation officer, or the commander of an organization which is moving in several elements (serials, march units, etc.), can prepare a graph for a given period or a given group of movements. Then through information received from highway regulation personnel, traffic control personnel, convoy commanders, and other control personnel on the ground, he can maintain an accurate record on the graph as the various elements proceed along the route. Pencil shadowing, colored pencils, crayons, ink, or tape may be used to designate various elements and to indicate schedules, priorities, actual progress, etc. Changes and adjustments in the operation may be made on the graph as the various columns progress along the route of march. Figure 10 shows a road movement graph prepared for a particular group of movements. If these movements were to proceed as scheduled, they would not interfere with each other and there would be no requirement for adjusting any schedules or for changing the graph. However, situations may arise at any time during an operation which might necessitate adjusting schedules and require replotting on the graph. Figure 11 shows the graph for the movements as it might have

been completed after certain operational changes occurred. The assumed changes reflected in the graph in figure 11 are listed below.

- (1) *Column A*. Column A, scheduled to move from Roland to Dundalk at a rate of march of 20 miles (32 km) in the hour, completed its movement as scheduled.
- (2) *Column B*. Column B consisted of three serials. It was originally scheduled to move from Mt. Royal to Tavistock at a rate of march of 15 miles (24 km) in the hour. However, it received a change in orders directing that it continue without delay to Avery, the noon meal to be fed upon arrival at destination. The change was plotted on the graph, the column commander was informed, and the move was completed according to its new orders.
- (3) *Crossroad traffic*. On the original road movement graph (fig. 10), information was plotted concerning a laterally moving column which would cross the north-south route at a crossroad 6 miles (9.5 km) north of McClean and block it from 1330 to 1400 hours. This move was not identified as a serial but was shown on the graph as a line blocking the north-south route during the state period. When column B was rescheduled to its new destination (fig. 11), it was determined that there would be a conflict between the third serial of column B and the lateral movement. Since it was not considered feasible to break up the formation of column B and a check of priorities showed that the lateral movement had the lower priority, the lateral movement was halted for $\frac{1}{2}$ hour to allow the third serial of column B to clear the intersection. The lateral movement then arrived at the crossroad at 1400, approximately 15 minutes after the last vehicle of the third serial of column B cleared the intersection. The dotted line in figure 11 indicates the originally scheduled crossing of this lateral movement; the solid line shows its rescheduled crossing time.
- (4) *Column C*. Column C was scheduled to move from Roland to Dundalk at a rate of march of 10 miles (16 km) in the hour and to make a 1-hour noon halt along the

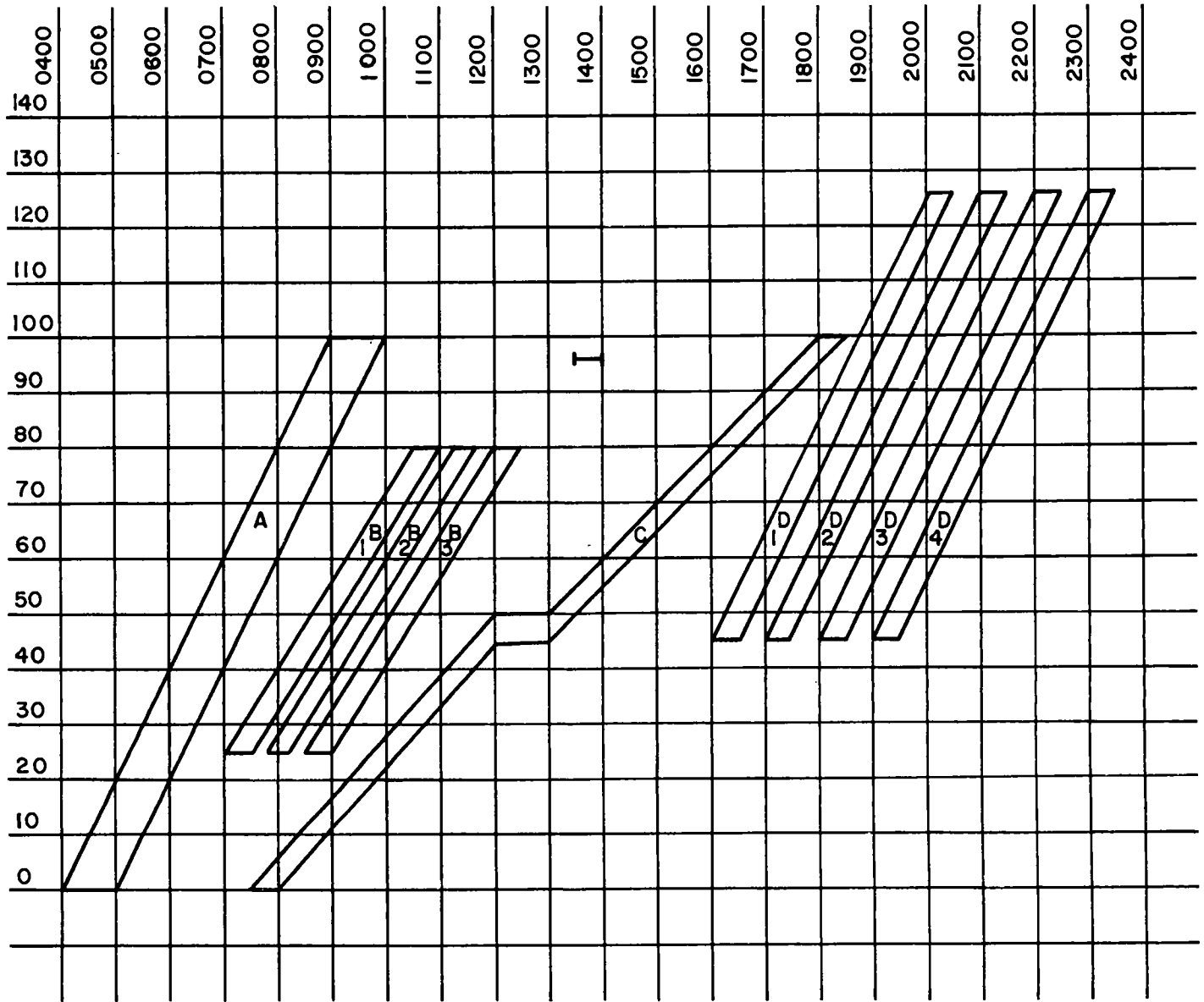
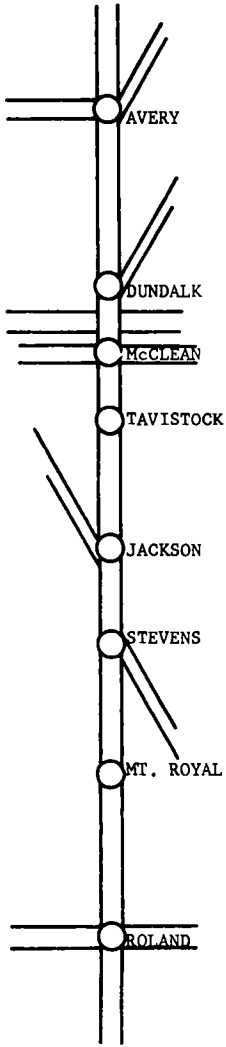

Figure 10. Plotting several columns over the same route.

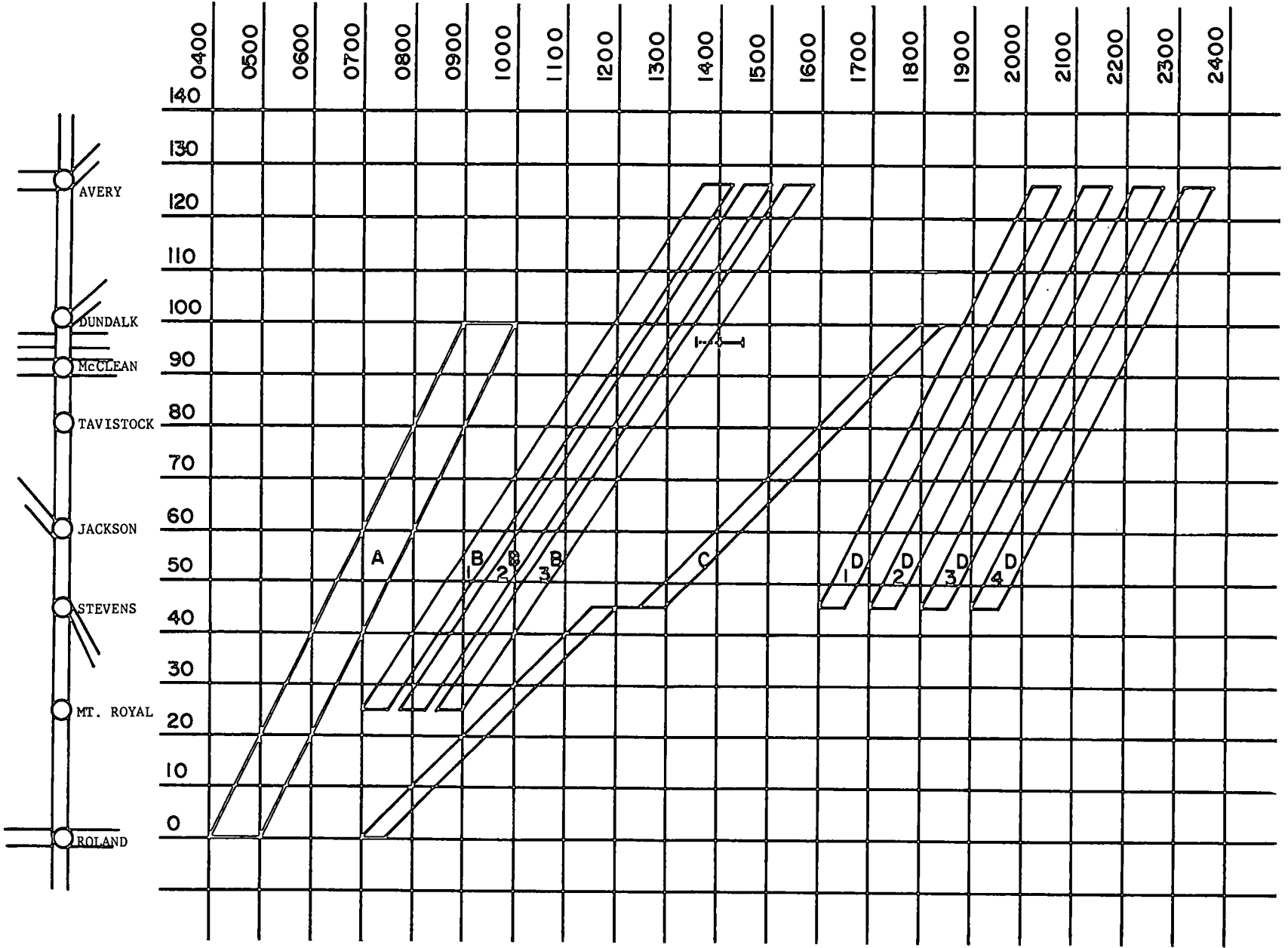

Figure 11. Completed graph reflecting operational adjustments.

road (after passing Stevens). At about 1045, traffic conditions deteriorated rapidly owing to the retrograde movement of engineer heavy equipment coming onto the route at Jackson and leaving it at Stevens. To alleviate this condition it was decided to halt column C at 1130 at the intersection in Stevens and to have the convoy move off the road into a parking area adjacent to the highway regulating point at that location. Then after the noon meal

and after passage of the engineer convoy, column C would proceed to destination. This required minimum schedule adjustment. (Note the method of plotting an off-the-road halt (fig. 11) as compared to a halt on the road (fig. 10).

- (5) *Column D.* Column D, consisting of 4 serials, scheduled to move from Stevens to Avery at a rate of march of 20 miles (32 km) in the hour, completed its march as scheduled.

By Order of the Secretary of the Army:

Official:

J. C. LAMBERT,
Major General, United States Army,
The Adjutant General.

HAROLD K. JOHNSON,
General, United States Army,
Chief of Staff.

Distribution:

Active Army:

DCSPER (2)	USACDCAVNA (5)	USACDCSWCAG (5)
ACSI (2)	USACDCCAA (2)	USACDCNG (1)
DCSLOG (2)	USACDCCBRA (3)	USACDCCCISG (6)
ACSFOR (2)	USACDCEA (10)	USALMC (3)
CORC (2)	USACDCTA (10)	USAIS (65)
CRD (1)	USACDCSWA (5)	USAINTS (3)
COA (1)	USAMC (15)	USAAMS (10)
CINFO (1)	USCONARC (10)	USAARMS (5)
TIG (1)	USACDC (10)	USAMPS (25)
TJAG (1)	ARADCOM (10)	USASCS (15)
TPMG (1)	ARADCOM Rgn (10)	USAQMS (5)
TSG (1)	OS Maj Comd (5)	USAOC&S (25)
OPO (1)	LOGCOMD (5)	USAOGMS (25)
CofEngrs (3)	Armies (25)	USAAVNS (15)
CofCh (1)	Corps (15)	USACAS (5)
USACDCAGA (5)	Div (10)	USAES (25)
USACDCARMA (4)	Div Arty (5)	USMA (10)
USACDCIA (5)	Bde (5)	Units org under fol TOE:
USACDCARTYA (2)	Regt/Gp (5)	1-252 (5)
USACDCINTA (2)	CC (5)	1-256 (3)
USACDCMSA (12)	Bn (5)	55-6 (5)
USACDCMPA (3)	USACDCIAS (1)	55-12 (5)
USACDCCEA (10)	USACDCCAG (5)	55-16 (3)
USACDCQMA (2)	USACDCCSSG (5)	55-62 (10)
USACDCOA (5)	USACDCEC (5)	55-118 (3)

NG: State AG (3); units—Same as active Army except allowance is one copy to each unit.

USAR: Units—Same as active Army except allowance is one copy to each unit.

For explanation of abbreviations used, see AR 320-50.





3000017519



1

FM 55-9 TRANSPORTATION SERVICES AND THE TRANSPORTATION BRIGADE IN THE FIELD ARMY—1965

