

Reference

U
408.3
A1 X
FM 55-46

15 May 67

FM 55-46

DEPARTMENT OF THE ARMY FIELD MANUAL

ARMY AVIATION TRANSPORT SERVICES AND UNITS IN THE FIELD ARMY



HEADQUARTERS, DEPARTMENT OF THE ARMY

MAY 1965

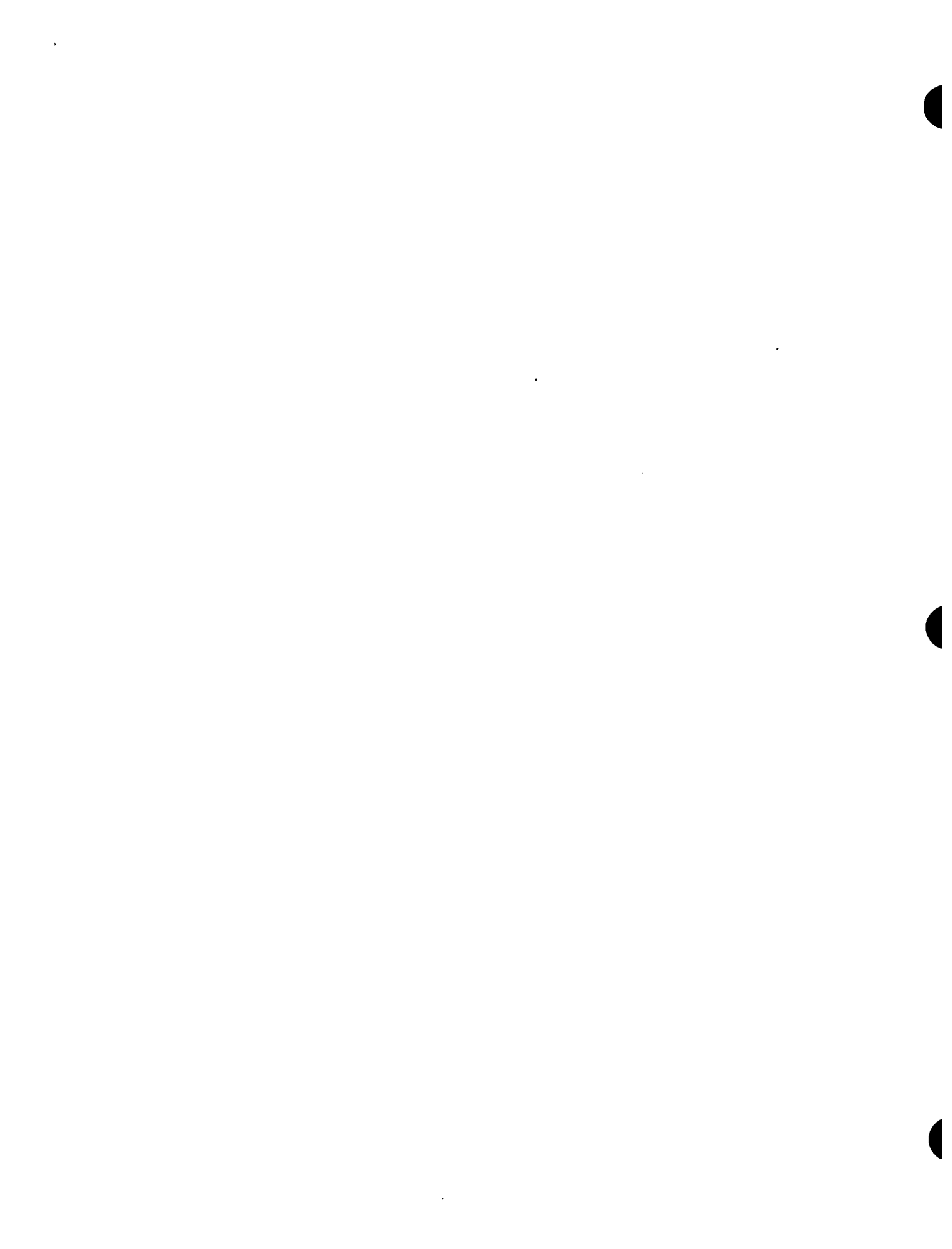

FIELD MANUAL }
No. 55-46 }HEADQUARTERS
DEPARTMENT OF THE ARMY
WASHINGTON, D.C., 19 May 1965ARMY AVIATION TRANSPORT SERVICES AND UNITS
IN THE FIELD ARMY

| | Paragraph | Page |
|---|-----------|------|
| CHAPTER 1. INTRODUCTION | | |
| Purpose and scope | 1 | 3 |
| Mission of aviation units | 2 | 3 |
| Importance of air transportation in modern warfare | 3 | 3 |
| Tables of organization and equipment | 4 | 3 |
| 2. ARMY AVIATION ORGANIZATION | | |
| Section I. Basic organization and aircraft | | |
| Basic organization | 5 | 5 |
| Characteristics of aircraft | 6 | 6 |
| II. Task units | | |
| Aviation medium helicopter company (TOE 1-258) | 7 | 7 |
| Aviation fixed wing company (TOE 1-257) | 8 | 12 |
| III. Command units | | |
| General | 9 | 16 |
| Aviation battalion (TOE 1-256) | 10 | 17 |
| Aviation group (TOE 1-252) | 11 | 20 |
| CHAPTER 3. TRANSPORT AVIATION SUPPORT OPERATIONS | | |
| General | 12 | 30 |
| Offensive operations | 13 | 30 |
| Defensive operations | 14 | 31 |
| Retrograde operations | 15 | 32 |
| Counterinsurgency operations | 16 | 32 |
| CBR operations | 17 | 33 |
| Mountain, jungle, arctic, and desert operations | 18 | 33 |
| 4. TRAINING | | |
| Responsibilities | 19 | 35 |
| Officers and warrant officers | 20 | 35 |
| Enlisted personnel | 21 | 35 |
| Unit training | 22 | 35 |
| Supported unit training | 23 | 36 |
| APPENDIX I. REFERENCES | --- | 37 |
| II. METHOD FOR DETERMINING AIRCRAFT REQUIREMENTS | --- | 39 |
| III. ASSEMBLY TECHNIQUES | --- | 41 |
| IV. AIRCRAFT LOADING AND MOVEMENT TABLES | --- | 44 |
| V. LIAISON OFFICER'S GUIDE | --- | 46 |
| VI. STANAG 3327, AIR TRANSPORTATION OF DANGEROUS CARGO | --- | 47 |
| VII. STANAG 3117, AIRCRAFT MARSHALLING | --- | 49 |
| VIII. STANAG 3465, SAFETY, EMERGENCY AND SIGNALLING PROCEDURES FOR AIR TRANSPORT AND AIRBORNE OPERATIONS | --- | 63 |

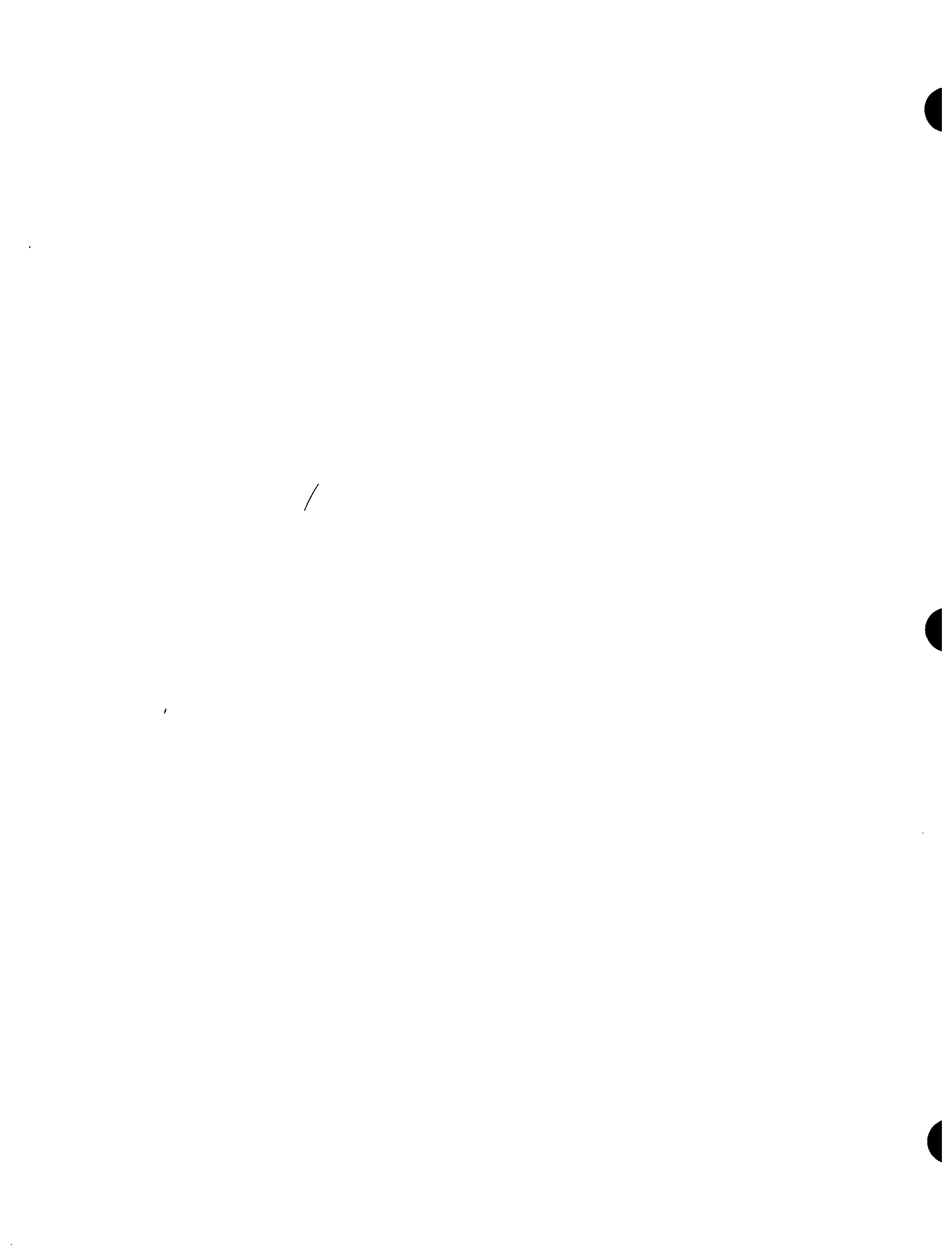

CHAPTER I

INTRODUCTION

I. Purpose and Scope

a. This manual serves as a reference on Army transport aviation services and units in the field army and as a guide for personnel assigned to units performing these services. This manual treats the mission of Army transport aviation units, the organization and allocation of units, the capabilities and limitations of the operating elements and their task equipment, and the normal procedures for determination and assignment of appropriate missions. This manual is intended to standardize operational procedures, to facilitate assignment of duties and responsibilities, and to increase overall efficiency in training and operations.

b. This manual covers the operational relationship between Army aviation units in the field army and supported units. It covers the command and administrative structure of Army aviation units, typical missions and operational procedures of transport aviation units, and the normal duties and responsibilities of key Army aviation personnel.

c. The material presented herein is applicable without modification to both nuclear and non-nuclear warfare.

d. Users of this manual are encouraged to submit recommended changes or comments to improve the manual. Comments should be keyed to the specific page, paragraph, and line of text in which the change is recommended. Reasons should be provided for each comment to insure understanding and complete evaluation. Comments should be forwarded to the Commanding Officer, U.S. Army Combat Developments Command Transportation Agency, Fort Eustis, Va. 23604.

2. Mission of Aviation Units

The mission of Army aviation units is to provide logistical airlift for movement of supplies and personnel and, if directed, for direct support of combat forces for a particular movement.

3. Importance of Air Transportation in Modern Warfare

Army transport aviation services within the field army are an integral part of a transportation system designed to provide efficient and effective transportation of personnel and things by Army aircraft. The complex transportation requirements of a modern mobile army demand overall planning, coordination, and control of operations to achieve an acceptable degree of economy and efficient utilization. The bulk and weight of major weapons and their associated equipment, the increase in ammunition resupply tonnages, and the supply and maintenance items required to keep a modern army mobile, place a burden on lines of communication. Even in a nonnuclear operation, the constant threat of its suddenly changing to a nuclear one demands greater dispersion of Army aviation units than would normally be considered economical. All these considerations emphasize the fact that Army transport aviation services must be efficiently organized and effectively employed to insure success in air lines of communication. Army transport aviation services must be prepared to play a major role in any military operation.

4. Tables of Organization and Equipment

Current tables of organization and equipment should be used in conjunction with this manual. These tables reflect detailed changes required by the development of new equipment and tech-

niques. Such changes demand the attention of assigned personnel, as would modifications authorized by major commanders, but would not warrant the publication of a change to this manual. The principles of organization and effective utilization of equipment remain constant. Training or employment based upon these principles retains its validity under the varying situations of modern warfare.

a. The basic units of the Army aviation organization are the aviation (helicopter and fixed wing) companies. Aviation companies are organized as separate companies capable of operating independently in the field. An aviation battalion is provided to give centralized command. The battalion may be tailored by attachment of aviation medium helicopter and aviation fixed wing companies are required. The usual composition of the aviation battalion is described in paragraph 10. The headquarters and headquarters company of the battalion provides command, control, staff planning and administrative supervision for two to seven aviation companies. Further centralization of command is achieved through the employment of an aviation group headquarters to control four aviation battalions, four aviation fixed

wing companies, and eight aviation helicopter companies. Organization of the aviation group is discussed in paragraph 11. The aviation group is a major subordinate element of the transportation brigade in the field army support command (FASCOM). This type organization provides the flexibility of operational command that is necessary to successful combat service support. The complete field army support command is designed to support a field army of three corps of four divisions each, engaged in sustained land combat.

b. Tables of organization and equipment applicable to Army aviation units provide for a full, reduced, or augmented complement of personnel and equipment, but aviation units are not adaptable to organization under the type B column of the TOE. Army aviation units can be adapted to operate with reduced personnel and equipment during noncombat periods or for limited periods of combat.

c. All references in this manual to tables of organization and equipment give the basic number only. Such references apply to either the tables identified by the basic number only or those identified by a basic number and suffix, whichever is current.

CHAPTER 2

ARMY AVIATION ORGANIZATION

Section I. BASIC ORGANIZATION AND AIRCRAFT

5. Basic Organization

The organization of Army aviation units is functional. Functions common to all units, regardless of type or size, are therefore reflected by similar subdivisions. Each unit consists of a headquarters element, which includes personnel who control or assist in the control of the unit and who provide administrative, supply, and service support; a maintenance element, which provides organizational maintenance services; and appropriate task elements, which form the major part of the organization. The basic characteristics of these elements and the primary duties and responsibilities normally assigned to key personnel are outlined in *a* through *c* below. Variations may be made at the discretion of the commander, within limits prescribed by higher authority, to effect optimum utilization of personnel for the accomplishment of his assigned missions in a specific situation. This command prerogative must be preserved to the greatest practicable extent at all levels to maintain operational flexibility.

a. Headquarters Element. The size of the headquarters element and the allocation of duties and responsibilities to its authorized personnel vary with the complexity of the unit and the variety of its normally assigned tasks. The unit headquarters is normally divided into a command group (for control) and a service group (for administration, supply, and service support). At battalion or higher level, the headquarters element is a headquarters and headquarters company or detachment. At this level, a staff is provided to assist the commander. Duties and responsibilities of staff personnel are based upon the functions of command (FM 101-5). The headquarters of the

aviation companies, though not subdivided by TOE, also contain a command group and a service group. A brief description follows:

- (1) *Command group.* The primary responsibility of the company commander is the successful performance of the unit's assigned mission under all conditions (garrison or combat). This includes responsibility for the training discipline, control, administration, and welfare of assigned personnel and for the security, maintenance, and proper utilization of all authorized equipment. The operations officer, first sergeant, and communications chief form the company command group to assist the commander in discharging these responsibilities.
- (2) *Service group.* The service group of the company headquarters provides for the company supply and mess. Major duties of the service group are performed by the supply sergeant and the mess steward.

b. Maintenance Element. Effective aircraft maintenance is a prerequisite of successful operation. The maintenance responsibility is therefore one which no commander can afford to neglect. The company commander personally insures effective maintenance by emphasis on maintenance in individual and unit training programs, by inspection of equipment and by provision of a realistic organizational maintenance program. The capabilities of the company are dependent upon aircraft availability, and normally increases in proportion to the effectiveness or organizational maintenance. The size of the maintenance element, type and

amount of equipment, and personnel skill levels are determined by the type and amount of task equipment authorized and assigned by the appropriate TOE. Every member of the maintenance platoon or section must be proficient in his MOS and thoroughly qualified for his position skill level. The leader of the maintenance element is a rated commissioned officer qualified as an aircraft maintenance officer. He is the advisor to and functional representative of the company commander in all maintenance matters. Since he directs and supervises all activities of the maintenance element, he must be an efficient manager. He plans maintenance operations, provides for emergency repairs, and plans the arrangement of tools and equipment to provide efficient service and repairs. He is responsible for the preparation of forms, records, and reports showing the status of organizational maintenance. He insures the adequate supply and authorized stockage of maintenance items and repair parts through timely requisition and constant control. He assists the commander in planning the unit maintenance program and preparing the maintenance portion of the unit SOP.

c. Task Element. The task elements of the Army aviation company are its operating platoons. The platoons are purely operational and have no organic administrative, supply, or maintenance personnel; when operating independently over extended periods, such personnel may be attached. The commander of each platoon is a command representative of the company commander at the platoon level. He is responsible to the company commander for the training, guidance, and supervision of his platoon in compliance with company policies, orders, and directives. Platoon commanders are assigned additional company duties to qualify them for promotion and to assist the company commander. These duties are normally rotated among the company junior officers and include such assignments as mess officers, supply officer, motor officer, security officer, administrative officer, and other assignments of a temporary nature.

6. Characteristics of Aircraft

a. General. The characteristics of transport medium helicopters and fixed wing aircraft are described in *b* and *c* below and are given as a

guide only. Allowable cargo loads and maximum ranges vary greatly with temperature, elevation, wind, and other variables at the time of a mission. It must therefore be understood that these variables preclude the possibility of providing a figure for the allowable cargo load that will remain constant. The figure given for the maximum numbers of troop seats should only be used as a guide in load planning.

b. CH-37 Helicopter.

- (1) *Description.* The CH-37 is a twin-engine medium-transport helicopter.
- (2) *Speed.* Cruise speed with payload is 80 knots (148 km per hour).
- (3) *Allowable cargo load for a given distance (one way).*
7,820 pounds at 50 nautical miles (92.6 km).
6,995 pounds at 100 nautical miles (185.2 km).
- (4) *Cargo transport provisions.*
 - (a) *Cargo compartment.*
Length: 364 inches.
Width: 81 inches.
Height: 67 inches.
Cargo space 1,142 cubic feet.
 - (b) *Cargo nose door (clamshell).*
Width: 87 inches:
Height: 67 inches.
 - (c) *Cargo side door.*
Width: 72 inches:
Height: 72 inches.
 - (d) *Cargo loading hatch.*
Location: Center of cabin floor.
Dimension: 72 inches by 48 inches.
 - (e) *Cargo handling facilities.*
Monorail: 2,000-pound capacity.
Electric winch.
 - (f) *External sling capacity.* 10,000 pounds.
- (5) *Troop transport provisions.*
Maximum number of troop seats: 23
troop seats at 240 pounds per man,
maximum number of litters: 24.
- (6) *Rotor diameter.* 72 feet.
- (7) *Maximum gross weight.* 31,000 pounds.
- (8) *Maximum range with payload (with 30-minute fuel reserve).* 180 nautical miles (334 km).

c. *CH-47 Helicopter.*

- (1) *Description.* The CH-47 is a twin-turbine-engine, medium-transport helicopter.
- (2) *Speed.* Cruise speed with payload is 130 knots (240 km per hour).
- (3) *Allowable cargo load for a given distance (one way).*
16,372 pounds at 50 nautical miles (92.6 km).
15,757 pounds at 100 nautical miles (185.2 km).
- (4) *Cargo transport provisions.*
 - (a) *Cargo compartment.*
Length: 360 inches.
Width: 90 inches.
Height: 78 inches.
Cargo space: 1,462 cubic feet.
 - (b) *Cargo door (rear).*
Width: 90 inches.
Height: 78 inches.
 - (c) *Cargo handling facilities.*
Hydraulic winch.
Hook hydraulic system.
 - (d) *External sling capacity.* 16,000 pounds.
- (5) *Troop transport provisions.*
Maximum number of troop seats: 33 at 240 per man.
Maximum number of litters: 24
- (6) *Rotor diameter:* 98 feet, 2 inches.
- (7) *Maximum gross weight:* 33,000 pounds.
- (8) *Maximum range with payload (with 30-minute fuel reserve):*
200 nautical miles (370.4 km).

d. *CV-2B (Caribou) Aircraft.*

- (1) *Description.* The CV-2B Caribou is a twin-engine Army transport aircraft.
- (2) *Speed.* Cruise speed with payload is 180 knots (334 km per hour).
- (3) *Allowable cargo load for a given radius (with 30-minute fuel reserve).*
8,164 pounds at a radius of 50 nautical miles (92.6 km).
7,800 pounds at a radius of 100 nautical miles (185.2 km).
7,000 pounds at a radius of 200 nautical miles (370.4 km).
- (4) *Cargo transport provisions.*
 - (a) *Cargo compartment.*
Length: 28 feet 9 inches to forward edge of loading ramp; 32 feet 6 inches to aft edge of loading ramp.
Width: 73½ inches.
Height: 74 inches.
Cargo space: 1,150 cubic feet.
 - (b) *Cargo door.*
Width: 73½ inches.
Height: 74 inches.
- (5) *Troop transportation provision.*
Maximum number of troop seats: 32 at 240 pounds per man.
Maximum number of litters: 14.
Maximum number of ambulatory: 8.
- (6) *Maximum gross weight.* 28,500 pounds.
- (7) *Maximum range with payload (with 30-minute fuel reserve).*
1,010 nautical miles (1870.5 km).

Section II. TASK UNITS

7. Aviation Medium Helicopter Company (TOE 1-258)

a. *Mission.* The mission of the aviation helicopter company is to provide aerial transport of supplies and personnel along a combat zone air line of communications and to provide support to units engaged in combat as required.

b. *Organization.* The organization of the aviation helicopter company is shown in figure

1. The company is normally attached to a headquarters and headquarters company, aviation battalion (TOE 1-256).

c. *Capabilities.*

- (1) At full strength, the aviation helicopter company is capable of the following:
 - (a) Operation of one heliport with facilities for visual and instrument terminal air traffic control.

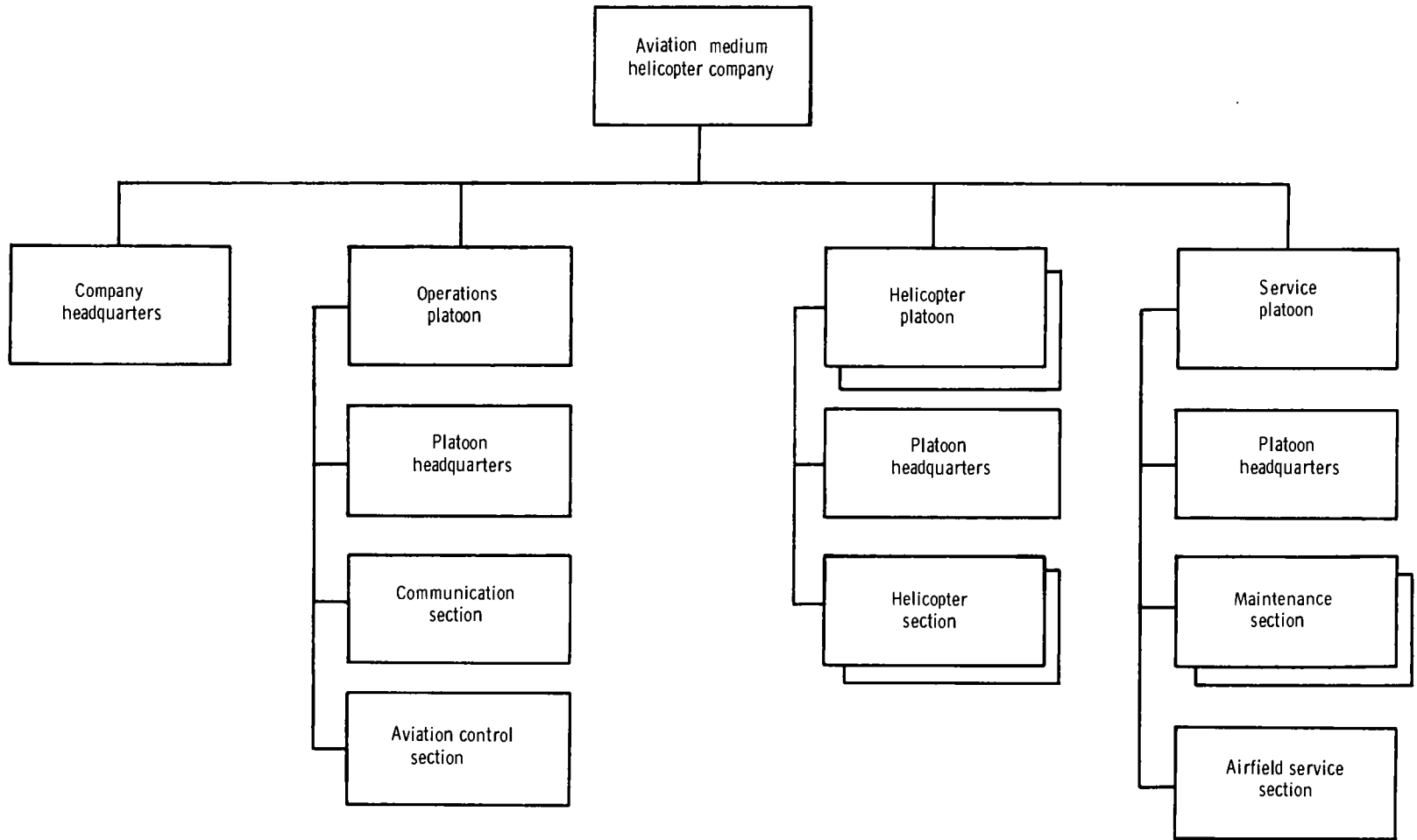

Figure 1. Aviation medium helicopter company, aviation battalion.

- (b) Transport of troops and/or supplies under day, night, or limited-visibility conditions.
- (c) Aerial mobility and aerial supply and resupply of combat forces in the combat zone.
- (d) Transport of nuclear weapons and their component parts and equipment.
- (e) Augmentation of Army Medical Service aeromedical evacuation elements.
- (f) Transport of the following in one lift as maximum effort, with all 16 helicopter available and operating, within a radius of 75 nautical miles (138.9 km) at sea level under standard day conditions:

| Type of helicopter | Troops | | Cargo | |
|--------------------|--------------|----|--------|-----|
| | (240 pounds) | OR | (tons) | OR |
| 16 CH-37 | 368 | | 46.4 | 384 |
| 16 CH-47 | 528 | | 64 | 384 |

For sustained effort, these capabilities are reduced or adjusted by an aircraft availability factor which is dependent on the operation.

- (2) Using all organic vehicles and helicopters, the company is 100 percent mobile.
- (3) When properly augmented by appropriate elements and skills, the company is self-sufficient.
- (4) The company has a limited capability for defending itself and its installation against enemy ground attack. Members of the company can engage in effective, coordinated defense of the units area or installation when required.

d. Limitations.

- (1) The aviation helicopter company is not adaptable to organization under the type B column of TOE 1-258.
- (2) The company's capability is reduced by one or a combination of the following factors:
 - (a) Provisions of personnel for an organic security force.
 - (b) Periods of maximum effort (continuous 24-hour operation).

- (c) Reduction in or loss of personnel.
- (d) Loss of and reduced availability of operational helicopters.

- (3) The effectiveness of the company is reduced during periods of darkness or during adverse weather conditions.

e. Planning and Coordination. The company receives daily missions from the battalion for scheduled and unscheduled transport of cargo and personnel over an air line of communication. Missions are normally shorter than those received by the aviation fixed wings company and are usually in areas where fixed wing landing strips are not available. When the company is assigned a transport mission, the commander takes immediate steps to effect liaison with the supported unit. To insure that supported units are indoctrinated in methods of determining aircraft requirements, assembly techniques, and aircraft loading and movements control, the procedures outlined in appendixes II, III, and IV should be used as a guide. Planning then continues until loading of the supported unit is complete.

f. Operations.

- (1) *General.* The aviation medium helicopter company provides the personnel and equipment to control and supervise company operations and to conduct around-the-clock flight operations. The company normally operates under the control of an aviation battalion, but it may be attached to a division or placed in direct support of a division for a specific mission. The effect of diverting the company from a logistical role to a tactical direct support role must always be carefully considered as the requirement for logistical support of combat troops is as important as the tactical movement of combat troops.
- (2) *Company headquarters.* The company headquarters commands and controls the company. The company headquarters contains the company commander, first sergeant, mess steward, supply sergeant, first cook, armorer, company clerk, cook, cook's helpers, and supply clerk.

(3) *Operations platoon.*

(a) *Platoon headquarters.* The operations platoon headquarters establishes and operates the company base heliport and coordinates and assigns flight missions to insure efficient use of assigned or attached aircraft. It coordinates necessary flight planning with flight operations centers and maintains necessary flight records of company personnel. The operations platoon headquarters contains the operations officer, flight operations chief, crew chief, senior flight operations specialists, clerk typist, and flight operations specialists.

(b) *Communication section.* The communication section supervises and participates in the establishment, operation, and maintenance of the communication system of the company (figs. 2 and 3). The communication section contains the communications chief, GCA equipment repairman, radioteletypewriter team chief, aviation electronic equipment repairman, radioteletypewriter operator, senior switchboard operator, and switchboard operator.

(c) *Aviation control section.* The aviation control section provides terminal traffic control at the base airfield during day, night, and inclement weather operations. The aviation control section contains the senior control tower operator, senior landing control operator, control tower operator, and landing control operator.

(4) *Helicopter platoon.*

(a) *Platoon headquarters.* The two helicopter platoon headquarters provide command and control over the helicopter sections. Each helicopter platoon contains a platoon commander, platoon sergeant, and light truck driver.

(b) *Helicopter section.* The four helicopter sections provide the tactical and logistical air transport capability of the company. Each helicopter section contains a section commander, assistant section commander, rotary wing aviators, and flight engineers. Each helicopter section is equipped with 4 medium helicopters, for a total of 16 within the company.

(5) *Service platoon.*

(a) *Platoon headquarters.* The service platoon headquarters supervises the organizational maintenance and service of the company helicopters, vehicles, and allied equipment. It also supervises the activities of the airfield service section. The service platoon headquarters contains the platoon commander, helicopter repair technician, platoon sergeant, motor sergeant, technical inspector, aviation electronics equipment mechanic, aircraft parts specialist, shop clerk, records clerk, supply clerk, wheel vehicle mechanic, wrecker operator, and wheel vehicle mechanic's helper.

(b) *Maintenance section.* The two maintenance sections provide for the inspection and organizational maintenance of assigned aircraft. Each maintenance section contains a maintenance supervisor, senior helicopter mechanic, helicopter mechanic, and helicopter mechanic's helper.

(c) *Airfield service section.* The airfield service section provides night lighting, tiedown, and POL servicing and refueling, using the fuel trucks in the section. When augmented, the section provides crash rescue service. The airfield service section contains the section chief, aircraft refueling specialist, powerman, petroleum storage specialist, and crash rescue specialists.

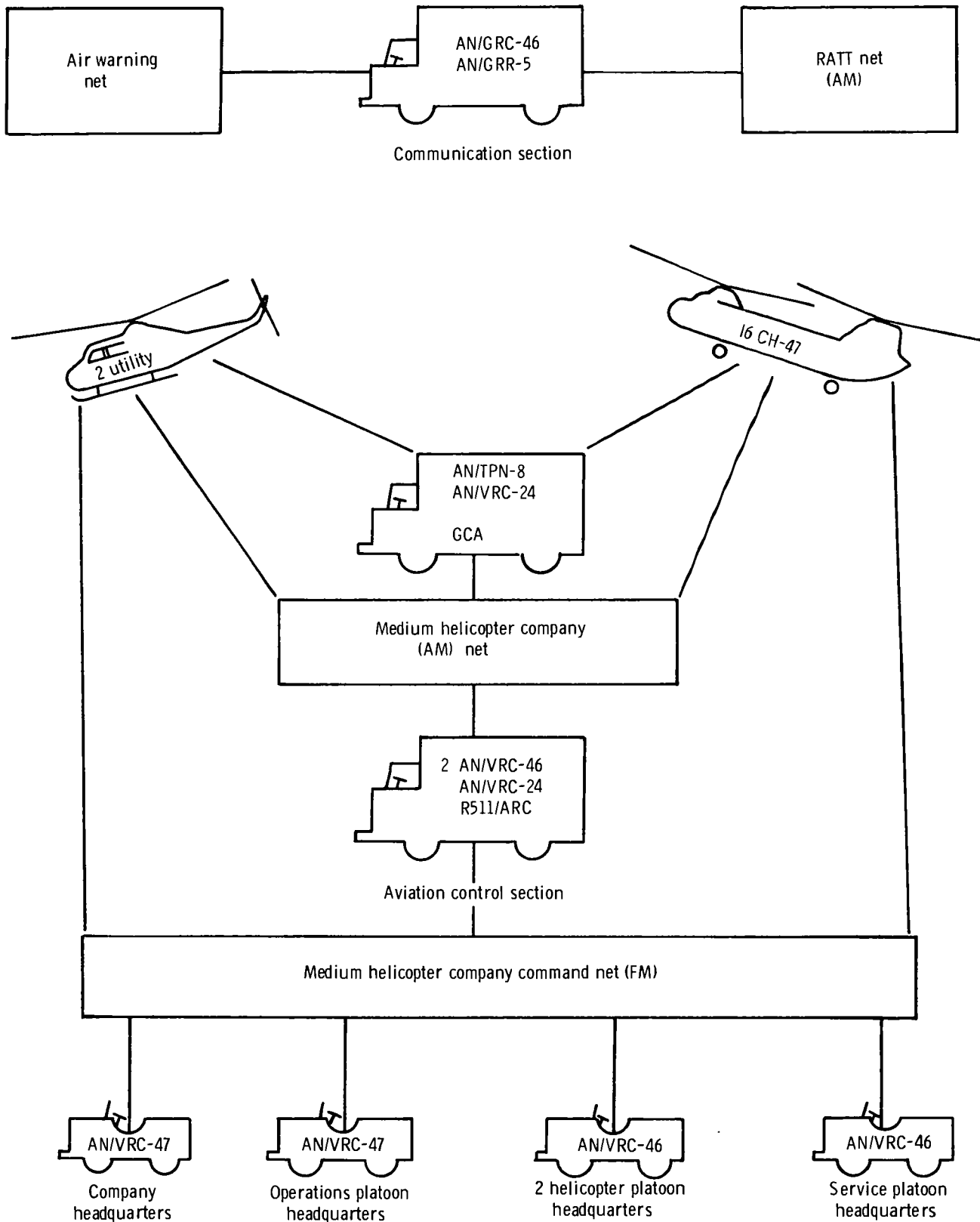

Figure 2. Radio communication net, aviation medium helicopter company, aviation battalion.

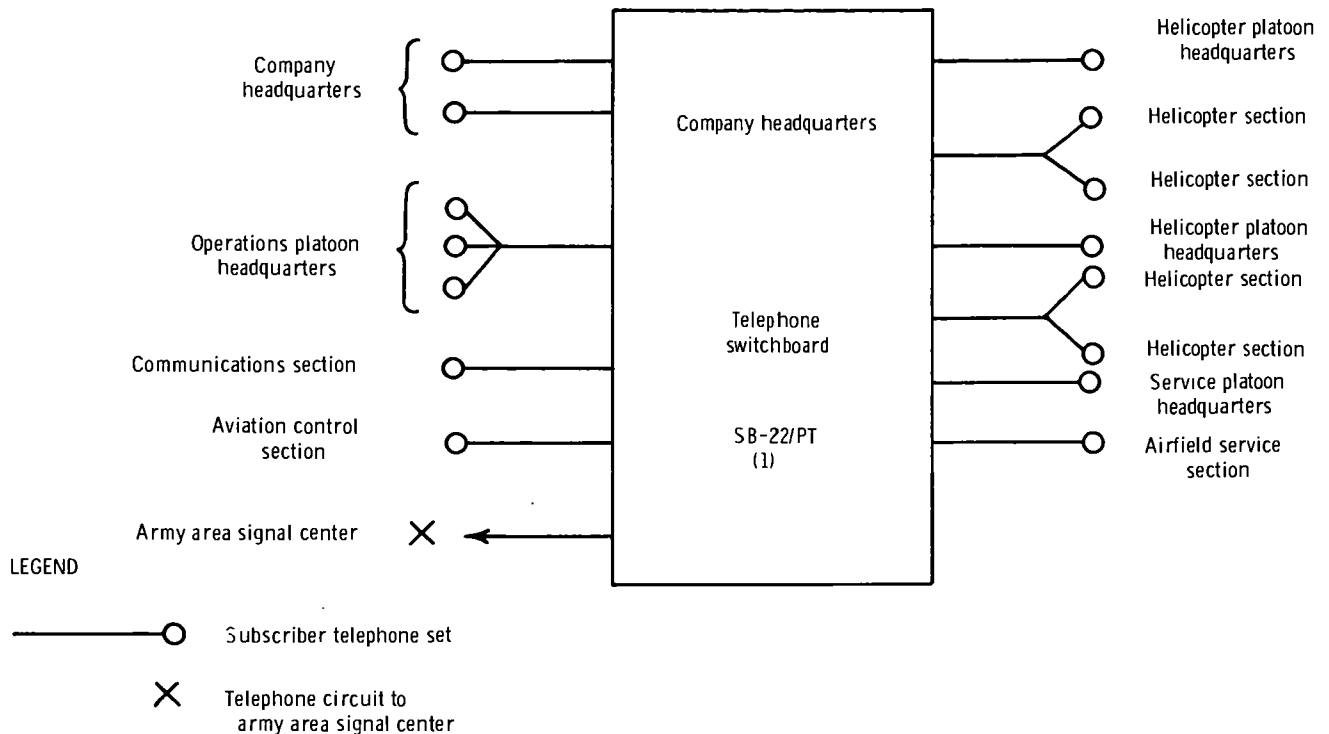

Figure 3. Wire communication net, aviation medium helicopter company, aviation battalion.

8. Aviation Fixed Wing Company (TOE 1-257)

a. Mission. The mission of the aviation fixed wing company is to provide airlift for movement of supplies and personnel along an air line of communication and, as directed, to provide tactical airlift of combat units and air resupply of units engaged in combat operations.

b. Organization. The organization of the transport aviation fixed wing company is shown in figure 4. The aviation fixed wing company is normally attached to a headquarters and headquarters company, aviation battalion (TOE 1-256).

c. Capabilities. At full strength, the aviation fixed wing company is capable of the following:

- (1) Operation of one airfield with facilities for visual and instrument terminal air traffic control.
- (2) Transport of troops and/or supplies in day and night operations.
- (3) Aerial resupply of combat forces in the combat zone.

- (4) Transport of nuclear weapons and their component parts and equipment.
- (5) Augmentation of Army Medical Service aeromedical evacuation elements.
- (6) Transport of the following in one lift as maximum effort, with all 16 CV-2B airplanes available and operating, within a radius of 150 nautical miles (277.8 km): 368 troops (240 pounds each), or 50 tons of cargo or 288 liters. For sustained effort, these capabilities are reduced or adjusted by an airplane availability factor that is dependent on the duration of the operation.

d. Limitations.

- (1) The aviation fixed wing company is not adaptable to organization under the type B column of TOE 1-257.
- (2) The effectiveness of the company is reduced during periods of darkness or during adverse weather conditions.
- (3) The company's capability is reduced by any one or a combination of the following factors:

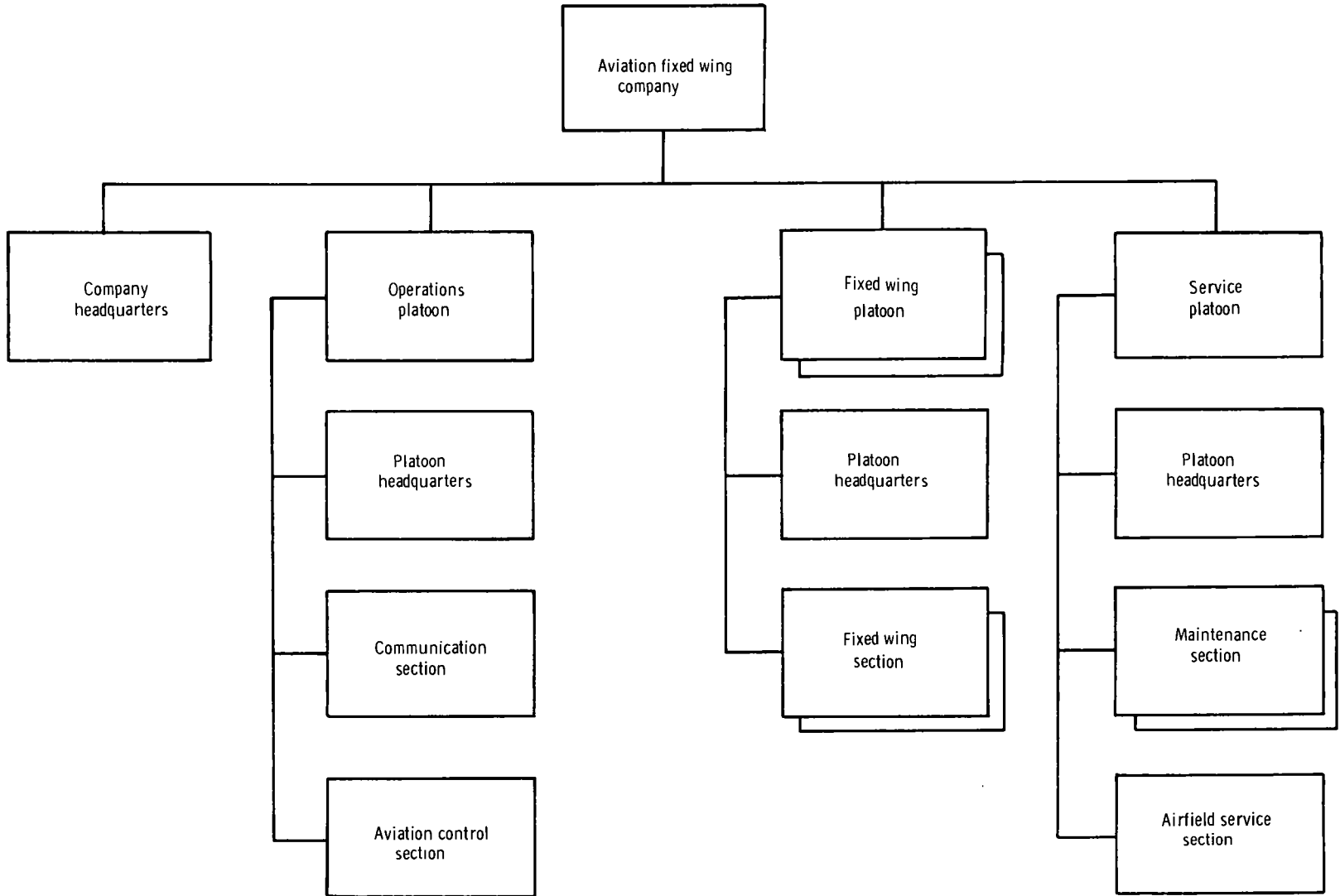

Figure 4. Aviation fixed wing company, aviation battalion.

- (a) Provision of personnel for an organic security force.
- (b) Periods of maximum effort (continuous (24-hour operation)).
- (c) Reduction in or loss of personnel.
- (d) Loss of and reduced availability of operational airplanes.

e. Planning and Coordination. The company receives daily missions from the aviation battalion in support of a movements program for the transport of cargo and personnel over an air line of communication. It provides for around-the-clock operation. Missions are normally longer than those received by aviation medium helicopter companies and are normally in areas where fixed wing landing strips are available. When missions are assigned, the commander takes immediate steps to effect planning and coordination. Planning and coordination continues until completion of the mission.

f. Operations.

- (1) *General.* The aviation fixed wing company provides the personnel and equipment to control and supervise company operations and to conduct around-the-clock operations. The company normally operates under the control of a transport aircraft battalion, but it may be attached to a division or placed in direct support of a division for a specific mission. To retain maximum flexibility of aircraft resources, the normal method of aircraft employment is on a mission basis.
- (2) *Company headquarters.* The company headquarters commands and controls the company. The company headquarters contains the company commander, first sergeant, mess steward, supply sergeant, first cook, armorer, company clerk, cook, cook's helper, and supply clerk.
- (3) *Operations platoon.*
 - (a) *Platoon headquarters.* The operations platoon headquarters receives and processes requests for aircraft and assigns flight missions to insure efficient use of all assigned aircraft.

The platoon headquarters establishes and operates the base airfield. It installs, maintains, and assists in the operation of the communication and navigational equipment utilized at the base airfield, and it provides terminal approach control. The operations platoon headquarters contains the flight operations officer, flight operations chief, senior flight operations specialist, clerk typist, flight operations specialist, and crew chief.

- (b) *Communication section.* The communication section supervises and participates in the establishment, operation, and maintenance of the communication system of the company (figs. 5 and 6). The communication section contains the communications chief, GCA equipment repairman, radioteletypewriter team chief, aviation electronic equipment mechanic, radioteletypewriter operator, senior switchboard operator, and switchboard operator.
- (c) *Aviation control section.* The aviation control section provides terminal traffic control at the base airfield during day, night, and inclement-weather operations. The aviation control section contains the senior control tower operator, senior landing control operator, control tower operator, and landing control operator.
- (4) *Fixed wing platoons.*
 - (a) *Platoon headquarters.* The fixed wing platoon headquarters provide command and control over the fixed wing sections. Each fixed wing platoon contains a platoon commander, platoon sergeant, and light truck driver.
 - (b) *Fixed wing section.* The four fixed wing sections provide the tactical and logistical air transport capability of the company. Each fixed section contains a section commander, an assistant section commander, fixed wing aviators, and

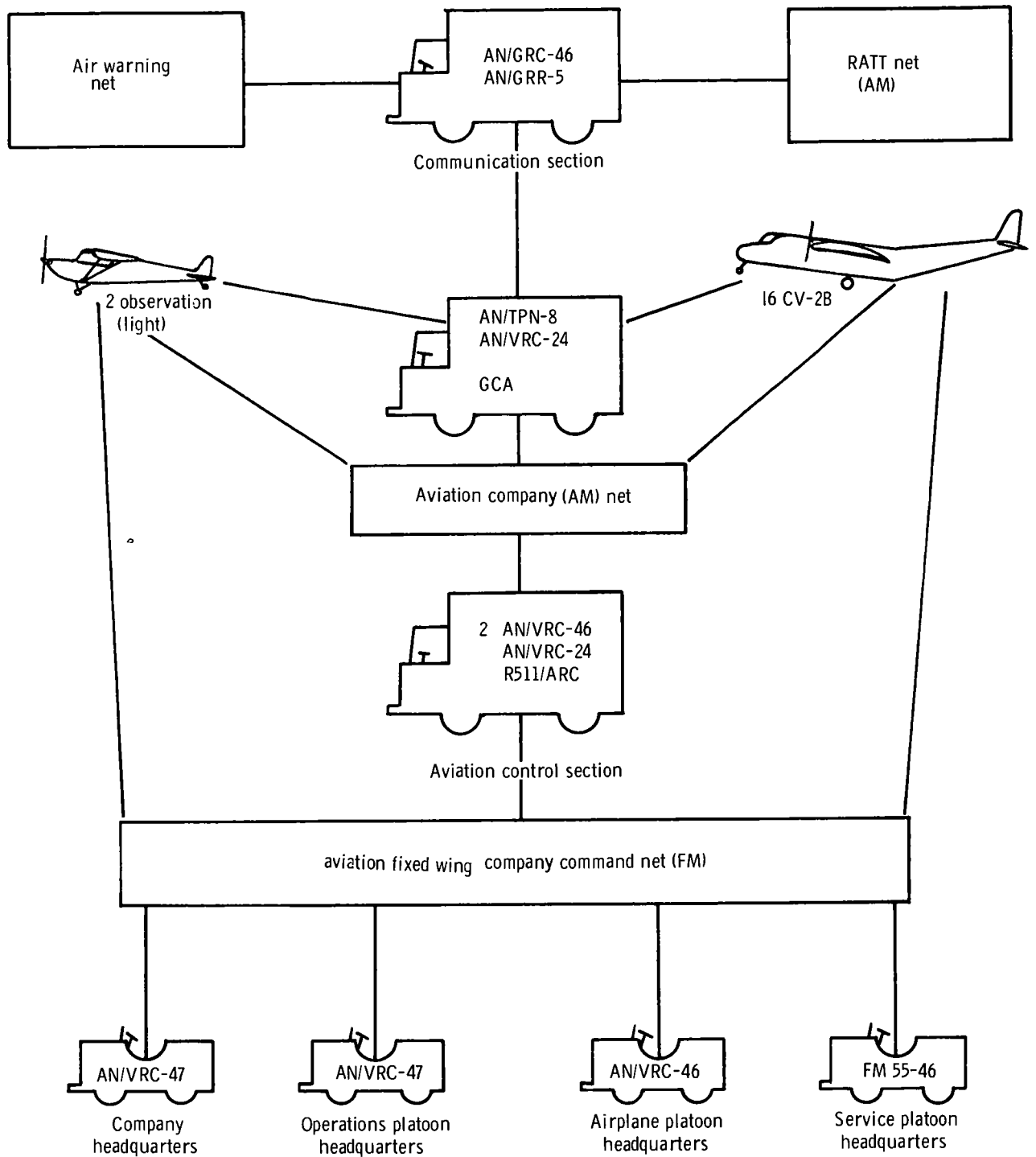
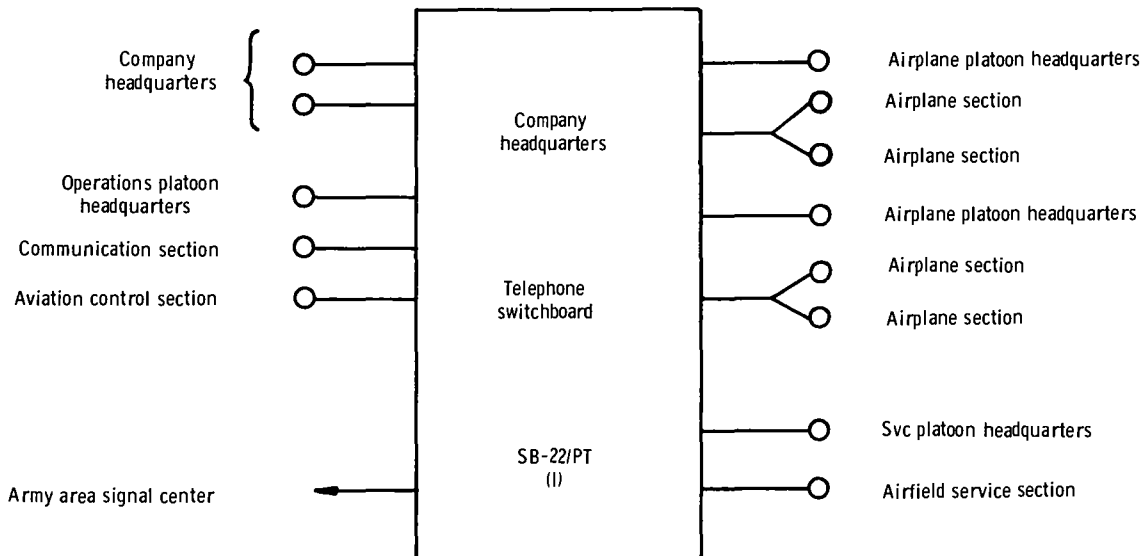

Figure 5. Radio communication net, aviation fixed wing company, aviation battalion.

flight engineers. Each fixed wing section is equipped with 4 medium transport airplanes, for a total of 16 in the company.

(5) Service platoon.

(a) Platoon headquarters. The service provides the organizational maintenance and service required for the



LEGEND

- Subscriber telephone set
- X Telephone circuit to army area signal center

Figure 6. Wire communication net, aviation fixed wing company, aviation battalion.

company aircraft, vehicles, and allied equipment. The service platoon headquarters provides control of the two maintenance sections and the airfield service section. The service platoon headquarters contains the platoon commander, aircraft repair technician, platoon sergeant, senior aircraft parts specialist, aviation electronics equipment mechanic, technical inspector, motor sergeant, aircraft parts specialist, shop clerk, records clerk, supply clerk, wheel vehicle mechanic, wrecker operator, and wheel vehicle mechanic helper.

(b) *Maintenance section.* The two maintenance sections provide for

the inspection and organizational maintenance of assigned aircraft. Each maintenance section contains a maintenance supervisor, senior aircraft mechanic, aircraft mechanic, and aircraft mechanic's helper.

(c) *Airfield service section.* The airfield service section provides night lighting, tiedown, and POL servicing and refueling, using the fuel trucks in the section. When augmented, the section provides crash rescue service. The airfield service station contains the section chief, aircraft refueling specialist, powerman, petroleum storage specialist, and crash rescue specialist.

Section III. COMMAND UNITS

9. General

Aviation command units are provided in the field army to coordinate and control the operations of aviation (helicopter and fixed wing)

units. The assignment of aviation units is carefully planned to provide the proper combination of aircraft in specific areas in order to increase the speed of response to require-

ments. Through routine status reports and communication monitoring, the next higher headquarters is constantly prepared to meet emergency requirements with the most suitable means available. Air movement of personnel and things along an air line of communication is coordinated and controlled by the transport aviation group.

10. Aviation Battalion (TOE I-256)

a. Mission. The aviation battalion, through assigned and attached companies, provides air transport for personnel, equipment, and supplies as part of an aviation group in support of a field army. The headquarters and headquarters company of the battalion provides command, control, staff planning, and administrative supervision for two to seven transport aviation companies.

b. Organization. The aviation battalion may be tailored by attachment of aviation medium helicopter and aviation fixed wing companies to suit the operational requirement. The usual composition of the aviation battalion is shown in figure 7. The headquarters and headquarters company, aviation battalion, is organized as shown in figure 8. It is normally assigned to an aviation group.

c. Capabilities.

- (1) At full strength, the battalion performs the following functions:
 - (a) Plans and supervises the employment of assigned or attached transport aircraft companies.
 - (b) Provides staff supervision and command guidance for organizational maintenance and logistical functions of assigned or attached units.
 - (c) Provides medical service, including emergency medical treatment, operation of aid station, evacuation of sick and injured, and supervision of sanitation. Assists in the supervision of medical training of non-medical personnel.
 - (d) Provides augmentation of aeromedical evacuation from the battlefield.
- (2) The battalion can be adapted to operate with reduced personnel and equipment during prolonged noncombat periods or for limited periods of combat.
- (3) The battalion has a limited capability for defending itself and its installa-

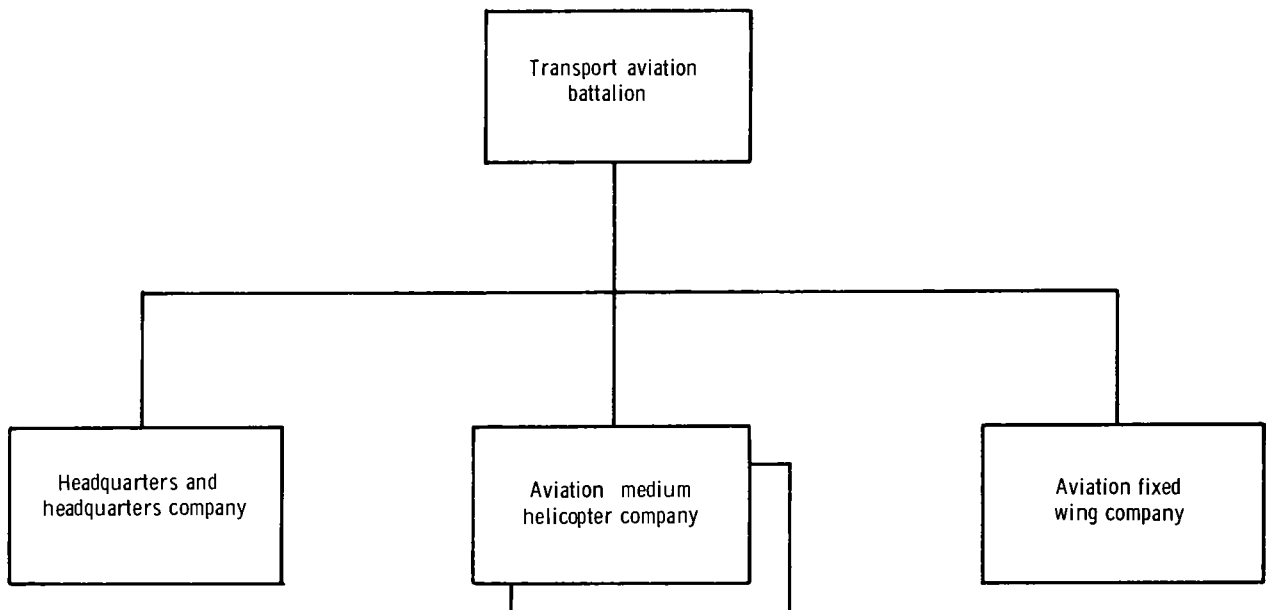

Figure 7. Aviation battalion, aviation group.

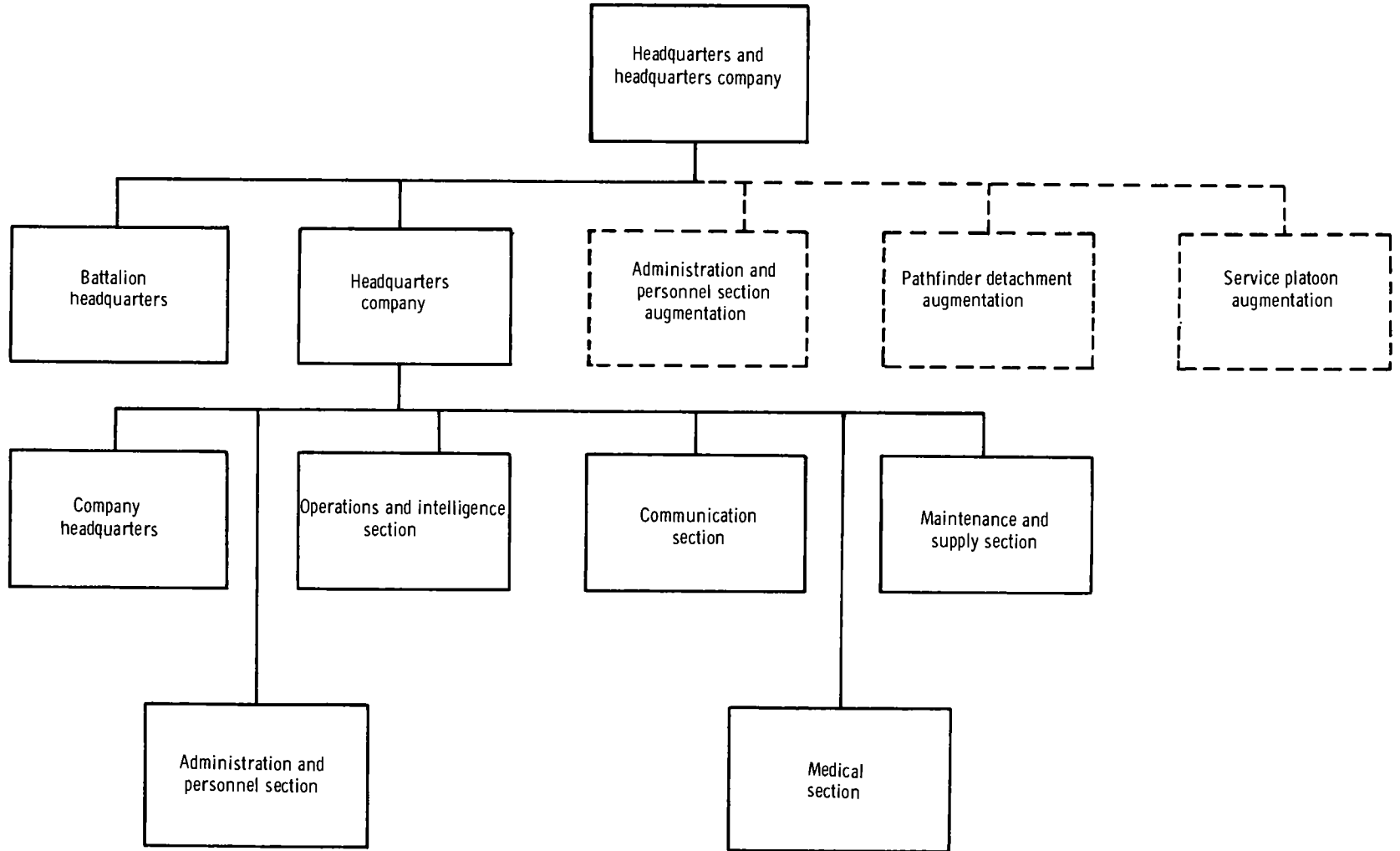

Figure 8. Headquarters and headquarters company, aviation battalion.

tions against ground attack. Personnel of the battalion, except medical personnel, can engage in effective, coordinated defense of the area or installation, when required. Medical personnel can only defend themselves, their patients, and their installation against enemy attack.

- (4) The battalion is 50 percent mobile utilizing all organic vehicles and aircraft.

d. Limitations. The aviation battalion has the following limitations:

- (1) The battalion is not adaptable to organization under the type B column of TOE 1-256.
- (2) The headquarters and headquarters company is authorized only those wheeled vehicles that are required for day-to-day operations. Because the battalion has only 50 percent mobility for movement and displacement, aerial or vehicular transportation must be furnished by assigned or attached aviation (helicopter and fixed wing) companies.
- (3) The effectiveness of the battalion is reduced during periods of darkness or during adverse weather conditions.

e. Operations.

(1) *General.*

- (a) The aviation battalion normally consists of a headquarters and headquarters company, two transport aviation medium helicopter companies, and one transport aviation fixed wing company. However, the battalion headquarters is capable of command and control of a battalion composed of two to seven companies of the same type of aircraft or a combination of helicopter and fixed wing companies. The battalion may have a terminal transfer company temporarily attached. The terminal transfer company is organized and equipped to transfer 900 short tons of cargo per day from one mode of transportation to another at air,

motor, rail, and small inland waterway terminals (TOE 55-118). The aviation battalion should be centrally located in relation to subordinate units.

- (b) The battalion or its elements normally operates on a mission basis within established priorities. The battalion receives missions from the aviation group or may receive aircraft requests direct from the major supported headquarters. Missions are assigned to subordinate companies based on their capabilities and the task to be performed. Liaison must be established between the supporting and supported elements. (See app V for information that should be obtained in order to coordinate and execute successful air operations.)

- (2) *Battalion headquarters.* The battalion headquarters is the command and control headquarters for the employment of all assigned or attached aviation units. The battalion headquarters contains the battalion commander, executive officer, adjutant (S-1), intelligence officer (S-2), operations officer (S-3), logistics officer (S-4), aviation medical officer, liaison officer, signal officer, aviation safety officer, and sergeant major.

(3) *Headquarters company.*

- (a) *Company headquarters.* The company headquarters provides administrative service for the battalion headquarters and headquarters company. These services pertain to individual requirements of assigned personnel, including mess, supply, quarters, supervision of nonduty-hour activities, and maintenance of administrative records. The company headquarters contains the company commander, first sergeant, supply sergeant, mess steward, first cook, cook, company clerk, and cook's helper.

- (b) *Administration and personnel section.* Personnel of the administra-

tion and personnel section are employed in the battalion headquarters. Personnel administration is performed by adjutant general personnel service units, which operate independently of the battalion. The administration and personnel section contains the personnel staff NCO, a clerk typist, and a light truck driver.

- (c) *Operations and intelligence section.* The operations and intelligence section assists the S-2 and S-3 in the organization, training, operations, and intelligence functions of the battalion headquarters. Personnel are provided for 24-hour operation and intelligence functions for sustained operations. The operations and intelligence section contains the assistant operations officer, operations sergeant, intelligence operations sergeant, assistant operations sergeant, senior movements specialist, clerk typist, general draftsman, and movements specialist.
- (d) *Communication section.* The communication section supervises and participates in the establishment, operation, and maintenance of the communication system of the battalion (figs. 9 and 10). The communication section contains the communications chief, radioteletypewriter team chief, radioteletypewriter operator, senior switchboard operator, manual teletypewriter operator, radio mechanic, senior message clerk, switchboard operator, message clerk, and wireman.
- (e) *Medical section.* The medical section furnishes emergency medical treatment, operates a battalion aid station, evacuates patients from dispersed elements of the battalion to the battalion aid station, and provides medical supervision of sanitation within the battalion. The medical section contains the section sergeant, field medical as-

sistant, senior medical aidman, clerk typist, ambulance driver, and medical aidman.

- (f) *Maintenance and supply section.* The battalion maintenance and supply section performs normal supply and maintenance functions for the battalion headquarters. It supervises and inspects all maintenance activities in the battalion. The maintenance and supply section contains the aircraft maintenance officer, unit supply technician, automotive maintenance technician, maintenance supervisor, battalion supply sergeant, motor maintenance sergeant, transportation parts supply sergeant, technical inspector, helicopter crew chief, ration distribution sergeant, reports clerk, signal parts supply specialist, transportation parts supply specialist, supply specialists, wheel vehicle mechanic, wheel vehicle mechanic helper, and supply clerk.

f. Command Relationships. Command relationship between the aviation battalion commander and his subordinate unit commanders and between the aviation battalion commander and the aviation group commander differ from conventional military command relationships only insofar as mission assignments, in the form of requests for aircraft, may be received direct from the major supported headquarters rather than through the aviation group. Responsibility for timely submission of reports and information as directed rests with the subordinate commander. Responsibility for overall efficiency and effectiveness of each level of command rests with the commander at that level. Close liaison is maintained between the aviation battalion and its supported units to assure the battalion commander of timely and accurate information for anticipatory planning and to keep him informed of the effectiveness of his subordinate unit's operations.

II. Aviation Group (TOE I-252)

a. Mission. The aviation group, through assigned and attached battalions, provides air transport for personnel, equipment, and sup-

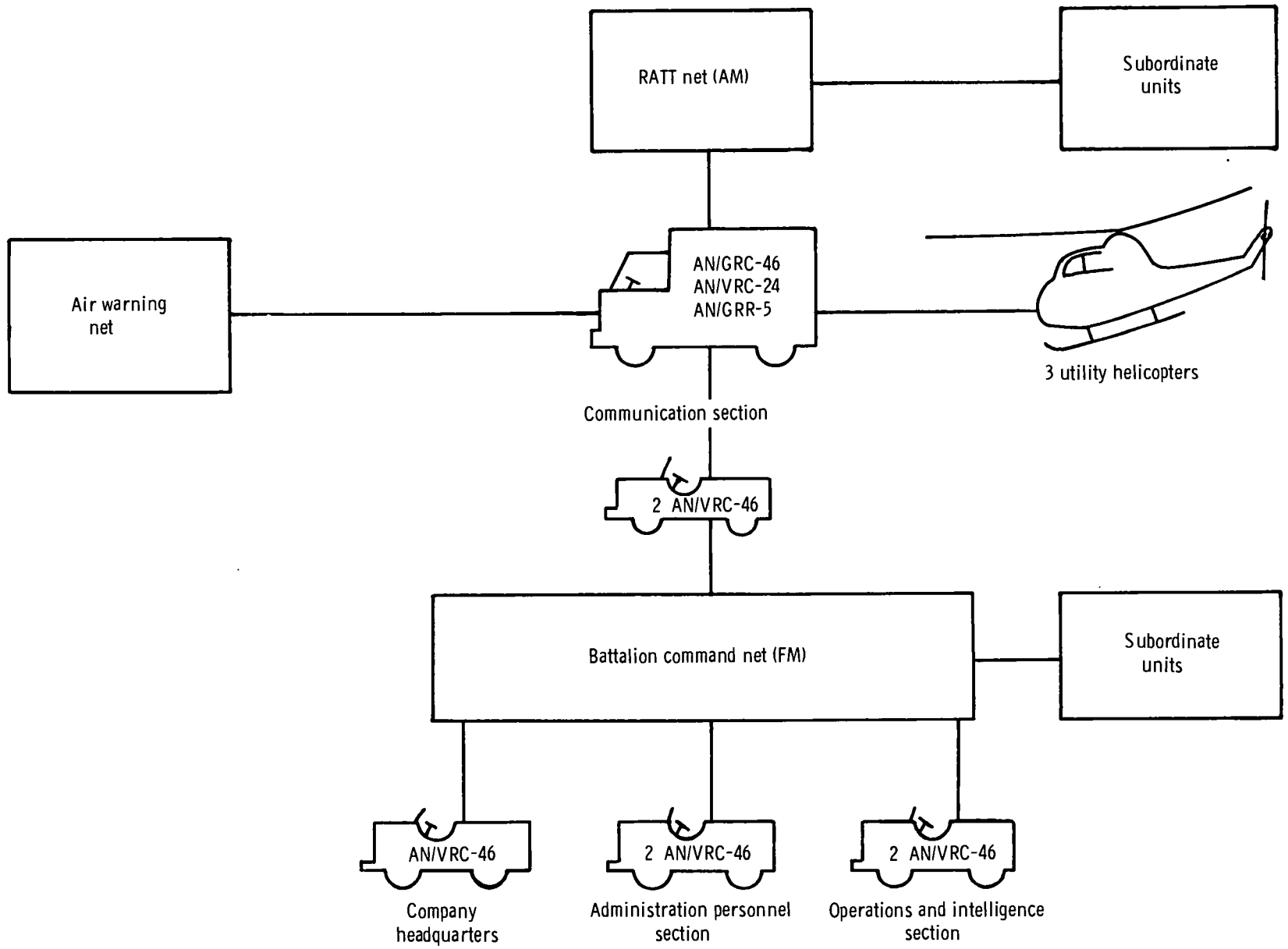

Figure 9. Radio communication net, aviation battalion, aviation group.

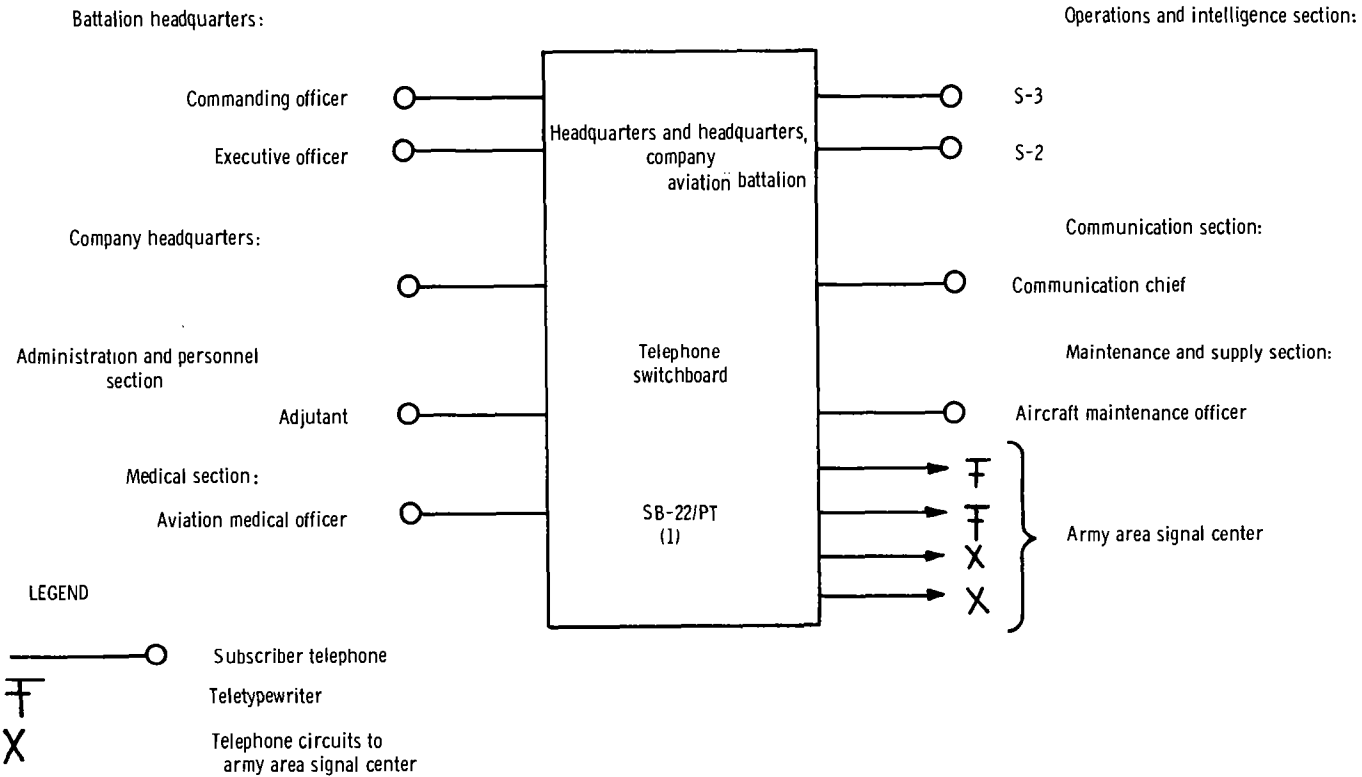

Figure 10. Wire communication net, aviation battalion, aviation group.

plies in a type field army. The headquarters and headquarters company of the group provides command, staff planning, and administrative control of aviation battalions.

b. Organization. The aviation group (fig. 11) is a major subordinate element of the field army support command (FASCOM). It contains a group headquarters and headquarters company; four headquarters and headquarters companies, aviation battalions; four aviation fixed wing companies; and eight aviation medium helicopter companies. The headquarters and headquarters company, aviation group, is organized as shown in figure 12, and is assigned to a transportation brigade.

a. Capabilities.

(1) The aviation group commands, plans for, and supervises the activity of four aviation battalions. It coordinates, inspects, and supervises the following group operations:

(a) Selection of the general area for subordinate units.

(b) Air transport operations, as follows:

1. Determining and evaluating air transport capabilities.
2. Allocating transport aircraft to major supported headquarters.
3. Providing adequate control of transport airlift units to furnish combat service support.

(c) Aircraft maintenance operations, as follows:

1. Coordinating subordinate units maintenance.
2. Analyzing subordinate unit aircraft maintenance operations to provide procedural guides and control procedures.

(2) The group provides sustained combat service support based on the transport of 100 short tons per division per day over a radius of 75 nautical miles (138.8 km). Movement of individual replacements and priority cargo is included in this mission. A secondary capability is the augmentation of tactical air mobility as directed by the army commander.

(3) The group can be adapted to operate with reduced personnel and equipment during prolonged noncombat periods or for limited periods of combat.

(4) Personnel of the group, except the chaplain, can engage in effective, coordinated defense of the area or installation when required. Medical personnel can only defend themselves, their patients, and their installation against enemy attack. The group has a limited capability for defending itself and its installation against enemy ground attack.

(5) The average transport capability of the aviation group is based on 75 percent aircraft availability and flying hours as outlined in SB 1-1. Detailed data concerning capabilities of the organization must be developed for each group, depending on the type of aircraft with which the unit is equipped. As an example, the transport capability of a group equipped with CV-2B airplanes and CH-47 helicopters is given below:

CV-2B aircraft (16 aircraft per company, 75 percent or 12 aircraft available, 150-nautical-mile (278 km) radius):

3.1 short tons per aircraft per sortie
x 2 sorties per day

6.2 short tons per aircraft per day
x 12 aircraft available

74.4 short tons per company per day
x 4 companies per aviation group

297.6 short tons total per day

CH-47 helicopters (16 helicopters per company, 75 percent or 12 helicopters available, 50-nautical-mile (96 km) radius):

4 short tons per helicopter per sortie
x 3 sorties per day

12 short tons per helicopter per day
x 12 helicopter available

144 short tons per company per day
x 8 companies per aviation group

1,152 short tons per total per day

Total short tons per aviation group (75 percent aircraft availability):

297.6 CV-2B daily capacity

1,152.0 CH-47 daily capacity

1,449.6 total daily capacity

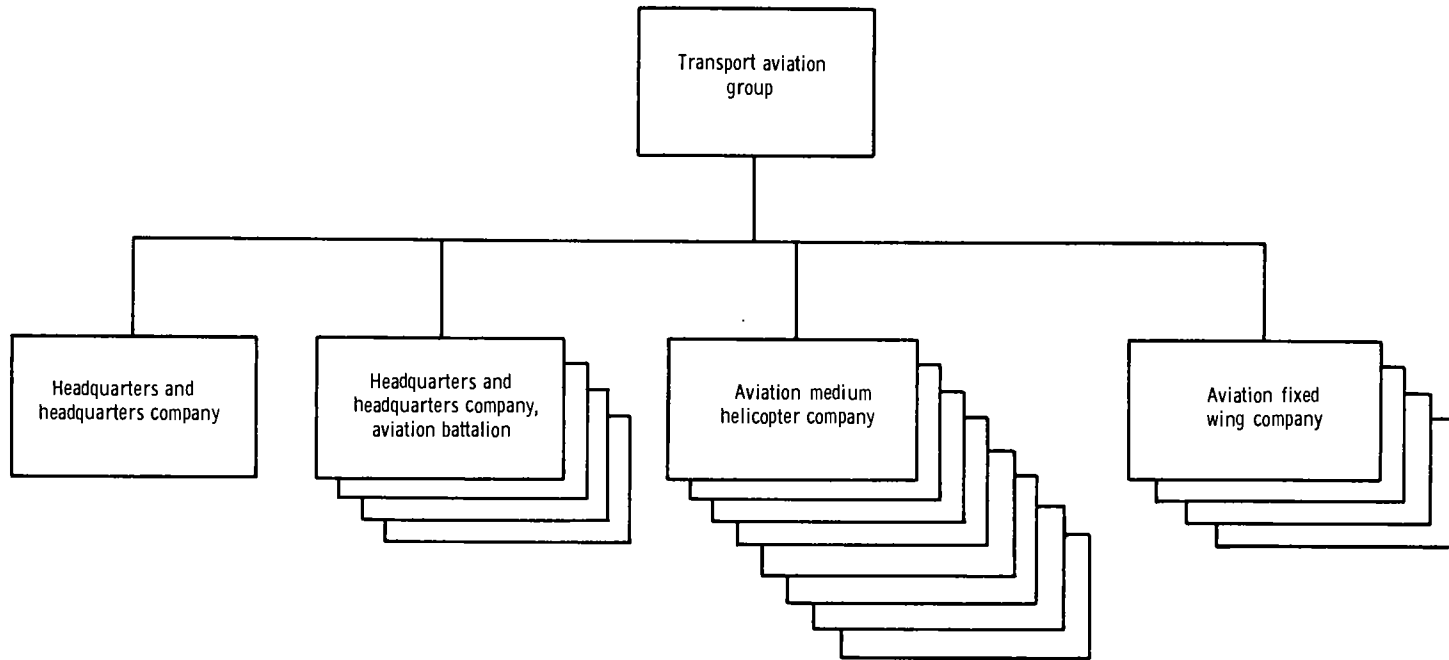

Figure 11. Aviation group.

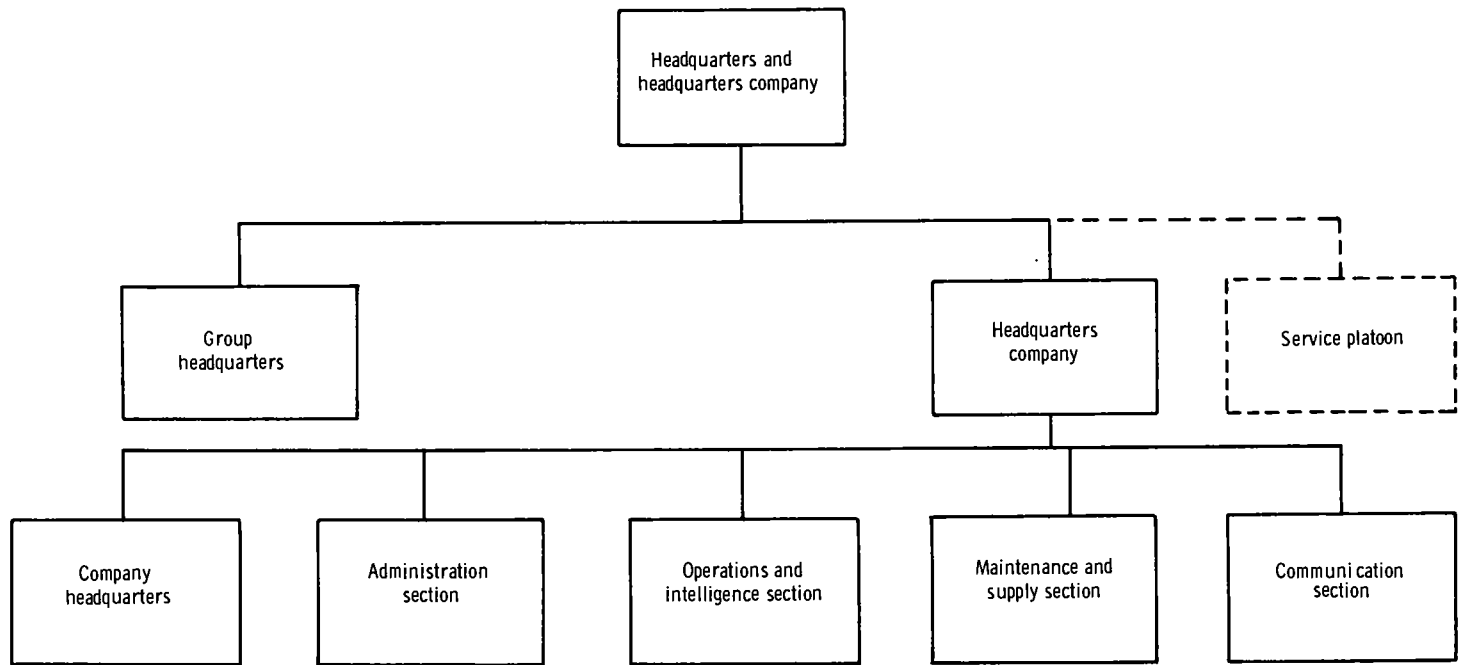

Figure 12. Headquarters and headquarters company aviation group.

d. Limitations. The group is not adaptable to organization under the type B column of TOE 1-252. The headquarters and headquarters company, aviation group, is authorized only those aircraft and wheeled vehicles that are required for day-to-day operations. Because the unit does not have sufficient mobility for movement or displacement, aerial or vehicular transportation must be furnished when movement or displacement is directed. The headquarters and headquarters company is 65 percent mobile. The unit is air transportable by Air Force aircraft.

e. Operations.

(1) *General.* The aviation group is assigned to a transportation brigade within the field army support command. The aviation group allocates aircraft units and assigns missions to aviation battalions. Allocation of aircraft is based on the type of mission and the requirements established by higher headquarters. Aviation units are normally allocated in accordance with aircraft characteristics and most efficient employment. Allocations are based on priorities assigned by higher headquarters. The aviation group is capable of independent operations. However, where only token U.S. Forces are present and normal combat service support troops and area logistical support points are limited or nonexistent, additional support must be planned for and provided concurrently with the deployment of the group. The additional support includes the means to provide all classes of supply, water points, medical facilities, engineer support, and other services not readily available from indigenous sources. Elements of transport units may be employed in a combat support role under priorities established by or through the commander of the field army support command. When required, aircraft of the group are employed to supplement aeromedical evacuation in the field army area. The terminal transfer company, when attached to the

aviation group, loads and unloads aircraft, accomplishes documentation, and operates cargo segregation and transit storage facilities at Army air terminals in corps and field army rear areas.

- (2) *Group headquarters.* The group headquarters provides command, staff planning, and control of operations of assigned or attached aviation battalions. The group headquarters contains the group commander, executive officer, aviation medical officer, aviation safety officer, chaplain, adjutant (S-1), intelligence officer (S-2), operations officer (S-3), logistics officer (S-4), communications officer, and sergeant major.
- (3) *Headquarters company.*
- (a) *Company headquarters.* The company headquarters performs command, administrative, and unit supply functions for the company; provides mess facilities; and controls organizational surface transportation and vehicular maintenance. The company headquarters contains the company commander, first sergeant, mess steward, supply sergeant, motor sergeant, first cook, company clerk, cook, powerman, wheel vehicle mechanic, cook's helper, supply clerk, and wheel vehicle mechanic's helper.
- (b) *Administration section.* The administration section provides the administrative personnel for operation of the group headquarters. It acts on official correspondence, prepares outgoing administrative directives, and supervises the preparation and maintenance of records, rosters, and reports concerning personnel staff noncommissioned officer (NCO), chaplain's assistant, clerk typist, medical aidman, stenographer, and light truck driver.
- (c) *Operations and intelligence section.* The operations and intelligence section advises and assists the group commander and the staff on mat-

ters concerning intelligence and in planning, coordinating, and supervising the operations of attached units. The section provides the movements control and coordination capability required in the performance of the group's mission. It implements operational procedures and directives of higher headquarters in the employment of assigned and attached units. The operations and intelligence section contains the operations officer, air transport officer, helicopter pilot, intelligence sergeant, operations sergeant, assistant operations sergeant, chemical NCO, senior movement specialist, clerk typist, draftsman, movement specialist, and light truck driver.

- (d) *Maintenance and supply section.* The maintenance and supply section provides maintenance and supply services for the group headquarters and headquarters company. This section provides officers and enlisted personnel to assist the group commander and staff in maintenance and logistical requirements for the group and its subordinate units. The maintenance and supply section contains the aircraft maintenance officer, assistant S-4 officer, food adviser, aircraft maintenance sergeant, supply sergeant, food service supervisor, assistant supply sergeant, aircraft mainte-

nance inspectors, clerk typist, crew chief, and light truck driver.

- (e) *Communication section.* The communication section installs and operates the required communication facilities (figs. 13 and 14) for the headquarters and provides the necessary control and supervision of communication procedures of assigned and attached units. The communication section contains the communications chief, radioteletypewriter team chief, radio mechanic, senior message clerk, radioteletypewriter operator, senior switchboard operator, teletypewriter operator, message clerk, and switchboard operator.

f. *Command Relationships.* Command relationships between the aviation group and its subordinate battalions are less restrictive than those in the conventional military chain of command. The position of the subordinate headquarters in the performance of the transportation support mission providing direct transport aircraft support to specified commands allows direct submission of requirements by the supported unit to the battalion. The group headquarters primary interest in support concerns information on aircraft (helicopter and fixed wing) availability as affected by such commitments. This information provides the group headquarters with current data necessary to planning group operations, both routine and emergency. The group headquarters maintains constant liaison with the transportation brigade, particularly the plans and operation section.

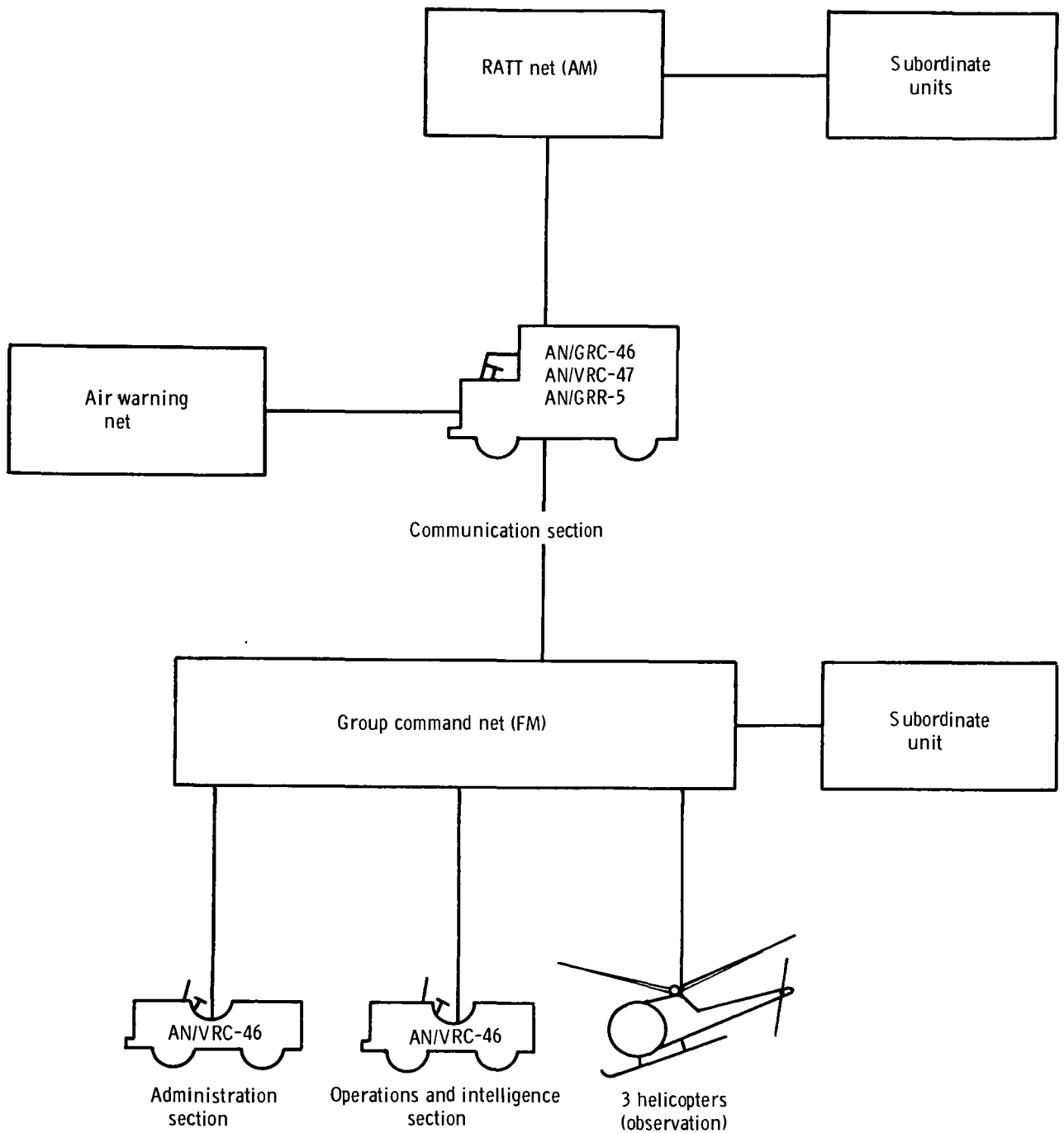
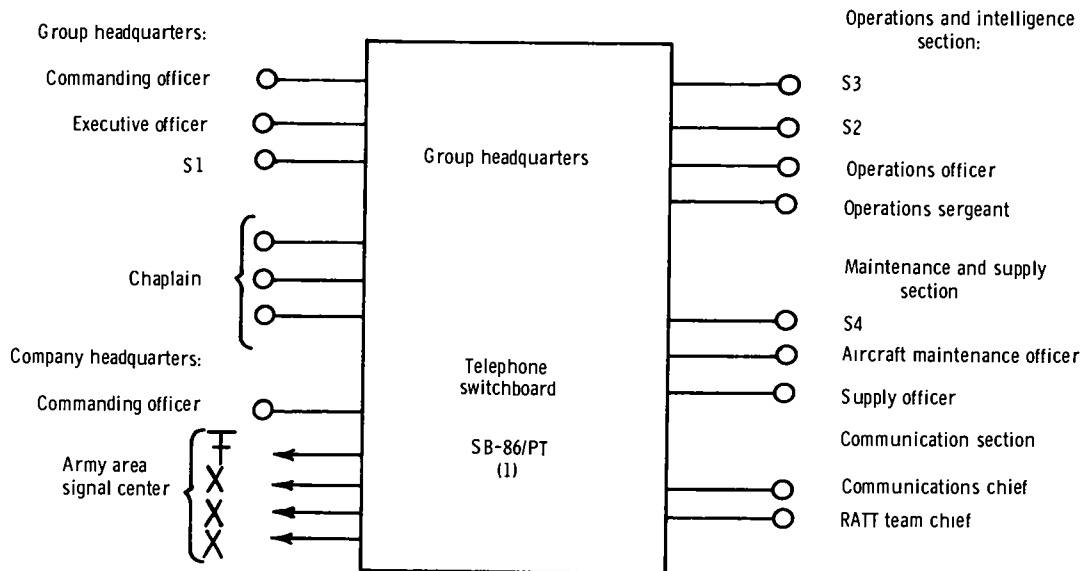

Figure 18. Radio communication net, aviation group.



LEGEND

- Subscriber telephone set
- ⊥ Teletypewriter
- X Telephone circuit to army signal center

Figure 14. Wire communication net, aviation group.

CHAPTER 3

TRANSPORT AVIATION SUPPORT OPERATIONS

12. General

The extension of the combat zone resulting from modern developments in weaponry and the possible use of nuclear weapons, which has brought about dispersion of combat and supporting units, has placed a high premium on effective military transportation support. In planning this support for the field army, transport aircraft are carefully allocated by type and amount to the levels of command where they may be used most effectively. Transport aviation support operations are developed to provide logistical airlift for movement of supplies and personnel during all phases of ground operation.

13. Offensive Operations

a. Advance to Contact. The advance-to-contact maneuver is used to gain contact or to reestablish contact with the enemy. It is usually conducted on a broad front and is characterized by decentralized control and piecemeal commitment of forces (FMs 7-20 and 57-35). Aviation units may be employed to support a divisional advance-to-contact operation by providing the following:

- (1) Airlift for airmobile forces conducting operations to seize key terrain essential to uninterrupted advance.
- (2) Immediately responsive airlift for airmobile reserve forces.
- (3) Augmentation of Army Medical Service aeromedical evacuation elements.

b. Penetration. Penetration seeks to break through the enemy's defensive position, widen the gap created, and destroy the continuity of his position. The divided enemy forces are then destroyed, and mobile forces exploit the

enemy rear areas. Aviation units may be employed to support divisional penetration by providing the following:

- (1) Airlift for airmobile forces conducting operations to seize limited objectives, to seal off approach routes of enemy reserves, and to seize critical terrain on the flanks of the penetration.
- (2) Aircraft to augment communications and control, especially during multiple penetration attacks.
- (3) Aerial movement of reserves to exploit success.
- (4) Aerial delivery of critical items to forces engaged in penetration.
- (5) Support for containment of bypassed enemy forces by aerial movement of troops.
- (6) Assistance for partisan forces, as directed, such as transportation of their leaders, distribution of supplies, and dissemination of instructions.

c. Envelopment. In envelopment, the main attack is directed against the flank or rear of the initial disposition of the enemy's forces and toward an objective behind his frontlines. Usually a secondary attack is directed against the enemy's front. Aviation units may be employed to support divisional envelopment by—

- (1) Delivering long-range paradrop patrols along the enemy's flank and along routes to be used by the enveloping force.
- (2) Providing air mobility for forces.
- (3) Conducting deception missions as directed.
- (4) Providing aircraft to augment communications and command control.

d. Infiltration. Infiltration is the movement of personnel and vehicles, singly or in small groups, at extended and irregular intervals. This movement is used when maximum secrecy and deception are desired. It provides the best possible protection from enemy air observation and attack but is difficult to control. Aviation units may be employed to support divisional infiltration by—

- (1) Airlifting part or all of the infiltrating force.
- (2) Conducting deception missions as directed.
- (3) Airdropping equipment and supplies to elements behind enemy lines.

e. Exploitation and Pursuit. Exploitation is the phase of offensive action, usually following a successful penetration or envelopment, characterized by rapid advances against lessening resistance. Its purpose may be to take an objective deep in the enemy rear area or to pursue a retreating enemy force. Pursuit is an offensive action against a retreating enemy force; it may consist entirely of direct pressure, or it may be a combination of direct pressure and encircling movement. Aviation units may be used to support divisional exploitation and pursuit operations by—

- (1) Airlifting supplies that are rapidly consumed (especially class III).
- (2) Providing aerial movement of troops and equipment to key positions on the enemy's flank or rear.
- (3) Providing aircraft for air mobility of forces to seize objectives in the enemy rear area, to cut lines of communication, to block escape routes, and to envelop the enemy rear guard, thereby promoting the advance of friendly forces.

14. Defensive Operations

a. Mobile Defense. In mobile defense most of the defending force is held as a striking force, with the remainder manning the forward defense positions. The defender seeks to engage the enemy in decisive action at a time and place of the defender's choosing, relying principally on vigorous and bold offensive action to destroy the enemy in tactical locations most favorable to the defender. De-

struction of the enemy is not limited to the area being defended. Mobile defense forces consists of security forces, fixing forces, and a strong reserve.

- (1) *Security forces.* A security force is a body of detachment of troops which provides security for a larger force by observation, reconnaissance, attack, or defense. Aviation units may be used to support security forces by providing—
 - (a) Aircraft to the covering force for the airlift of supplies and for augmentation of aeromedical evacuation elements.
 - (b) Airdrop of forces to establish combat outposts, observation posts, and patrols.
- (2) *Fixing forces.* Aviation units assist fixing forces in detecting impending enemy attacks; delaying, disorganizing, and inflicting damage on the enemy; and canalizing the enemy into areas for suitable counterattack. Aviation units provide support for—
 - (a) Airlift of troops and supplies.
 - (b) Augmentation of aeromedical evacuation elements.
 - (c) Aerial radiological survey and inspection of camouflage.
- (3) *Reserve.* The reserve or striking force is kept to the rear or withheld from action at the beginning of an engagement to be available for a decisive movement. Aviation units support the reserve force by providing on a priority basis—
 - (a) Airlift for commanders and staff officers during planning of counterattacks.
 - (b) Airlift of troops to expedite counterattack or to place the forces in a more advantageous position.

b. Area Defense. Area defense is designed to retain specific terrain for an indefinite period of time with forces deployed to repulse the attacker. The area defense force consists of security forces, forward defensive forces, and a reserve force. The functions of the reserve are to block and destroy the enemy, elim-

inate penetrations, or reinforce threatened areas. Aviation units may be used to support divisional area defense operations in much the same manner as in mobile defense (*a* above). The major difference is that forward defensive forces are usually closer together and require less aircraft support.

c. Special Defensive Considerations. There is a constant threat of enemy armor penetration, airborne assault, guerrilla action, or infiltration of enemy forces within divisional areas. Aviation units may effectively assist in countering these threats.

- (1) *Defense against armor penetration.* Armed aerial vehicles are particularly valuable where expeditious counteraction is necessary to prevent further penetration by enemy armor. Aviation units can assist by providing aerial resupply to air cavalry units.
- (2) *Defense against airborne assault.* A key defense against airborne attack is the use of highly mobile responsive reserves. Aviation units may be used to rapidly transport reserves to areas where they can counter airborne assaults.
- (3) *Defense against guerrilla action.* Transport aircraft may be used in defense against guerrilla operations by providing superior mobility in the air movement of troops, equipment, and supplies.
- (4) *Defense against infiltration forces.* Transport aircraft may be employed for reconnaissance missions over routes that are likely to be used for infiltration. Where infiltration has been successful, transport aviation units may be used for rapid transport of forces to counter the infiltrating groups.

15. Retrograde Operations

a. Withdrawal. In a withdrawal, all or part of a deployed force disengages from the enemy; however, contact is maintained to prevent rapid advance of the enemy. Withdrawals should preferably be made at night. Aviation units may be employed to support divisional withdrawal operations by—

- (1) Conducting deceptive measures.

- (2) Airlifting combat personnel as security forces and airdropping patrols.
- (3) Providing augmentation of aeromedical evacuation elements.

b. Retirement. A retirement is a withdrawal without pressure from the enemy. Aviation units support a retiring force much as they are used in an advance to contact (para 13). When the retiring force moves to the rear in multiple columns, air landed patrols maintain radio contact between the columns. Security elements closest to the enemy, such as rear and flank guards, have the highest priority for movement by aviation units. When there are sufficient aircraft, they may move major elements of the retiring force to the rear to gain distance from the enemy.

16. Counterinsurgency Operations

a. Civic Action Program. The civic action program by the military forces of a nation may be on a level as small as an individual teaching his particular technical skill to another in order to help him solve a problem or to better his condition. Or, it may be as large as the organization and functioning of a duly authorized quasi-military organization for opening up and settling remote areas. Aviation units may be employed to support civic action by—

- (1) Transporting civilian specialist teams (for example, medical, engineer, agriculture, and educational) to isolated areas requiring their services.
- (2) Airlifting emergency supplies to isolated areas.
- (3) Transporting key governmental political figures to remote or isolated areas for morale purposes.
- (4) Augmenting Army Medical Service aeromedical evacuation elements.
- (5) Disseminating propaganda by leaflet drop and aerial loudspeaker operations.
- (6) Improving civilian health and sanitation by delivering aerial spray against insects.
- (7) Delivering governmental intelligence agents.

b. Counter guerrilla Operations. Aviation units are important factor in counter guerrilla operations. To provide integrity of command,

counterguerrilla missions should be assigned by unit (platoon, company, or battalion). To be successful, counterguerrilla forces must have superior mobility, reliable intelligence, and effective communications; soldiers must be well trained; and leadership must be aggressive. Aviation units may be used in support of counterguerrilla operations as indicated below:

- (1) *Populace control.* Populace control measures must be implemented to prevent guerrillas from receiving the active and passive support of the people. Aviation units may support this control by—
 - (a) Moving troops or police to block off sections of roads or trails during search operations.
 - (b) Moving supplies and personnel during resettlement.
 - (c) Moving police or troops in surprise operations to seal off and search remote villages and towns.
 - (d) Spraying tear gas during riots.
- (2) *Isolation of guerrillas.* To help isolate guerrillas from support from outside the country, aviation units may be used to—
 - (a) Move combat units in pursuit of groups that have crossed borders or have moved inland from the sea.
 - (b) Position and supply ground observation posts and patrols.
- (3) *Psychological operations.* Aviation units may support psychological operations by—
 - (a) Disseminating leaflets.
 - (b) Broadcasting propaganda messages from aerial loudspeakers.
 - (c) Moving different types of equipment to different areas for propaganda purposes.
- (4) *Military tactical operations.* Counterguerrilla tactical operations include establishing security of villages, key installations, and convoys; patrolling; and conducting raids and encirclements. Aviation units may support tactical operations by—
 - (a) Moving troops, police, or guards to villages or installations under guerrilla attack.

- (b) Moving supplies and equipment as necessary.
- (c) Transporting a standby reaction force in the event of an ambush.
- (d) Positioning patrols deep in difficult terrain.
- (e) Providing transportation for withdrawal of patrols.

17. CBR Operations

a. Radiological Survey. Aerial radiological surveys are planned by the chemical officer with the G2 and are coordinated with the Army aviation representative. The Army aviation representative makes a checkpoint overlay of the unit area of responsibility. This overlay should be made at division, corps, army, and logistical command levels. Checkpoints should be from 1 to 2 miles apart and easily recognizable 100 feet above the terrain. Aviation may be used for transporting radiological survey teams and radiological equipment as required.

b. Evacuation. Medical elements are moved into the objective area to establish a system of emergency treatment and evacuation. Through augmentation, aviation units may support aerial ambulance units in order to meet peak casualty requirements and to move patients on a scheduled basis.

c. Movement of Nuclear Warheads. Nuclear warhead delivery units normally provide organic transportation for the movement of nuclear munitions forward of the designated special ammunition supply point. Aviation units may be used for transporting these munitions as required. Clearances may have to be obtained for the use of certain routes. When aviation units are employed, coordination is necessary before live ammunition and atomic demolition munitions can be carried (FM 5-26). The handling of this type of cargo (explosives, ammunition, dangerous cargoes) must be carried out with the prescribed precautions (see app VI (STANAG 3327)).

18. Mountain, Jungle, Arctic, and Desert Operations

a. Mountain. Aviation units may support mountain operations in troop movements, resupply, and other transportation missions. The principal tactical advantages of aircraft em-

ployment in mountain operations are rapidity of movement, surprise, flexibility, and operational depth. Detailed information on mountain operations is contained in FM 31-72.

b. Jungle. Aviation units may support jungle operations in troop movement, resupply, evacuation, and other transport missions. Aviation units provide the commander with a significantly greater capability for mobility and maneuverability and for command control and communications. Detailed information on jungle operations is contained in FM 31-30.

c. Arctic. Aviation units may be employed in many activities which ground troops would

find difficult in the arctic region, such as transportation of personnel and supplies and evacuation. Aviation units can support operations which cannot be supported by surface transportation. Detailed information on operations in arctic regions is contained in FM 31-70 and FM 31-71.

d. Desert. Aviation units may support desert operations in troop movement, resupply, evacuation, and other transportation missions. The freedom of movement afforded by the desert increases the depth of objectives and the frontages of units. Detailed information on operations in desert regions is contained in FM 31-25.

CHAPTER 4

TRAINING

19. Responsibilities

a. General. Conducting Army training programs, Army training tests, and training in allied subjects is a command responsibility. Each unit commander is responsible for training his unit to perform its mission. Cross training, unit, section, individual, and specialists training are conducted continuously and concurrently with normal operations. FMs 21-5 and 21-6 should be used as guides for the principles and techniques of training.

b. Aviation Group. The aviation group establishes master training schedules, technical training programs, and unit schools. It actively supervises the training of all units in the group and coordinates with the transportation brigade to obtain required support. Suitable training areas are designated for subordinate units. The group headquarters effects the necessary planning, coordination, and liaison to provide combined training exercises in conjunction with tactical units and Army aviation operating units.

20. Officers and Warrant Officers

a. Aviation units contain a greater proportion of officers and warrant officers than non-aviation units. In addition to being rated aviators, aviation officers must be equally proficient as ground officers. Therefore, aviators assigned to aviation units require training in both ground and aviation tactics. This enables aviators to understand the mission of the supported unit and to be more efficient in providing the required support.

b. Even though the assigned duty is primarily limited to flying, the aviator should keep current on new tactics and techniques. This may be accomplished through the unit's training program. Extensive training is necessary

to keep the aviator proficient in both tactical and nontactical flying. Training must include instruction in the latest flight regulations and ground subjects, with cross training in all functions of the unit to which he is assigned.

21. Enlisted Personnel

a. General. Basic combat training for enlisted men is contained in ATP 21-114. The objective of basic combat training is to produce a physically conditioned soldier indoctrinated and drilled in the fundamentals of soldiering and familiar with basic military tactics. This training is important in aviation units, but the individual must also become a specialist in his MOS in order to perform his assigned duties. He must receive on-the-job training to develop his MOS proficiency, and he must maintain his basic soldiering ability.

b. Specialist MOS Training. The training of enlisted specialists, particularly in communications, vehicle and aircraft maintenance, avionics, and air traffic regulation and identification, is one of the aviation commander's most important training responsibilities. Specialist training, the foundation of which is laid during the advanced individual phase of the enlisted man's training must be carefully planned and closely supervised. Specialist training is received at service schools, and unit schools, and through on-the-job training.

22. Unit Training

Unit training consists of training in all phases of combat operations. During unit training, the unit spends much time in the field operating under conditions of simulated combat. Emphasis is placed on leadership, administrative efficiency, unit integrity, team work, mo-

rally, and supply economy. Unit training consists of two phases: basic unit and advanced unit training.

a. Basic Unit Training Phase. The objective of the basic unit training phase is to develop effective and coordinated sections and teams from individuals who have learned particular skills and techniques during the advanced individual training phase. These skills and techniques are progressively developed to meet requirements of subordinate elements, with the view of producing an efficiently functioning unit.

b. Advanced Unit Training Phase. The advanced unit training phase is designed to implement training previously received and to mold the subordinate elements of the unit into a smoothly functioning unit. The maximum possible unit training time should be spent in bivouacs conducted under a simulated tactical situation. Particular attention should be given to—

- (1) Dispersion.
- (2) Concealment from enemy observation.
- (3) Local security, including means of combating insurgents and infiltrators.
- (4) CBR protective measures.
- (5) Individual and unit protective measures applicable to modern nuclear warfare.
- (6) Aircraft marshalling (STANAG 3117, app VII).

23. Supported Unit Training

The aviation group establishes planning, coordination, and liaison to arrange combined training exercises in conjunction with combat units and transport aviation units. This combined training promotes maximum coordination and understanding between Army aviation units and supported units. Tactical units desiring to participate in combined training exercises make their requests through G3 channels to the aviation group.

a. Training in airmobile operations should be integrated throughout the unit training phase of both Army aviation units and the supported unit.

b. Participating personnel receive instruction in the following:

- (1) Conduct of airmobile operations.
- (2) Indoctrination in psychological problems inherent in airmobile operations.
- (3) Familiarization with loading, lashing, and unloading of the type of aircraft to be employed.
- (4) Assembly techniques.
- (5) Escape and evasion tactics.
- (6) Safety, emergency, and signaling procedures for air transport operations (STANAG 3465, app VIII).

c. Rehearsals are conducted before actual operations.

APPENDIX I

REFERENCES

1. Army Regulations

| | |
|--------------|--|
| AR 59-series | Air Transportation |
| AR 95-series | Aviation |
| AR 96-series | Air Transportation |
| AR 320-5 | Dictionary of U.S. Army Terms |
| AR 320-50 | Authorized Abbreviations and Brevity Codes |
| AR 350-1 | Army Training |
| AR 385-10 | Army Safety Program |

2. Field Manuals

| | |
|--------------|---|
| FM 1-5 | Army Aviation Organizations and Employment |
| FM 1-10 | Army Aviation Organizational Aircraft Maintenance and Supply |
| FM 1-60 | Army Aviation Air Traffic Operations—Tactical |
| FM 1-100 | Army Aviation |
| (S) FM 5-26 | Employment of Atomic Demolitions (ADM) (U) |
| FM 7-20 | Infantry, Airborne Infantry, and Mechanized Infantry Battalions |
| FM 11-21 | Tactical Signal Communication Systems, Army, Corps, and Division |
| FM 21-5 | Military Training Management |
| FM 21-6 | Techniques of Military Instruction |
| FM 21-40 | Small Unit Procedures in Chemical, Biological, and Radiological (CBR) Operations |
| FM 31-15 | Operations Against Irregular Forces |
| FM 31-25 | Desert Operations |
| FM 31-30 | Jungle Operations |
| FM 31-70 | Basic Cold Weather Manual |
| FM 31-71 | Northern Operations |
| FM 31-72 | Mountain Operations |
| FM 41-10 | Civil Affairs Operations |
| FM 54-3 | Fascon (when published) |
| FM 54-4 | The Support Brigade (when published) |
| FM 55-15 | Transportation Reference Data |
| FM 55-56 | Transportation Terminal Transfer Company |
| FM 57-10 | Army Forces in Joint Airborne Operations |
| FM 57-35 | Airmobile Operations |
| (S) FM 100-1 | Doctrinal Guidance (U) |
| FM 100-5 | Field Service Regulations—Operations |
| FM 100-10 | Field Service Regulations; Administration |
| FM 101-5 | Staff Officers Field Manual, Staff Organization and Procedure |
| FM 101-10 | Staff Officers Field Manual; Organizational, Technical, and Logistical Data |

3. Technical Manuals

- TM 1-series Aviation
- TM 5-330 Planning, Site Selection, and Design of Roads, Airfields, and Heliports in
 the Theater of Operations
- TM 57-210 Air Movement of Troops and Equipment

4. Technical Bulletins

- AVN-series Aviation

5. Tables of Organization and Equipment

- TOE 1-252 Headquarters and Headquarters Company, Aviation Group
- TOE 1-256 Headquarters and Headquarters Detachment, Aviation Battalion
- TOE 1-257 Aviation Fixed Wing Airplane Company
- TOE 1-258 Transport Medium Helicopter Company

6. Army Training Programs

- ATP 21-114 Male Military Personnel Without Prior Service

7. Supply Bulletins

- SB 1-1 Army Aircraft Flying Hour Factors and Forecast

APPENDIX II

METHOD FOR DETERMINING AIRCRAFT REQUIREMENTS

1. General

a. To determine the number of aircraft required for a mission, commanders and staff officers must be familiar with the types and characteristics of the aircraft available for the move. The following factors must be considered:

- (1) Load-carrying characteristics — dimensions and location of the cargo door and dimensions of the cargo compartment.
- (2) Allowable cargo load—provided by the transport aircraft unit commander based on technical considerations.
- (3) Number of men and amount of equipment (by type, weight, and dimensions) and supplies (by weight) to be transported.

b. With this information, the aircraft requirements can be determined in three ways: by the weight method, the type load method, or the space method.

2. Weight Method

a. In the weight method, the total weight to be moved is the determining factor. This method is not accurate enough to be used in computing requirements for units that must transport major items of equipment and maintain tactical integrity.

b. A sample application of the weight method follows:

Weight to be transported, 73,800 pounds
Allowable cargo load, each aircraft, 6,000 pounds

$$\frac{73,800}{6,000} = 12.3 \text{ or } 13 \text{ aircraft required}$$

3. Type Load Method

The type load method is based on typical combinations of men and cargo within the aircraft load limits. It is particularly useful for determining the number of aircraft required for small units. Four sample type loads follow:

Type I:

2¼-ton trucks

3 men

Type II:

1¼-ton truck

2¼-ton trailers (loaded)

4 men

Type III:

1¼-ton truck

1¼-ton trailer (loaded)

9 men

Type IV:

1¼-ton truck

1 106-mm rifle (truck-mounted)

2 rounds 106-mm ammunition

10 men

4. Space Method

a. The space method combines the best features of the weight and type load methods. This is the most desirable method of computing aircraft requirements for most units since the number of spaces required for personnel, vehicles, weapons, and individual items of equipment will not change for each operation. Thus the majority of the computations remain constant and the overall planning time is shortened.

b. The weight of a fully combat equipped soldier is used as a denominator to convert the

weight of major items of equipment and accompanying supplies into a common factor: a space. One space equals the weight of a fully equipped soldier (considered to be 240 pounds; the soldier's weight plus the weight of hand-carried supplies and equipment to include crew-served weapons up to, but not including, the 106-mm rifle and the 4.2-inch mortar).

| <i>Item</i> | <i>Weight each</i> | <i>Spaces each</i> | <i>Total spaces</i> |
|-----------------|--------------------|---------------------------------|----------------------|
| 10 ¼-ton trucks | 2,625 | $\frac{2,625}{240} = 10.9 = 11$ | $10 \times 11 = 110$ |

- (2) Convert additional assault supplies into spaces by dividing their total weight in pounds by 240. For example—

$$\frac{5,800}{240} = 24.16 = 24.5 \text{ spaces required.}$$

Note. When converting transported weight to spaces, consider only whole or half-spaces. Carry fractions to the next higher half-space. (10.1 = 10.5, 11.6 = 12)

- (3) To determine the number of spaces that each aircraft can provide, divide the allowable cargo load in pounds by 240. For example—

- c. Sample application of the space method:
 (1) Convert major items of equipment into spaces by dividing the weight of each item of equipment by 240. If two or more items of the same type are to be transported, multiply the spaces required for a single item by the number of items. For example—

$$\frac{5,850}{240} = 24.3 = 24 \text{ spaces}$$

Note. In converting allowable cargo loads to spaces, consider only whole or half-spaces. Fractions will be reduced to the next lower half-space. (22.8 = 22.5, 24.4 = 24)

- (4) To determine the number of aircraft required, divide the total spaces (2,467 spaces required) by the number of spaces for a single aircraft (24 spaces per aircraft).

$$\frac{2,467}{24} = 102.7 = 103 \text{ aircraft required.}$$

APPENDIX III

ASSEMBLY TECHNIQUES

I. General

This appendix outlines the techniques and aids suitable for conducting an assembly in air-landed operations when the assembly of units is deemed necessary.

2. Assembly Techniques and Aids

a. Assembly plans are based on the use of one of the following techniques:

- (1) Assembly by a subordinate unit independent of other subordinate units (fig. 15).
- (2) Assembly by subordinate units in conjunction with other units (fig. 16).

b. A thorough briefing on the assembly plan is conducted by all units. As time and facilities permit, the briefing should be augmented by the use of maps, charts, aerial photographs, and sandtables.

c. Assembly aids used at landing sites and strips may be visual, audible, or electronic.

- (1) *Visual assembly aids.* Panels, flags,

smoke, and pyrotechnics are used in a variety of colors. Visual aids on the periphery of the landing zone indicate the location of assembly areas for subordinate units.

- (2) *Audible assembly aids.* Audible aids include whistles, cowbells, bugles, and other devices that make a distinctive sound that can be heard above the sound of battle.
- (3) *Electronic assembly aids.* Electronic aids include radio and radio homing devices. The conventional ground radio can assist in guiding troops to a given location when properly modified with directional homing antenna.

d. Normally, the same considerations apply for night assembly as for day. However, briefings are more detailed, aircraft (helicopter and fixed wing) landing direction is emphasized for directional orientation, light discipline is carefully controlled, and more time is needed to establish assembly aids.

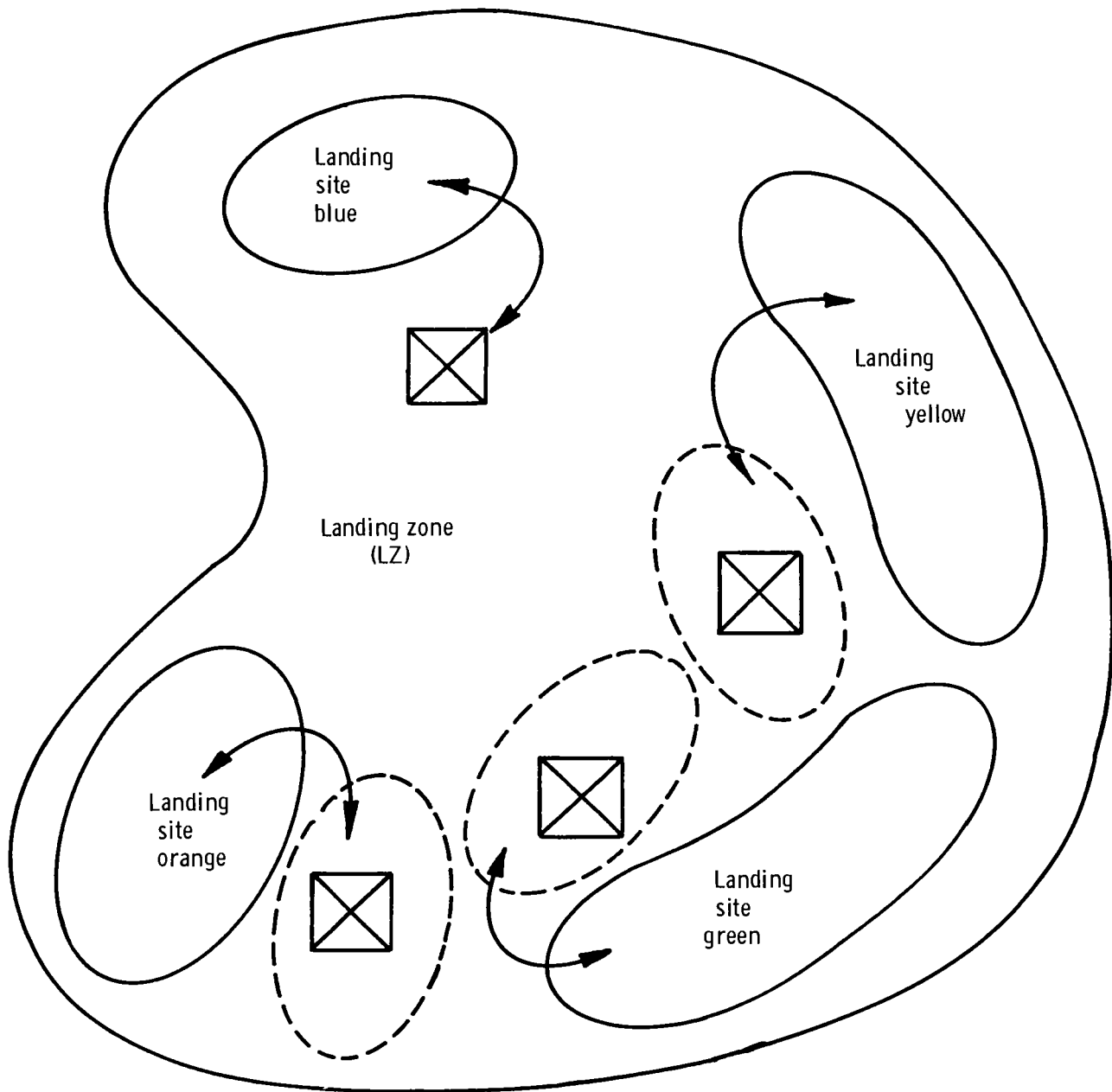

Figure 15. Independent assembly of subordinate units.

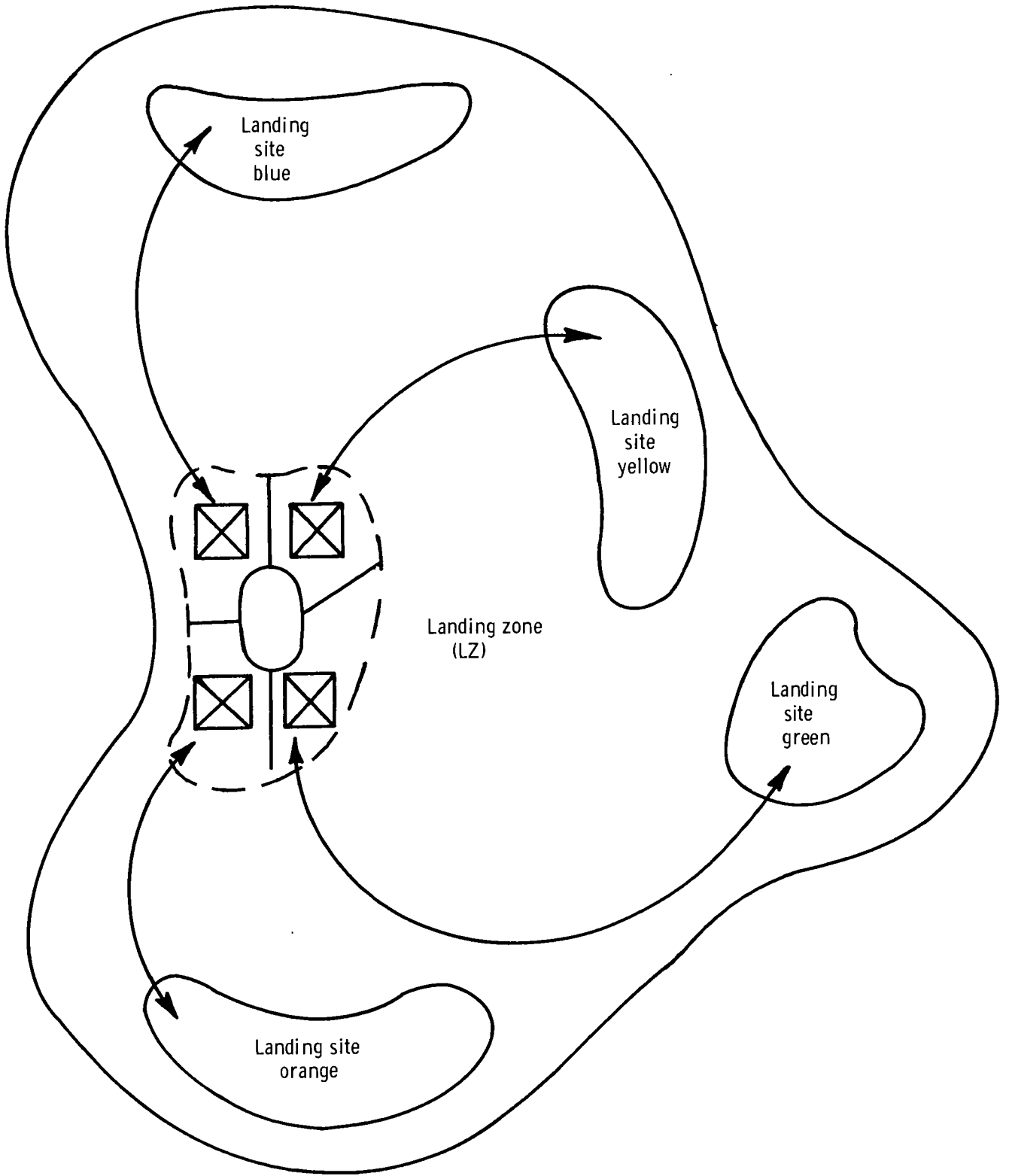

Figure 16. Assembly in conjunction with other subordinate units.

APPENDIX IV

AIRCRAFT LOADING AND MOVEMENT TABLES

1. General

Aircraft loading and movement tables facilitate planning. The tables may be modified as necessary to conform to the detail required in planning for a given mission.

2. Loading Table

The completed loading table reflects the number of personnel, amount of assault supplies, and major items of equipment to be loaded. From the completed table, aircraft requirements can be determined rapidly and accurately and the force can be easily organized into serials. A sample air loading table follows.

3. Movement Table

The completed movement table reflects aircraft (helicopter and fixed wing) requirements, takeoff and landing times, and number of serials. A sample air movement table follows.

AIR LOADING TABLE (SAMPLE)
(Classification)

Copy No. _____
Issuing unit _____
Place of issue _____
Date-time group _____
Message reference number _____

Annex F (Air Loading Table) to Operation Order _____

References: Maps, charts, etc.

Flight serial no. _____, Loading area _____, Station time _____

Loading zone _____

| Flight unit | Aviation unit | Transported unit | Chalk No. | Loaded with | Loading site | Landing site | Remarks |
|-------------|-------------------------|---|-----------|---------------------------------|--------------|--------------|---------|
| C-1 | 36th Helicopter Company | Co. C (-) Command Group, 1st Brigade, 87th Infantry | 1 | 10 men Co. C 10 men hq co | C-1 | C-1 | |
| | | | 2 | 12 men Co. C 2 106-mm rifles | C-1 | C-1 | |

Acknowledge
Distribution
Authentication

(Commanding Officer)

(Classification)

AIR MOVEMENT TABLE (SAMPLE)

(Classification)

Copy No. _____
 Issuing unit _____
 Place of issue _____
 Date-time group _____
 Message reference number _____

Annex D (Air Movement Table) to Operation Order _____

Reference: Maps, charts, etc.

| 1 | 2 | 3 | 4 | 5 | 6 | 7 | 8 | 9 | 10 | 11 | 12 |
|------------|----------------------------|----------------------------------|--------------------|--------------|--------------|---------------|---------------|---------------|--------------|--------------|---------|
| Serial No. | Transporting aviation unit | Transported unit | No. of helicopters | Loading area | Station area | Take-off time | Initial point | Release point | Landing zone | Landing time | Remarks |
| 1 | 36th Helicopter Company | Company B Reconnaissance Platoon | 16 | B | 0539 | 0544 | 0551 | 0559 | B | 0600 | |
| 2 | 26th Helicopter Company | Company A Assault Gun Platoon | 16 | A | 0544 | 0549 | 0556 | 0604 | A | 0605 | |
| 3 | 59th Helicopter Company | Company D | 12 | D | 0549 | 0554 | 0601 | 0609 | D | 0610 | |

Acknowledge
 Distribution
 Authentication

 (Commanding Officer)

APPENDIX V

LIAISON OFFICER'S GUIDE (SAMPLE)

1. General

When a unit is assigned an airlift mission, the commander will immediately establish liaison with the supported unit.

2. Planning sequence

The following information should be obtained in order to coordinate and execute a successful air operation:

- a. Supported unit.
- b. Contact officer.
 - (1) Location.
 - (2) Time to be contacted.
- c. Type of mission.
- d. Situation.
 - (1) Enemy.
 - (2) Friendly.
 - (3) Ground tactical plan of supported unit.
- e. Plan of execution.
 - (1) Time to report.
 - (2) Suggested routes.
 - (3) Flight altitude to be flown.
 - (4) Departure point, checkpoints, and release point.
 - (5) Control of flight.
 - (6) Spare aircraft allocated and procedures for employment.
- f. Loading area.
 - (1) Coordinates.
 - (2) Description.
 - (3) Marking.
 - (4) Ground control frequencies and call signs.
 - (5) Officer in charge.
 - (6) Loading Plan.
- g. Landing zone.
 - (1) Coordinates.
 - (2) Description.
 - (3) Marking.
 - (4) Ground control frequencies and call signs.
 - (5) Landing plan.
 - (6) Traffic pattern.
- h. Refueling facilities.
 - (1) Location.
 - (2) Capabilities, requirements, and procedures.
- i. Air (friendly and enemy).
- j. Artillery (friendly and enemy).
- k. Strong points.
 - (1) Antiaircraft.
 - (2) Troops.
 - (3) Armor.
- l. Alternate plan to cover:
 - (1) Weather abort.
 - (2) Mechanical abort.
 - (3) Loss of communications.
 - (4) Enemy action.
 - (5) Flight routes.
- m. Weather information and briefing.
- n. Mission debriefing.
- o. Rehearsals and training procedures.

APPENDIX VI
STANAG NO. 3327
AIR TRANSPORTATION OF DANGEROUS CARGO

NATO—UNCLASSIFIED

Original English/French Translation

STANAG NO. 3327

DETAILS OF AGREEMENT

AIR TRANSPORTATION OF DANGEROUS CARGO

1. Participants agree that the categorization and authorization for the transport by air of explosives, radioactive materials and other dangerous cargo (for example, corrosive, poisonous or highly inflammable materials) by each NATO nation will be acceptable by the other NATO nations as applicable for onward carriage by their own military aircraft during emergency or war.
2. Special restrictions and precautions in handling will be notified by the originating nation to the other nation (s) concerned at the time acceptance is sought.
3. Qualified escorts will be provided as required by the originating nation.
4. In the case of dangerous cargo being handed over from one nation to another for onward carriage without previous or accompanying instructions as to safety precautions to be observed during transport, the safety regulations of the nation accepting the cargo will apply.

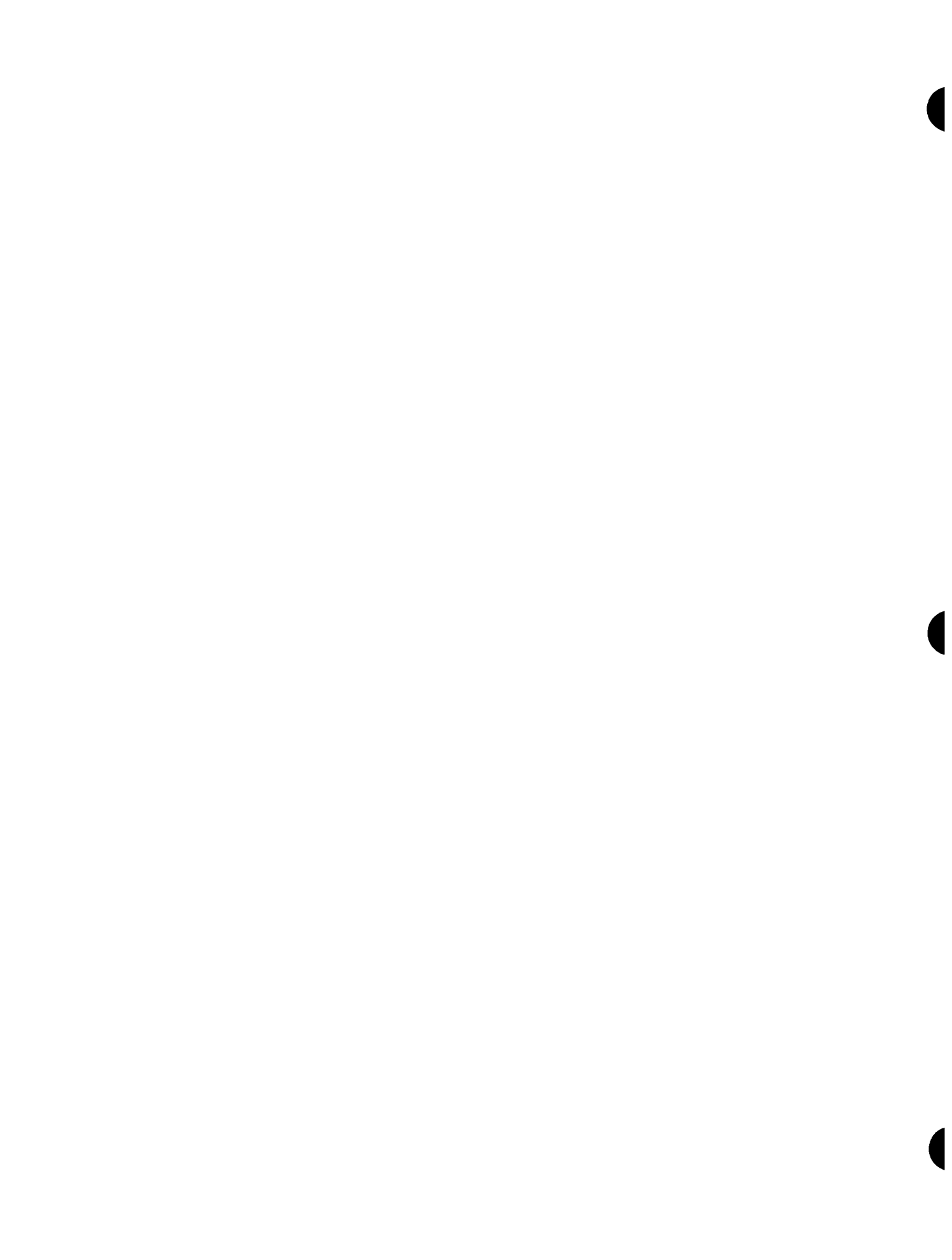

APPENDIX VII
STANAG NO. 3117
AIRCRAFT MARSHALLING

NATO—UNCLASSIFIED
AGREED ENGLISH/FRENCH TEXT STANAG NO. 3117
(Edition No. 2)

TERMS OF AGREEMENT
AIRCRAFT MARSHALLING

- * * * * *
5. RESERVATIONS
- a. To Ratification
- * * * * *
- (5) UNITED STATES: Part I, Signal 8: The present ICAO Signal will be used. Part II, Signal 8: This Signal will not be as the release load signal under Signal 3 can be used in winching operations.
- * * * * *

DETAILS OF AGREEMENTS
AIRCRAFT MARSHALLING

- Enclosures:
- I. Annex A—Marshalling Signals for All Aircraft.
 - II. Annex B—Additional Marshalling Signals for Hovering Aircraft.
 - III. Annex C—Additional Marshalling Signals for Naval Aircraft.
 - IV. Annex D—Distinctive garment to be worn by Aircraft Marshallers.
1. Participants agree that the aircraft marshalling signals attached at Annexes, A, B, C, & D will be used by all their NATO Forces.
 2. They agree that their aircraft marshallers will wear the distinctive garment as described with the exception that the distinctive garment will not be required for airfields, airstrips, helipads, and heliports used by tactical Army aircraft.

NOTE:

1. The signals to an aircraft on movement areas are designed for use by the marshaller facing the aircraft in a position:
 - a. for fixed wing aircraft, forward of the left wing tip within view of the pilot; and
 - b. for helicopters, where he can best be seen by the pilot.
2. For night operations, the wands should not be too bright and used in pairs of the same colour.
3. The signals listed below may be used by the pilot as appropriate, using the signal in a similar way to that indicated.

PART I

MARSHALLING SIGNALS FOR ALL AIRCRAFT

1. PROCEED TO NEXT MARSHALLER

Right or left arm down,
 other arm moved across the
 body and extended to indicate
 direction of next marshaller.

No equivalent ICAO signal

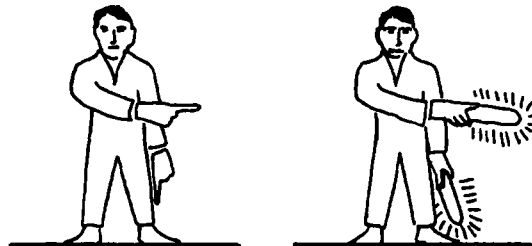

2. THIS MARSHALLER

Arms above head in vertical
 position with palms facing
 inward.

Conforms to ICAO signal
 "THIS BAY"

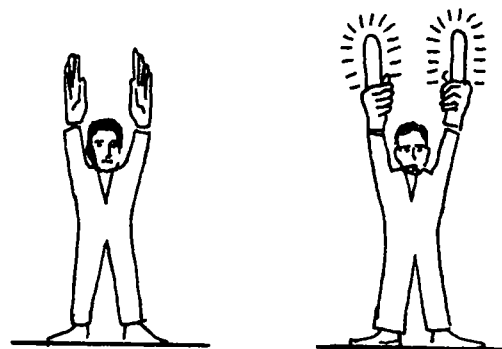

3. MOVE AHEAD

Arms a little aside, palms facing backwards and repeatedly moved upward-backward from shoulder height.

Conforms to ICAO signal

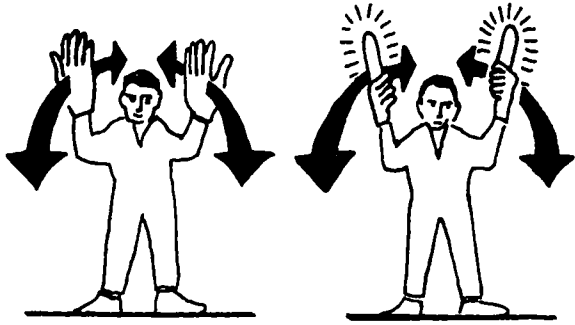

4. TURN

a. TURN TO PORT (LEFT)

Point right arm downward, left arm repeatedly moved upward-backward. Speed of arm movement indicating rate of turn.

Conforms to ICAO signal

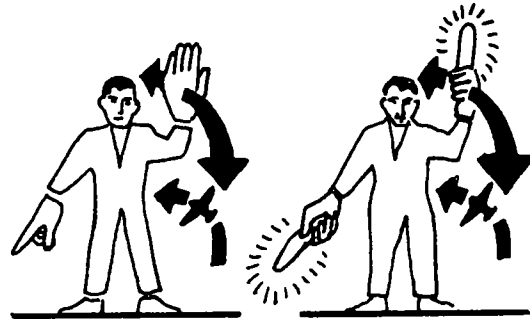

b. TURN TO STARBOARD (RIGHT)

Point left arm downward, right arm repeatedly moved upward-backward. Speed of arm movement indicating rate of turn.

Conforms to ICAO signal

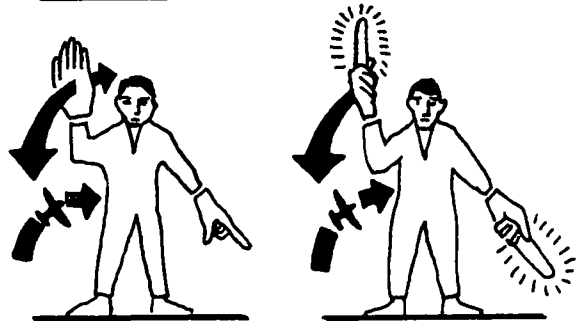

5. SLOW DOWN

Arms down with palms toward ground, then moved up and down several times.

Conforms to ICAO signal

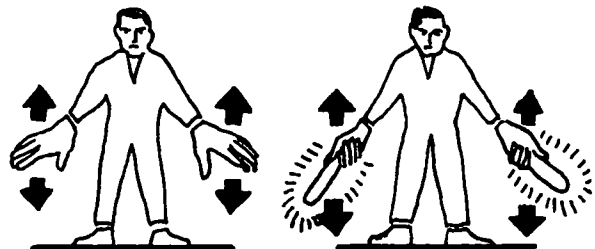

6. SLOW DOWN ENGINE(S) ON INDICATED SIDE

Arms down with palms toward ground, then either right or left arm waved up and down indicating that left or right side engines respectively should be slowed down.

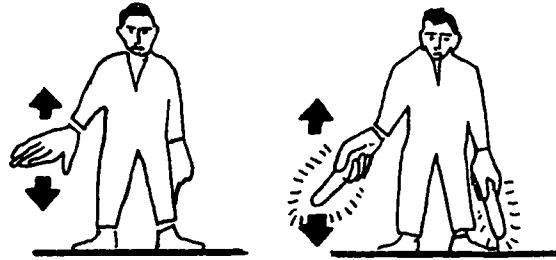

Conforms to ICAO signal

7. MOVE BACK

Arms by sides, palms facing forward, arms swept forward and upward repeatedly to shoulder height.

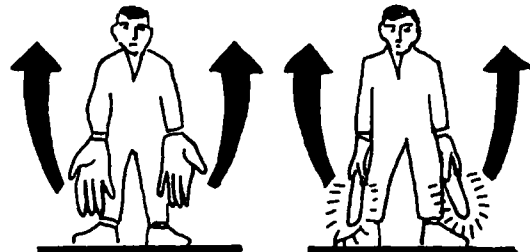

Conforms to ICAO signal

8. TURNS WHILE BACKING

a. TAIL TO PORT (LEFT)

Point right arm down, left arm by side, palm facing forward and swept forward and upward repeatedly to shoulder height.

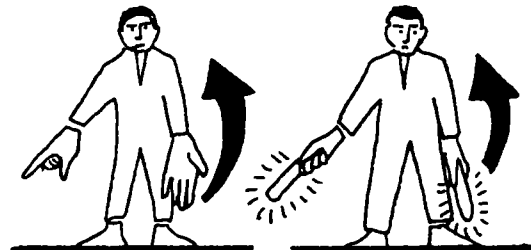

ICAO Signal

Point right arm down and left arm brought from overhead, vertical position to horizontal forward position, repeating left arm movement.

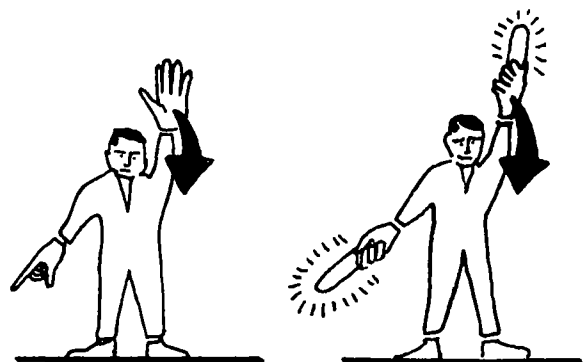

b. TAIL TO STARBOARD (RIGHT)

Point left arm down, right arm by side, palm facing forward and swept forward and upward repeatedly to shoulder height.

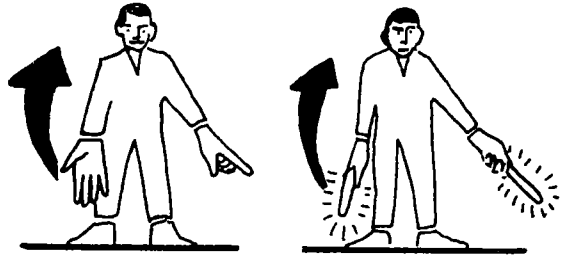

ICAO Signal

Point left arm down and right arm brought from overhead, vertical position to horizontal forward position, repeating right arm movement.

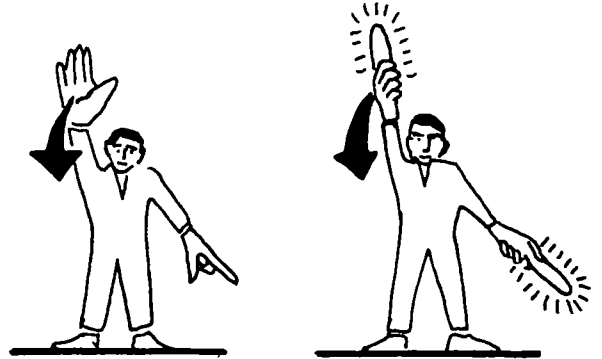

9. STOP

Arms repeatedly crossed above head (the rapidity of the arm movement should be related to the urgency of the stop, i.e. the faster the movement the quicker the stop).

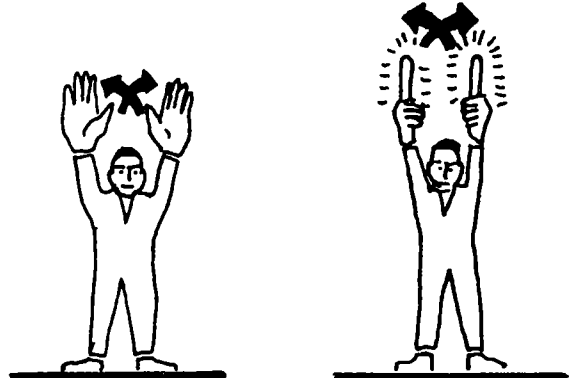

Conforms to ICAO signal

10. START ENGINE(S)
(START ROTOR(S))

Circular motion of right hand at head level with left arm pointing to engine (or rotor)

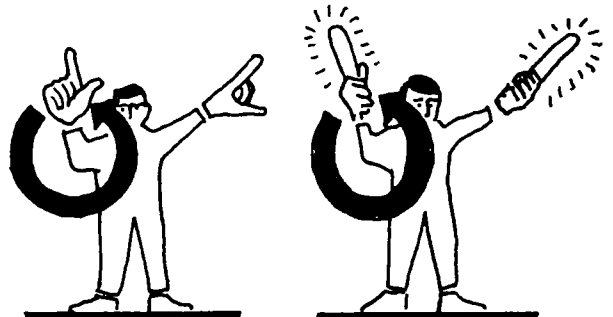

Conforms to ICAO signal

11. CUT ENGINE(S)

Either arm and hand level with shoulder, hand moving across throat, palm downward.

Conforms to ICAO signal

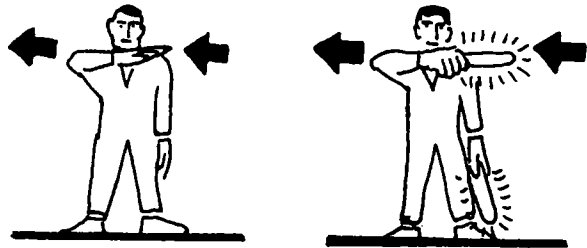

12. AUXILIARY POWER UNIT

a. CONNECTED

Hands above head, left fist partially clenched, right hand moved in direction of left hand with first two fingers extended and inserted into circle made by fingers of the left hand.

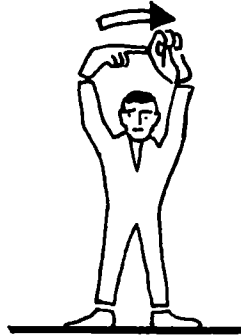

b. DISCONNECTED

Hands above head, left fist partially clenched, right hand moved away from left hand, withdrawing first two fingers from circle made by fingers of the left hand.

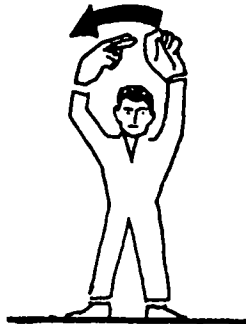

No ICAO signal

13. CHOCKS

a. INSERT CHOCKS

Arms down, fists closed, thumbs extended inwards swing arms from extended position inwards.

Conforms to ICAO signal

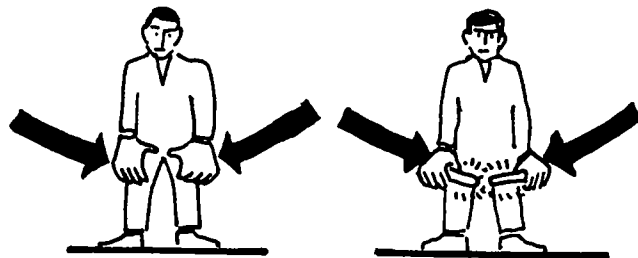

b. REMOVE CHOCKS

Arms down, fists closed, thumbs extended outwards swing arms outwards.

Conforms to ICAO signal

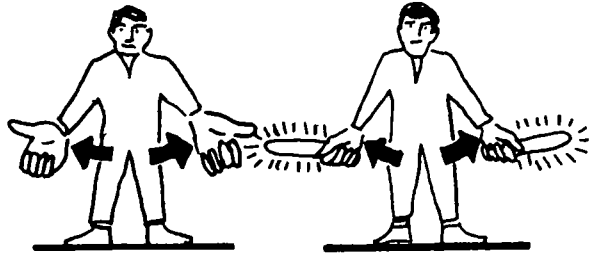

14. FLAPS

a. LOWER WING FLAPS

Hands in front, palms together horizontally then opened from the wrist alligator-mouth fashion.

No equivalent ICAO signal

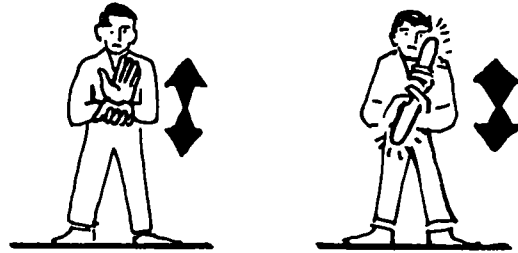

b. RAISE WING FLAPS

Hands in front, horizontally, with palms open from the wrists, then suddenly closed.

No equivalent ICAO signal

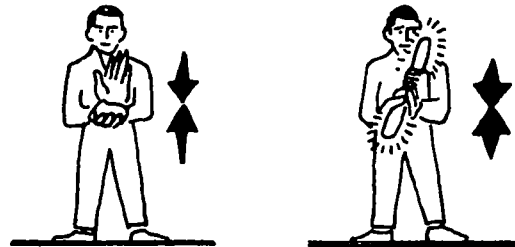

15. OPEN COWL FLAPS

Hands flat against sides of head, then opened by bringing thumbs outward and forward.

No equivalent ICAO signal

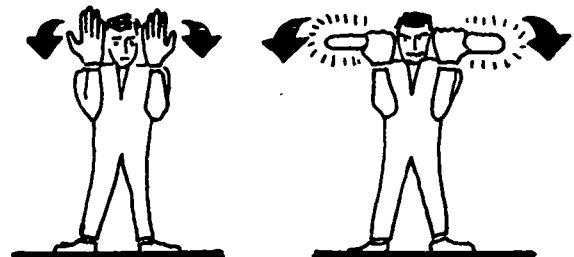

16. TAIL WHEEL

a. LOCK

Hands together overhead palms open from the wrists in a vertical V, then suddenly closed.

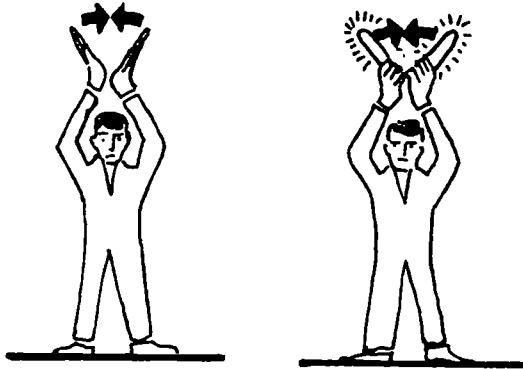

No equivalent ICAO signal

b. UNLOCK

Hands overhead, palms together then opened from the wrists to form a vertical V.

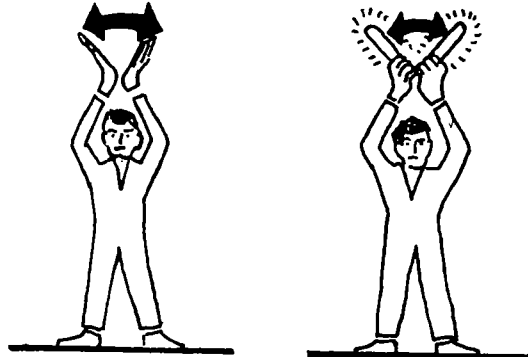

No equivalent ICAO signal

17. BOMB BAY

a. OPEN

Hand to be held with fingertips touching in front of the body, then swung down and outwards.

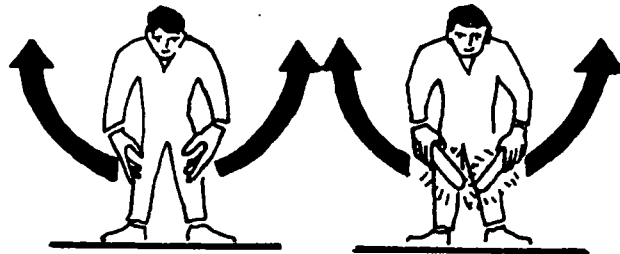

No equivalent ICAO signal

b. CLOSE

Arms to be extended, then swung downward and in until fingertips touch in front of the body with elbows bent at approximately 45 degrees.

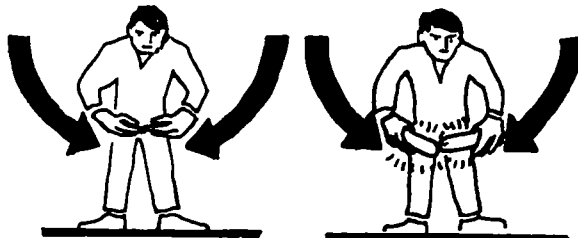

No equivalent ICAO signal

18. MARSHALLING FINISHED

Right arm raised with
elbow at shoulder
height with palm facing
forward.

No equivalent ICAO signal

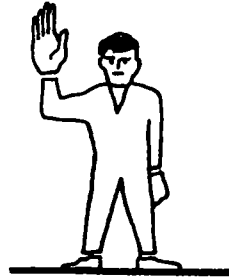

19. SIGNALS FOR GENERAL USE

a. AFFIRMATIVE SIGNAL

Hand raised, thumb up.

No equivalent ICAO signal

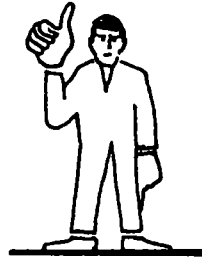

b. NEGATIVE SIGNAL

Hand raised, thumb down.

No equivalent ICAO signal

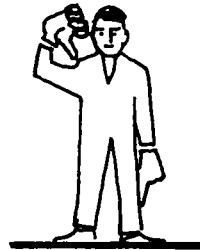

PART II

ADDITIONAL MARSHALLING SIGNALS
FOR HOVERING AIRCRAFT

1. VERTICAL MOVEMENT

a. MOVE UPWARDS

Arms extended horizontally sideways beckoning upwards, with palms turned up. Speed of movement indicates rate of ascent.

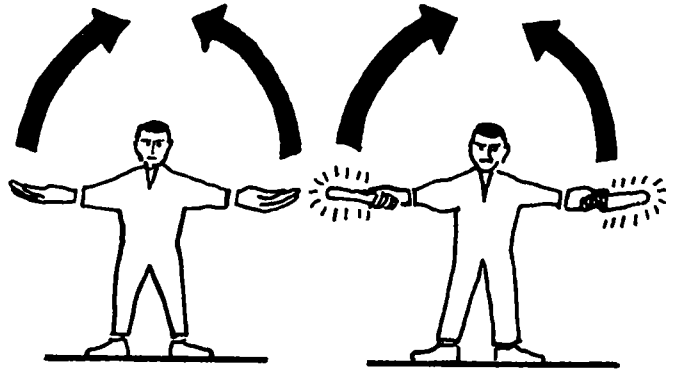

Conforms to ICAO signal

b. MOVE DOWNWARDS

Arms extended horizontally sideways beckoning downwards, with palms turned down. Speed of movement indicates rate of descent.

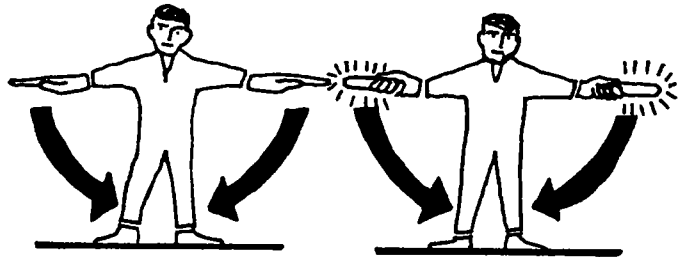

Conforms to ICAO signal

2. HORIZONTAL MOVEMENT

a. MOVE TO PORT (LEFT)

Right arm extended horizontally sideways in direction of movement and other arm swung in front of body in same direction, in a repeating movement.

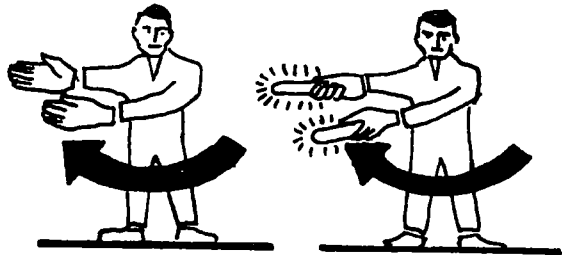

Conforms to ICAO signal

b. MOVE TO STARBOARD
(RIGHT)

Left arm extended horizontally sideways in direction of movement and other arm swung in front of body in same direction, in a repeating movement.

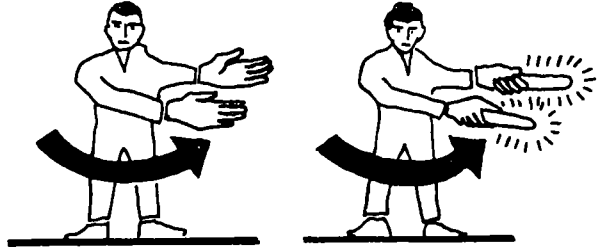

Conforms to ICAO signal

3. RELEASE LOAD

Left arm extended forward horizontally, fist clenched, right hand making horizontal slicing movement below the left fist, palm downward.

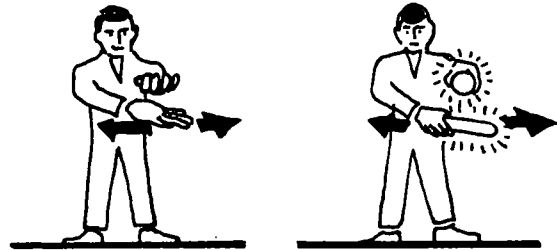

No equivalent ICAO signal

4. HOVER

Arms extended horizontally sideways, palms downward.

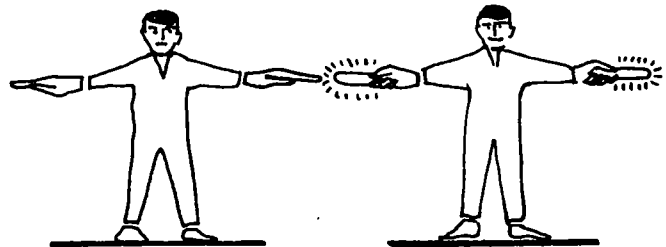

Conforms to ICAO signal

5. SPOT TURN

Left or right hand moving upward and backward, from a horizontal position, to indicate direction of tail movement. Other hand pointing to centre of spot turn. Marshaller must remain in full eye-view with pilot.

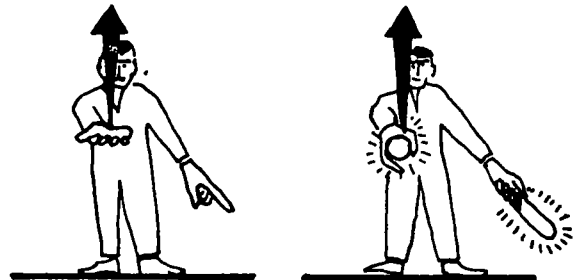

No equivalent ICAO signal

6. LAND

Arms crossed and extended downwards in front of the body.

Conforms to ICAO signal

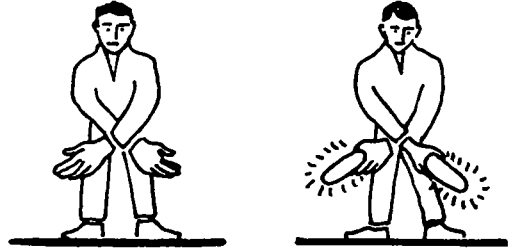

7. WINCH

a. WINCH UP

Left arm horizontal in front of body, fist clenched, right hand with palm turned upwards making upward motion.

No equivalent ICAO signal

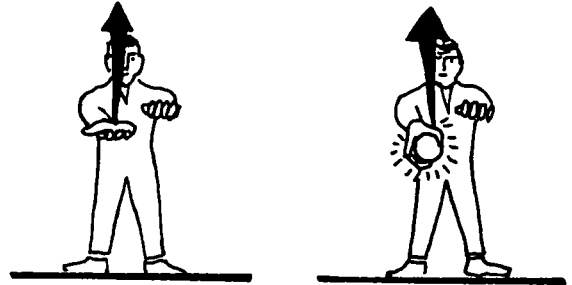

b. WINCH DOWN

Left arm horizontal in front of body, fist clenched, right hand with palm turned downwards making downward motion.

No equivalent ICAO signal

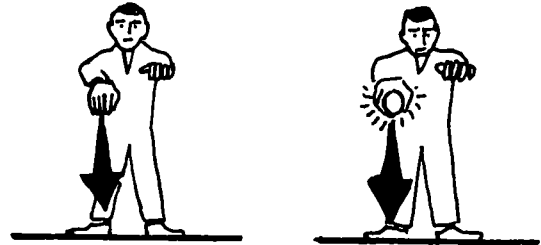

8. CUT CABLE

A signal the same as "RELEASE LOAD" to be used only when winching.

No equivalent ICAO signal

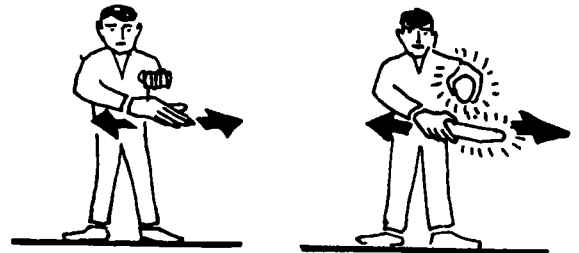

PART III

ADDITIONAL MARSHALLING SIGNALS
FOR NAVAL AIRCRAFT

1. WINGS

a. FOLD WINGS

Arms straight out at sides, then swept forward and hugged around shoulders.

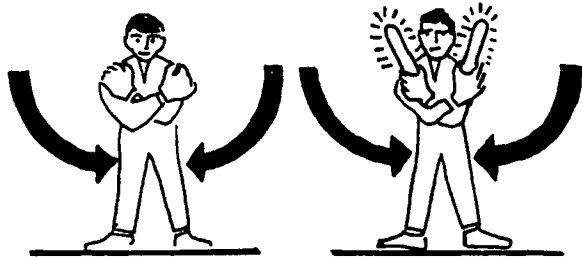

No equivalent ICAO signal

b. SPREAD WINGS

Arms hugged around shoulders, then swept straight out to the sides.

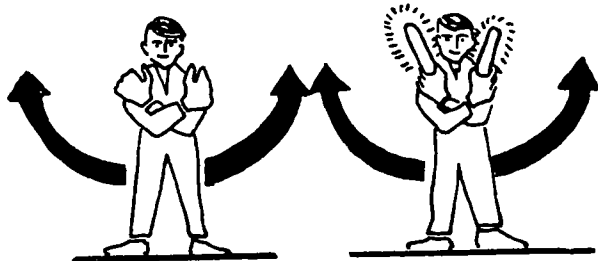

No equivalent ICAO signal

2. UP HOOK

Right fist, thumb extended upward, raised suddenly to meet horizontal palm of left hand.

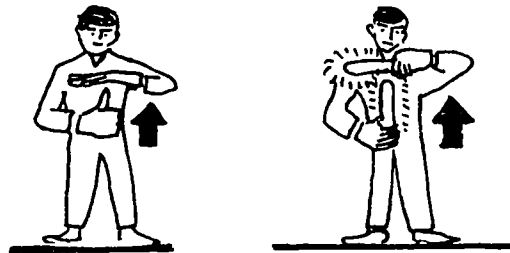

No equivalent ICAO signal

PART IV

DISTINCTIVE GARMENT TO BE WORN BY AIRCRAFT
MARSHALLERS

1. The distinctive garment described below will be worn by aircraft marshallers to enable flying personnel of one NATO Nation to identify as such the aircraft marshallers of another, and so to promote the safety and efficiency of NATO Forces.

2. The garment will be of fluorescent international orange colour and consist of a sleeveless garment, reaching to the waist both at the front and back, covering the shoulders and tied by ribbons at the waist. In order to facilitate operations the garment may be marked with individual numbers on the front and back at the discretion of participating nations.

APPENDIX VIII
STANAG NO. 3465
SAFETY, EMERGENCY AND SIGNALLING PROCEDURES
FOR AIR TRANSPORT AND AIRBORNE OPERATIONS

NATO—UNCLASSIFIED

Original French/English Translation

STANAG NO. 3465

DETAILS OF AGREEMENT

SAFETY, EMERGENCY AND SIGNALLING PROCEDURES FOR
AIR TRANSPORT AND AIRBORNE OPERATIONS

Enclosure: I. Annex "A"—Safety Perimeter and Vehicle Access Routes to
Transport Aircraft.

1. Safety on the Ground

For each type of aircraft, a safety perimeter must be defined and forbidden to all personnel not taking part in the maintenance, supplying and loading operations. Annex 'A' shows a typical safety perimeter.

a. Safety Perimeter

b. Vehicle Traffic

- (i) All traffic on the airfield will be regulated according to a traffic plan.
The speed of vehicles must be specified by panels on congested or dangerous routes.
- (ii) The movement of vehicles is forbidden within the safety perimeter except for supply, loading or unloading operations. A diagram for approach and clearing by vehicles is shown in Annex 'A'—Safety Perimeters.

c. Loading, Unloading and Supplying of Aircraft

- (i) In order to avoid any damage to the aircraft, the loading and unloading operations must be carried out under the control of a competent representative of the Air Transport Unit with experienced personnel and appropriate equipment.
- (ii) Special attention must be given to the movement of vehicles within the safety perimeter. In all cases chocks will be placed at such a distance that the vehicle cannot damage the aircraft.

NATO—UNCLASSIFIED

NATO—UNCLASSIFIED

- (iii) The loading and unloading of heavy or bulky loads must be carried out with special precautions.

d. Fire Risks

- (i) It is essential that all fire risks be eliminated on the hard standings. Any flame must be prohibited within 30 metres of the safety perimeter. Smoking will be prohibited within the same area.
- (ii) Fire extinguishing equipment (extinguishers, sand) must be placed in conspicuous positions near the hard standings.

e. Explosives, Ammunition, Dangerous Cargoes

- (i) Those must be stocked at the prescribed safety distance (where applicable) from the hard standings.
- (ii) The handling of this type of cargo must be carried out with the prescribed precautions. See STANAG 3327 as attached in Annex 'B'.

2. Safety Precautions Related to Air Transport

- a. Before each flight, the Captain of the aircraft or his designated representative must explain the emergency procedures to all transported personnel i.e. emergency, abandon aircraft, forced landing, and ditching signals. The dropping and emergency hang up signals will be tested before taxiing.
- b. Smoking will be prohibited inside the aircraft on the ground. In flight, permission to smoke will be granted at the discretion of the Captain of the aircraft or his designated representative. Under no circumstances will smoking be allowed:—
 - (i) during refuelling,
 - (ii) when fuel vapours are detected in the aircraft,
 - (iii) in aircraft with fuselage supplementary fuel tanks.
- c. All equipment (e.g. wheel chocks, tool boxes, luggage, cargo or safety equipment) must be lashed in the aircraft before taxiing. The lashing must be checked by the aircraft Captain or his designated representative during pre-flight inspection and periodically during flight.
- d. Before the taxiing, crew and passengers must remain strapped in. They must remain attached until the Captain of the aircraft or his designated representative authorises the unfastening of safety belts.

During flight, on the order of the Captain of the aircraft, the safety belts will be fixed. The same will apply before landing. In the latter case, the belts will only be unhooked after the aircraft has come to rest on the hard standing, all engines stopped. This procedure may be changed in the case of assault landings.
- e. During airborne and air transport operations, the wearing of parachutes by the crew and airborne personnel will be as prescribed by the national authority operating the aircraft.
- f. In flight, over water, life jackets will be worn at the discretion of the Captain or his designated representative.

NATO—UNCLASSIFIED

- g. In flight, movements by passengers in the aircraft will be kept to a minimum. Only personnel authorized by the Captain of the aircraft or his designated representative may enter the crew compartment.
- h. The Captain of the aircraft is responsible for ensuring that passengers obey the safety and emergency rules.
- j. All dangerous material will be stowed in such a manner that it will be easily accessible in flight without moving other cargo.
- k. All dangerous material will be loaded and stored away from oxygen and heating outlets sources of heat and away from sources of sparks, such as auxiliary power generators and invertors.

3. Safety on the Dropping/Landing Zones

a. Safety on the Dropping Zones

The designated Commander of the operation will allocate responsibility for safety on the dropping zones. This may include:

- (i) marking of the dropping zone,
- (ii) operating radio-communication facilities with aircraft in flight, and radio-electric or electronic aids,
- (iii) freeing of the dropping zone of all non-essential personnel and equipment,
- (iv) ensuring the presence of medical personnel and means for medical evacuation (by land or by air),
- (v) re-forwarding meteorological data, results of parachuting and any other information which may have an influence on the safety of the dropping or the flights,
- (vi) Cancellation, postponement or renewal of the operation.

b. Safety on the Landing Zones

The Commander of the detachment in local control of the landing zone will be responsible for :

- (i) inspecting runways, taxiways and hard standings before the beginning of operations and at regular intervals during the maneuver,
- (ii) marking the landing zone,
- (iii) noting and marking obstacles on the landing and take-off axis,
- (iv) operating radio-electric and electronic facilities,
- (v) observing and coordinating aircraft traffic,
- (vi) evaluating and transmitting to aircraft, data which might affect the safety of landings and take off:
 - wind (force and direction)
 - presence of vehicles, aircraft and personnel on or near the landing zone
 - presence of aircraft operating within the circuit
 - presence of obstacles to approach or take off
 - enemy action.

- (vii) should conditions become such that take-off and landing will no longer be safe, informing the Commander on the ground; the latter will decide whether to cancel, or continue the operation and will inform the Commander of the operation,
- (viii) retransmitting the orders of the Ground Commander.

4. Emergency Signals and Procedures

It is the responsibility of the Captain of the Aircraft to ensure that all his passengers are briefed, before the engines are started, on the emergency signals and procedures. These signals are to be tested before taxiing and are then not to be used again except in emergency.

In flight, as soon as the emergency signal is given, the proper instructions must be brought to the notice of passengers by a member of the crew. Should it be necessary to lighten the aircraft in flight, the passengers may be called upon to help the crew to jettison the cargo. Passengers provided with parachutes and helmets will adjust them with the help of a member of the crew. These signals and procedures are:

a. Abandon Aircraft

On the signal "abandon aircraft", passengers will give a last check to the adjustment of their parachutes and jump. They will leave the aircraft in order and as quickly as possible under the direction of the Chief of transport (or dispatcher).

b. Ditching

- (i) On the emergency signal, after hearing the instructions on imminent ditching, given by a member of the crew, the passengers:
 - will, if required, assist in lightening the aircraft or lashing unlash cargo,
 - take off their parachute,
 - adjust their safety jacket and helmet,
 - fasten their safety belt.
- (ii) Whilst awaiting ditching, passengers will prop themselves up, using all possible means of padding, e.g. parachutes etc.
- (iii) When the aircraft has stopped, passenger and crews
 - will carry away all safety equipment (dinghies, emergency kits) as planned,
 - will leave the aircraft in order by the prescribed exits.

c. Forced Landing

- (i) On the emergency signal, after hearing the instructions given by a member of the crew, passenger will
 - if necessary, help in lightening the aircraft or lashing unlash cargo,
 - adjust their helmets,
 - attach their safety belts.
- (ii) Whilst awaiting landing, passengers will prop themselves up using all available means as padding.

NATO—UNCLASSIFIED

- (iii) When the aircraft has stopped, they will leave the aircraft in order as quickly as possible by the prescribed exits.

d. Fire in Flight

In the case of fire in the cargo compartment, passengers will:

- (i) inform the crew immediately,
- (ii) assist them in extinguishing the fire.

5. In Flight Dropping Procedures

a. Dropping Signals

- (i) At a specified time before "p" hour, the dispatcher (s) (or stower-dispatcher (s)) will take up his appointed place, intercom switched on, to receive the orders of the Captain of the aircraft or his designated representative.
- (ii) The jumping and dropping signals will be as follows:

| COMMAND | Method and Means of Signal | Time of Signal | Remarks |
|--------------------------------|--|---------------------|------------------|
| (A) Prepare for action | Visual/Verbal | As briefed | |
| (B) Action Stations | Verbal followed by Continuous Red Light | As briefed | |
| (C) Go | Red Light goes out Continuous Green Light Verbal Warning (if applicable) Sound Warning (if applicable) | P | P = Jumping Hour |
| (D) End of Jump or End of Drop | Sound Signal for "Stop" (if applicable) Green Light goes out Continuous Red Light | End of Jump or Drop | |

b. Emergency Signalling Procedure

| COMMAND | Method and Means of Signal | Remarks |
|--|------------------------------------|---|
| Emergency Signal | 3 Red Flashes | |
| Prepare (to abandon aircraft (for forced landing (ditching | Red Light | Verbal instructions are given to passengers regarding further action. |
| Abandon aircraft | Possibly "hooter" and Green Light) | |

SAFETY PERIMETER AND VEHICLE ACCESS ROUTES TO TRANSPORT AIRCRAFT
PERIMETRE DE SECURITE ET SCHEMA D'APPROCHE ET DE DEGAGEMENT DES VEHICLES

Annex "A" to
STANAG 3465

Annexe "A" au
STANAG 3465

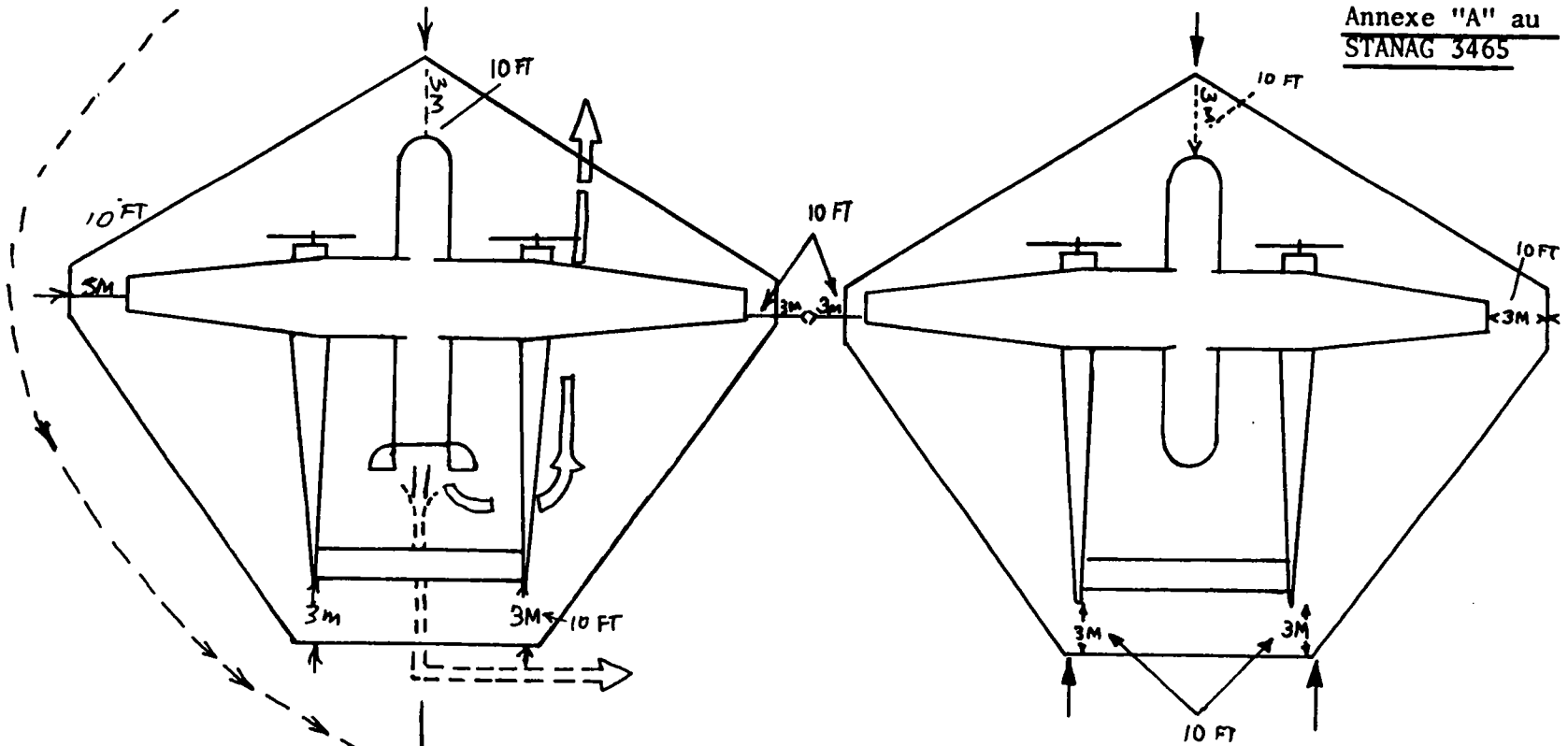

- > Approche autorisee - Authorized Approach to the Aircraft
- > Degagement autorisee - Authorized Exit Path from the Aircraft
- ====> Approche interdite - Forbidden Approach Path to the Aircraft
- ====> Degagement interdit - Forbidden Exit Path From the Aircraft

OTAN - NON CLASSIFIE

By Order of the Secretary of the Army:

HAROLD K. JOHNSON,
General, United States Army,
Chief of Staff.

Official:

J. C. LAMBERT,
Major General, United States Army,
The Adjutant General.

Distribution:

Active Army:

| | |
|------------------|--------------------------|
| DCSPER (2) | USACDCCCISG (6) |
| ACSI (2) | Units org under fol TOE: |
| DCSLOG (2) | 1-47 (2) |
| DCSOPS (2) | 1-55 (5) |
| ACSFOR (2) | 1-57 (2) |
| CORC (2) | 1-58 (2) |
| CRD (1) | 1-59 (2) |
| COA (1) | 1-67 (2) |
| CINFO (1) | 1-75 (5) |
| TIG (1) | 1-77 (2) |
| TJAG (1) | 1-78 (2) |
| TPMG (1) | 1-127 (2) |
| TSG (1) | 1-137 (2) |
| OPO (1) | 1-252 (2) |
| CofEngrs (3) | 1-256 (2) |
| CofCh (1) | 1-257 (2) |
| USAMB (2) | 1-258 (2) |
| USACDC Agcy (5) | 1-259 (2) |
| USCONARC (10) | 1-307 (2) |
| USACDC (10) | 5-36 (1) |
| USAMC (15) | 6-517 (2) |
| ARADCOM (10) | 8-137 (2) |
| ARADCOM Rgn (10) | 11-15 (2) |
| OS Maj Comd (5) | 11-95 (2) |
| LOGCOMD (5) | 17-408 (2) |
| Armies (25) | 30-5 (2) |
| Corps (15) | 55-51 (2) |
| Div (10) | 55-54 (2) |
| Div Arty (5) | 55-56 (5) |
| Bde (5) | 55-57 (2) |
| Regt/Gp (5) | 55-58 (2) |
| CC (5) | 55-59 (2) |
| USMA (10) | 55-66 (5) |
| MFSS (2) | 55-89 (2) |
| USASCS (10) | 55-99 (2) |
| USALMC (3) | 55-457 (2) |
| USACDCIAS (1) | 55-458 (2) |
| USACDCEC (5) | 55-459 (2) |
| USACDCNG (1) | |

NG: State AG (3); units—same as active Army except allowance is one copy to each unit.

USAR: Units—same as active Army except allowance is one copy to each unit.

For explanation of abbreviations used, see AR 320-50.

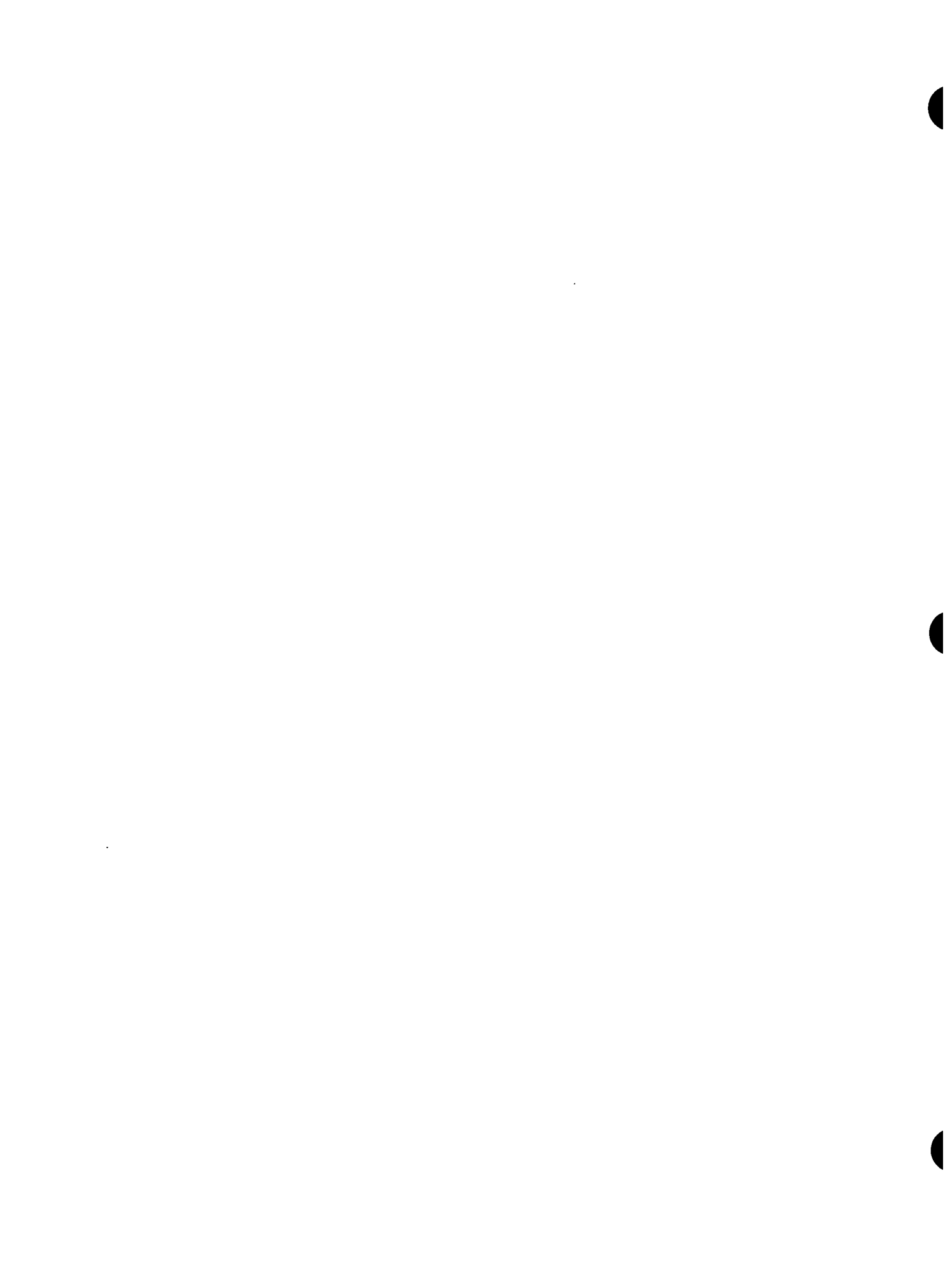



3000021284



