

FM 5-30

DEPARTMENT OF THE ARMY FIELD MANUAL

**ENGINEER
INTELLIGENCE**



**HEADQUARTERS, DEPARTMENT OF THE ARMY
SEPTEMBER 1967**

FIELD MANUAL }
 No. 5-30 }

HEADQUARTERS
 DEPARTMENT OF THE ARMY
 WASHINGTON, D.C., 22 September 1967

ENGINEER INTELLIGENCE

	Paragraph	Page
CHAPTER 1. INTRODUCTION -----	1-3	3
2. SUBJECT FIELDS OF ENGINEER INTELLIGENCE -----	4-7	4
3. ENGINEER INTELLIGENCE AT THE NATIONAL LEVEL -----	8-11	7
4. ENGINEER INTELLIGENCE IN THE THEATER OF OPERATIONS -----	12-18	9
5. THE COLLECTION PHASE -----	19-34	13
6. THE PRODUCTION PHASE -----	35-44	31
7. THE DISSEMINATION PHASE -----	45-48	35
8. STRATEGIC AND TACTICAL PLANNING AND OPERATIONS -----	49-53	39
9. ENGINEER TOPOGRAPHIC AND INTELLIGENCE UNITS AND CIVIL AFFAIRS -----	54-60	41
10. ENGINEER INTELLIGENCE TRAINING -----	61-64	44
APPENDIX A. REFERENCES -----		45
B. SAMPLE ENGINEER INTELLIGENCE PERIODIC REPORT -----		47
C. SAMPLE ENGINEER INTELLIGENCE ANNEX -----		48
D. SAMPLE INTELLIGENCE REPORT ON ENEMY MATERIEL -----		51
INDEX -----		55

*This manual supersedes FM 5-30, 12 May 1959.

CHAPTER 1

INTRODUCTION

1. Purpose and Scope

a. This manual is a training text and general reference for all personnel concerned with engineer intelligence. It serves as a guide for commanders and their staffs in understanding the purpose and scope of engineer intelligence and how the engineers may be utilized to meet their intelligence requirements.

b. The information in this manual deals with the concept and role of engineer intelligence both in the zone of the interior and in the theater of operations. The material presented is applicable without modification to all forms of warfare, both nuclear and nonnuclear.

2. Changes and Comments

Users of this manual are encouraged to submit recommended changes or comments to improve it. Comments should be keyed to the

specific page, paragraph, and line of the text in which the change is recommended. Reasons should be provided for each comment to assure understanding and complete evaluation. Comments should be forwarded to the Commandant, U. S. Army Engineer School, Fort Belvoir, Virginia 22060.

3. Relation to Other Manuals

The material presented in this manual is related to the field manuals of the 30-series. They deal with intelligence techniques of the Army and also with those applicable to other arms and services and to special situations. FM 100-5, FM 100-15, and FM 101-5 cover intelligence in general staff activities and in the plans and operations of large units. Field manuals of the 5-series contain information on the intelligence responsibilities of engineer troop units.

CHAPTER 2

SUBJECT FIELDS OF ENGINEER INTELLIGENCE

4. Scope of Engineer Information

Engineer information is data in any form (oral, written, or graphic) on—

a. The terrain, including the location, identity, and physical description of natural and manmade features.

b. Research and development of materiel and techniques corresponding to that materiel and those techniques which are of interest and use to the Corps of Engineers.

c. Design, manufacture (including the capabilities of agencies engaged in manufacture), mechanical functioning, military and civilian inventories, supply (including procurement, storage, and issue), and maintenance of materiel corresponding to the materiel of interest and use to the Corps of Engineers.

d. Employment of materiel, techniques, and organizations corresponding to that materiel and those techniques and organizations for which the Corps of Engineers is responsible.

e. The order of battle of engineer units and similar information on civilian organizations capable of performing engineer missions.

f. The identity and accomplishments of outstanding civilians in the fields of technology corresponding to those fields for which the Corps of Engineers is responsible.

5. Engineer Intelligence

a. Description. Engineer intelligence is engineer information which has been evaluated as to its accuracy and reliability and accepted as fact. It is then related to specific military activities and used by commanders at all echelons in planning military operations or construction.

b. Scope. Engineer intelligence is very comprehensive. In its broadest sense, it covers all fields of activity of the Corps of Engineers at

all levels, and is also a part of area and geographic intelligence.

c. Categories. The following is a list of captions under which engineer intelligence is normally categorized.

- (1) Airfields, including air landing zones and heliports.
- (2) Coasts and landing beaches.
- (3) Construction resources.
- (4) Defenses.
- (5) Electric power.
- (6) Engineer logistics.
- (7) Engineer materiel and resources.
- (8) Engineer operations.
- (9) Engineer organization.
- (10) Engineer training.
- (11) Engineer Who's Who (Specialists).
- (12) Geographic intelligence.
- (13) Geology.
- (14) Hydrology and ground water.
- (15) Highways.
- (16) Inland waterways.
- (17) Lines of communication.
- (18) Military and civilian construction.
- (19) Petroleum and gas.
- (20) Ports and harbors.
- (21) Railways.
- (22) Soils.
- (23) Solid fuels.
- (24) State of ground and trafficability.
- (25) Surface configuration, maps, and charts.
- (26) Terrain studies and analysis.
- (27) Urban areas.
- (28) Vegetation.

d. Application. Although some of the engineer subjects listed above are no longer handled entirely by Corps of Engineers units, the information is still of vital concern to organizational elements engaged in military engineering activities and to combat commanders. The lat-

ter normally rely on their staff engineer for data pertaining to engineer intelligence.

e. References. AR 117-5, SR 115-15-5, FM 30-10 series, FM 5-1, TM 5-231, and TOE 5-540 discuss engineer topographic intelligence and intelligence teams in more detail.

f. Need for Engineer Intelligence. Engineer intelligence has always been an important factor in military operations, but under present conditions of warfare the need for engineer intelligence has increased tremendously. Areas of operations have expanded, mobility has increased, and rapid changes have occurred in technology and in the facilities necessary to support modern warfare. Along with these increases, the time available to respond to problems has decreased. Airfield and landing zone construction to support greater mobility, the nuclear weapons, and guerrilla warfare are only a few factors that have increased the need of engineer intelligence.

g. Individual Responsibility for Supplying Engineer Intelligence. Engineer intelligence is needed by everyone; and it is every engineer's responsibility to supply information to be developed into engineer intelligence. Though there are established courses and schools to train intelligence specialists and to teach technical methods of collecting information and producing engineer intelligence, every engineer soldier must know the importance of intelligence and be trained in collecting whatever information he can and placing it into the appropriate intelligence channels. The importance of the individual's role should be stressed by all commanders.

h. Nature of Intelligence Data. The nature of intelligence data required varies at different levels. Strategic intelligence normally pertains to theater army, theater, Department of the Army, and higher levels, and combat intelligence to army group and lower levels. However, no hard and fast line can be drawn, since the same item of engineer intelligence may be needed by engineers and others at all levels within a theater. For example, the existence, condition, capacity, rolling stock, and facilities of an axial railroad in a certain theater may affect a decision at Department of Defense level. It may also be an important element in the strategic and logistical planning at theater and theater army level. Data on its structural

features will be needed by engineers if extension, reconstruction, or large-scale demolition is required. This information will also be needed by the commanders and staffs of any engineer brigades, groups, battalions, or other commands charged with such work, as well as by the units which operate the railroad.

i. Nuclear, Biological, and Chemical Warfare. An important area of intelligence effort which will increasingly concern the Corps of Engineers is nuclear, biological, and chemical warfare. Engineers are interested in studies to evaluate the destructive effects of nuclear weapons on the natural terrain, aboveground and underground structures and installations, equipment, stored supplies, and personnel; and in the influence of terrain and weather on these effects. Of particular interest will be the ability to improvise or deliberately design protective structures to withstand a nuclear explosion, to protect personnel from radiation, and to aid in recovery from the effects of a nuclear explosion. Intelligence reports on such items as soils, atmospheric conditions, and various works of man, including roads, railroads, bridges, airfields, ports, utilities, urban areas, and military installations, should always consider the nuclear aspects of the subject under study.

6. Relation of Engineer Intelligence to Other Intelligence

a. Engineer intelligence involves all the activities of the Corps of Engineers and all engineer units. Engineer intelligence is of vital interest and use to other arms, services, agencies, civil affairs units, special forces, and Military Assistance Advisory Groups (MAAG). Similarly, many items of general combat intelligence are of interest to engineers. In addition there is direct exchange of information between engineer intelligence and other intelligence agencies, to include the technical and administrative services and combat arms. For example, civil affairs units and agencies and advisory personnel are very much concerned with engineer intelligence. They need to know the aspects of the terrain, natural resources that can be developed and used, sources of construction materials, water supply, lines of communication, urban and rural area development, what can be done and what should not be done from an engineer standpoint, and much other engi-

neer intelligence to assist them in their operations.

b. Proper coordination and control are necessary to prevent duplication, confusion, incomplete intelligence data, and possible failure of the intelligence mission. This is necessary especially in cases where intelligence information is of vital interest to more than one agency. Continuing the earlier example of intelligence on a railroad, such intelligence may be of overlapping interest to engineers, transportation personnel, and other agencies. The engineer is interested in new construction and rehabilitation; transportation units, in technical supervision and operation; and other agencies and commands, in data for planning and logistical support. On the other hand, data collected by one agency may be incomplete from the standpoint of other agencies. Transportation units might be more concerned with information on rolling stock and the general condition of the railroad. The engineers may need more specific information in order to estimate the time needed to repair or rehabilitate the line, and they must know the sources of materials, special loads, volume of traffic, soils, drainage, and planned expansion. Still other agencies might be concerned only about interdiction of the local population. Frequently, commanders must defer decision until data gathered by various sources is assembled and evaluated.

7. Relation of the Engineer to the Intelligence Officer

a. The commander is responsible for all intelligence activities of his command. The intelligence officer is responsible for the overall direction and coordination of intelligence activities according to the operation plan and the commander's policies, thus exercising staff responsibility.

b. The intelligence officer informs the staff engineer of the commander's needs for engineer information. The engineer, through various intelligence agencies and engineer units, collects the information required by the commander and prepares appropriate reports and studies. Often he sends requirements to other appropriate intelligence units through intelligence officers or channels to obtain specific answers or special information. The engineer intelligence is then given to the intelligence officer who informs the commander and also disseminates it to subordinate, adjacent, and higher headquarters and to technical units whenever required. Though there may be special or one-time intelligence requests, the intelligence process is in action constantly.

c. The intelligence officer gives the engineer any engineer information and intelligence which he may have obtained from other branches, services, and technical units for the engineer to process, or to use and disseminate through technical channels.

CHAPTER 3

ENGINEER INTELLIGENCE AT THE NATIONAL LEVEL

8. Engineer Intelligence Responsibility in the Zone of Interior

The Defense Intelligence Agency (DIA) is responsible for the collection, production, and dissemination of intelligence within the Department of Defense. The U. S. Army Foreign Science and Technology Center (FSTC), which is part of the Army Materiel Command, produces engineer technical intelligence, the Chief of Engineers has Department of the Army staff responsibility to provide program guidance to Army component commands on their requirements for military geographic intelligence. Within the Corps of Engineers, the Army Map Service (AMS) and the U. S. Army Geodesy, Intelligence, and Mapping Research and Development Agency (GIMRADA) are the primary elements that deal with national level intelligence.

9. Engineer Intelligence Support for CONUS-Based Commands

Subordinate units within each CONUS-based command provide the required engineer intelligence support. For those commands in which a single service predominates, engineer intelligence support is provided by a command intelligence center. In a unified command, the Army component provides the support. Although there are a variety of ways in which the Army provides support, both to itself and to other services, the best support is provided to those units to which an engineer terrain detachment is assigned.

10. Army Map Service

The Army Map Service is a Class II installation under the command of the Chief of Engineers. It produces, stores, and distributes maps, geodetic data, and related materials and operates a central library of maps, geodetic and astronomic data, and related publications

for the common use of the Department of Defense.

a. As custodian, the Army Map Service will—

- (1) Recognize any previous agreements which may affect the ownership or dissemination of any items received.
- (2) Furnish automatically to authorized agencies current accession lists of items received and catalogs of items available.
- (3) Make mutually satisfactory arrangements with the other agencies for simultaneous exploitation by any two or more agencies of maps and map information.
- (4) Maintain a suitable recording and distribution system supplemented by reproduction facilities to the end that authorized agencies may secure promptly the information required to carry out their respective responsibilities.

b. Army Map Service custodial responsibility applies to—

- (1) Standard topographic maps of any scale.
- (2) Road, railroad, and inland water transportation maps.
- (3) Military city maps and town plans.
- (4) Other maps which can be used in compiling standard military maps and charts.
- (5) Map catalogs and lists.
- (6) Books, documents, and manuscripts containing information on cartography, photogrammetry, lithographic reproduction, and relief mapping; general geographies; glossaries; gazetteers; linguistic items; survey

records; geodetic control data; high precision short range navigation (HIRAN) records; computation data for map projections and grids; and data on magnetic declination, the variation of terrestrial gravity, and related matters.

- (7) Unique topographic base maps containing overprints illustrating reports, order of battle information, or other such information.

c. Three copies of each item detailed in *b* above produced for military purposes will be furnished promptly by the originator to the Army Map Service.

d. Army Map Service custodial responsibility does not apply to—

- (1) Hydrographic items of primary interest to the Naval Oceanographic Office.
- (2) Aeronautical charts of primary interest to the Aeronautical Chart and Information Center.
- (3) Weather maps.
- (4) Maps and map intelligence material that are primarily intelligence documents such as industrial, economic, political, population, ethnographic. This includes maps on which intelligence information has been placed, such as order-of-battle data or information illustrating a report when the map itself has no special value as a

unique source of topographic information.

- (5) Airfield data when such do not contain information of topographic value.

e. Direct contact is authorized between the Army Map Service and all agencies, military and civilian, needing or able to supply topographical information and source materials, except as otherwise indicated by current regulations or directives. Direct contact for translation services required on topographic items is authorized between the Army Map Service and the agencies performing translation functions.

f. The Department of Defense topographic map and geodetic libraries are operated by the Army Map Service under the command of the Chief of Engineers. AMS maintains a central catalog and file of maps, ground control (including geodetic and astronomical position data) and related publications for DOD.

11. The U. S. Army Engineer Geodesy, Intelligence, and Mapping Research and Development Agency (GIMRADA)

The U. S. Army Engineer Geodesy, Intelligence and Mapping Research and Development Agency is a Corps of Engineers activity operating under the command of the Chief of Engineers for the accomplishment of all research and development, test and evaluation of equipment, systems and techniques in the specific field of geodesy, mapping, and military geographic intelligence.

CHAPTER 4

ENGINEER INTELLIGENCE IN THE THEATER OF OPERATIONS

12. Staff Organization

The fundamental considerations in the organization of a staff depends on the mission to be accomplished. There are now two basic types of U. S. Army staffs, the general staff and the directorate staff. Although differences exist in the application of the staff organization (FM 101-5), each staff includes coordinating and special staff officers.

13. Theater Army Engineer

In the theater army headquarters, the engineer is a member of the special staff if the headquarters is organized under the general staff structure. If the headquarters is organized under the directorate structure of the "J" staff structure, the engineer is integrated into the coordinating staff group. In either case, the responsibilities of the engineer remain the same as given in FM 101-5. The theater army engineer is the planner, supervisor, and coordinator of all army engineer activities within the theater. He is responsible for producing engineer intelligence and provides information and technical advice for the theater commander and for the theater's general and special staffs. He keeps them current on the condition, capabilities, and requirements of the engineer elements assigned to the command and converts the commander's decisions into operational plans for the engineers.

a. Coordination With Other Units. The theater army engineer deals with various agencies in obtaining or exchanging engineer intelligence data. In addition to the coordination with J2 or Army G2 and other staff officers at theater headquarters, he deals with—

- (1) Engineers of subordinate headquarters, especially with field armies, communications zone (COMMZ), and

special task forces, through engineer technical channels.

- (2) Navy and Air Force agencies under the theater Navy and theater Air Force commanders, by direct contact, through liaison officers, or through formal channels as may be prescribed by theater J2 or theater army G2.
- (3) Allies with whom there is contact at theater or theater army level, by direct contact with a coordinating headquarters of the allied armed forces or with the war office or equivalent. The channels for such contacts are prescribed by the theater commander or higher authority.

b. Organization of an Engineer Command. The commander may strengthen his engineer support by organizing an engineer command (TOE 5-201) to perform operational planning and supervision and the coordination of activities of assigned or attached engineer construction brigades, groups and other units engaged in construction, mapping, and related activities.

c. Organization of an Engineer Intelligence Division. There is no prescribed organization for the engineer intelligence division. It varies with the nature, size, and characteristics of the theater and the forces engaged.

14. Field Army

Each field army is authorized an engineer brigade to command, control, and coordinate the activities of the nondivisional engineer units assigned to it. The commander of this brigade serves on the staff of the field army commander in a dual capacity as the brigade commander and the field army engineer.

a. Army Engineer Section. This section is located at field army headquarters and assists

the army engineer brigade commander in executing his responsibilities in his capacity as field army engineer. One of the responsibilities of this section is the supplying of engineer intelligence by its intelligence and mapping branch.

b. Intelligence and Mapping Branch. The intelligence and mapping branch collects and evaluates information and disseminates engineer intelligence. It exercises technical supervision and, at times, operational direction over engineer intelligence teams assigned to the field army. It handles all matters pertaining to the preparation, revision, reproduction, and distribution of maps and map substitutes and engineer intelligence as far as they pertain to the army engineer's sphere of responsibility and within the frame work of field army policy as prescribed by G2. This branch works closely with G2.

15. Corps

Each corps of a field army is authorized an engineer brigade (TOE 5-101). The brigade may have two to four engineer groups, depending upon engineer requirements. The commander of the engineer brigade, corps, serves as the corps engineer. The operation of the corps engineer section is similar to the army engineer section, but at a smaller scale. Normally an engineer topographic company, corps is assigned to each corps in the field. This unit is needed for normal mapping support and for cartographic and reproduction support for most terrain analysis studies and reports.

16. Division

Each division has an engineer combat battalion. Each combat battalion is authorized a division engineer section. The commander of these battalions serves in dual capacity, as battalion commander and the division engineer (FM 101-5). The assistant division engineer (ADE) supervises the engineer section which is normally located at division headquarters.

a. Intelligence. The division engineer obtains intelligence from higher headquarters through channels. He, however, has the definite responsibility for the collection and some of the processing of engineer information within the divisional zone or sector.

b. Division Engineer's Intelligence Activities. The division engineer furnishes timely information to the division commander and his staff on the following: terrain, minefields and obstacles, effects of weather, effects of nuclear detonation on the terrain, enemy fortifications, enemy engineer troops and their capabilities, enemy equipment and materiel, enemy techniques, lines of communication, and sources of usable engineer supplies and equipment. The division engineer works closely with the G2 in the preparation of the intelligence estimates and the intelligence annexes (FM 30-5). Spot reports on enemy engineer materiel should be disseminated through the G2 to the units of the division and technical intelligence units as quickly as possible.

c. Division Engineer's Responsibility to the Battalion. As the battalion commander, he directs its intelligence activities, assisted by the battalion S2. His principal intelligence activities are—

- (1) Receiving, evaluating, analyzing, and interpreting reconnaissance data into engineer intelligence.
- (2) Disseminating intelligence information to subordinate and supporting units.
- (3) Preparing terrain analyses and studies for battalion use when required.
- (4) Supervising intelligence training of divisional engineer battalion.

d. Sources of Engineer Information. The division engineer obtains engineer information from the units of his battalion, from adjacent and higher headquarters, and from engineer and other intelligence units. One of the best sources of engineer intelligence is the engineers and other members of the division. At the division level, ground and short-range aerial reconnaissance and reports from other frontline troops are vital. Much of the engineer intelligence developed at division level is needed by other agencies. This need is met by dissemination to all who require it.

17. Topographic and Intelligence Units

a. Topographic Troop Units.

- (1) Topographic units include the corps topographic company, the army topo-

graphic battalion, the base topographic battalion, and certain teams of the engineer service organization. Among them they perform the various engineer mapping functions required for a theater of operations. These units—

- (a) Provide direct mapping support to the appropriate commands to which assigned.
 - (b) Furnish ground control for artillery and missile fire.
 - (c) Perform evaluation of aerial photography as required.
 - (d) Assist in the accomplishment of the Department of the Army and theater mapping program in coordination with the Chief of Engineers.
- (2) The normal assignment of a topographic unit is to theater, field army, or corps. As the mapping situation changes, a unit may be shifted from its normal assignment to answer particular mapping requirements, but must usually be augmented. The topographic company, corps, for example, is neither organized nor equipped to perform extensive original map compilations and can therefore be employed in such a capacity only if augmented.
- (3) The engineer topographic support available for a typical theater of operations is normally adequate for supplying the theater with its topographic needs. Small TOE 5-540 topographic units with personnel and equipment of platoon or team size are provided for special purpose mission and/or augmentation of regular units. Additional capabilities to accomplish a peacetime mapping program may also be obtained from Allied government agencies as the result of cooperative mapping agreements.

b. Base Topographic Battalion. The base topographic battalion has an elaborate and flexible organization reflecting its varied mis-

sions. It is composed of a headquarters and headquarters company and four other companies comprising a base survey company, a base reproduction company, a base photomapping company, and a base map depot company. The photomapping and reproduction elements require semipermanent or permanent air-conditioned facilities in a location undisturbed by airfield, railroad, streetcars, demolitions, and like vibratory disturbances and supported by reliable utilities. Teams are attached to the battalion or its components for special situations to increase their capabilities. The battalion operates in the communications zone (normal assignment is one per communications zone) and is under the operation control of the theater engineer. Normally, it is attached to an engineer construction command or an engineer construction brigade. The battalion provides basic materials, such as trigonometrics tables and map reproduces, to army and corps topographic units. It procures, compiles, reproduces, and distributes military maps, which, when combined with the efforts of all other topographic units, meet the requirements of a theater of operations. It conducts surveys of an accuracy suitable for ground mapping and artillery and missile fire; it assists the theater army G2 and the theater army engineer in the preparation of terrain studies and reports.

c. Topographic Battalion, Army. The engineer topographic battalion, army, operates within the field army area, on a basis of one per field army, and consists of a headquarters and headquarters company, a map reproduction and distribution company, and a photomapping company. The battalion commander coordinates the planning and execution of mapping activities with the army engineer and his staff. The battalion provides maps and engineer mapping and artillery and missile fire control information as required for a field army; reproduces new and existing maps and other intelligence materials; stores and distributes maps and similar materials; performs topographic surveys and provides survey information required by a field army; and when directed, prepares engineer intelligence reports. The base topographic battalion supports the army topographic battalion by supplying basic materials, such as trigonometric tables and map repro-

ducibles, and by carrying horizontal and vertical survey control forward. In turn, the army battalion supports the corps topographic company by furnishing basic mapping material and extending survey control forward for pick-up by the corps companies. When not fully employed on its normal function of producing maps for use by army, the battalion assists the base topographic battalion in the execution of the theater mapping program.

d. Topographic Company, Corps. Each corps is supported by one engineer topographic company which is designed and organized for the purpose of compiling, revising, reproducing, and distributing maps, and for extending and establishing ground control for mapping and artillery in support of corps operations. Map compilation is limited to provisional maps. The company commander advises the corps staff and assists the corps engineer in determining the mapping needs of corps units. He also coordinates with the corps artillery officer the requirements of the artillery in connection with fire control. The company is most effective when it operates close to corps headquarters. When not fully employed on its primary function of producing maps for use by the corps, the company assists base and army topographic units in the prosecution of the theater mapping program.

e. Teams. The engineer service organization has various types of teams for topographic work. Included in these are survey, photomapping, evaluation, geodetic survey, hydrologic and terrain teams. These teams are assigned, as required, to supplement the mapping,

geodetic, and intelligence capabilities of the topographic companies and battalions. A list of the teams and their missions, and basis of allocation and assignment are outlined in chapter 9.

18. Other Units

a. Engineer Combat Battalion, Army or Corps (TOE 5-35). The mission of this unit is to increase the combat effectiveness of corps and army by supplying engineer combat support and performing general engineer work. It produces engineer intelligence for its own use and as directed. It receives intelligence through technical and command channels.

b. Engineer Combat Group. This unit is normally assigned or attached to corps and army with normal attachment to an engineer brigade. In addition to its other activities, this unit provides engineer reconnaissance by air and ground means and supervises engineer intelligence collection activities. It also prepares terrain and other engineer intelligence reports when required or directed and evaluates and disseminates engineer intelligence.

c. Engineer Construction Groups and Battalions (TOE 5-112, TOE 5-114, TOE 5-115, TOE 5-116, TOE 5-119, and TOE 5-118). These units are construction units, and have a limited intelligence organization which can provide invaluable information and intelligence when required.

d. Additional Information. Additional and more detailed information on engineer intelligence units and their activities is given in FM 5-1, FM 30-5, FM 5-36, and other FM 5-series.

CHAPTER 5

THE COLLECTION PHASE

19. Collection of Information

Sources of engineer information are almost unlimited. These include maps of all kinds, photographs, technical journals, commercial publications, specifications of civil works, data on construction projects, civilian and military transportation organizations, intelligence personnel, prisoners of war, and defectors, to mention only a few. Both civilians and military personnel, many of which are not specialists in the field of intelligence, are potential sources of engineer information.

20. Engineer Intelligence Specialists

The mission of intelligence specialists is to obtain information. They know what information is required and how to obtain it. Personnel specifically trained for intelligence are found in S2, G2, J2 of engineer units and agencies, terrain teams, and topographic units. They are assisted by various technical specialists such as photographers, imagery interpreters, and other personnel not specifically trained in intelligence. The intelligence specialist finds and collects pertinent facts and disseminates and reports the engineer information in various ways, often on forms used throughout intelligence agencies, such as DD Form 1396 (Department of Defense Intelligence Information Report).

21. Observation by Other Engineer Personnel

Although much specific and precise information is obtained by trained observers and intelligence personnel, engineers not specifically trained or assigned to intelligence activities are a potential source of engineer intelligence. For example, troops on a combat mission can observe and report the distance between large trees in an area and how effective the vegeta-

tion is for concealment and cover. They can report the effect streams have on movement, the existence of tracks and trails that do not show on maps or are shown incorrectly, the presence of caves and tunnels, the existence of footbridges and fords, patches of cultivated ground in seemingly uninhabited areas, possible landing zones, and unusual structures. They can also report new equipment and whether engineer material such as lumber, gravel, or building stone or quarry sites are in an area. No special training is required for personnel to make these and many other observations. However, the person must be told what is expected of him and how to transfer this information to someone knowledgeable who can disseminate it through proper channels, even to the Defense Intelligence Agency (DIA) if appropriate. Thus, each individual contributes to the collection of engineer intelligence and thereby strengthens his unit and the Army as a whole. The importance of the individual to intelligence cannot be over-emphasized.

22. The Imagery Interpreter

a. A great amount of engineer intelligence is made available through the efforts of the imagery interpreter, who uses a variety of equipment and techniques to identify, analyze, and measure both natural and manmade features from current types of image-producing sensors such as the camera, infrared detector, and radar. Where personnel on the ground may have difficulty pinpointing openings in a large forested area, the imagery interpreter may identify the openings with ease. Ground reconnaissance of a road network may take days to perform, but by using aerial photographs of the area, the job may be accomplished in hours. In areas inaccessible on the

ground, the required engineer information may be obtained by airborne photographic, infrared, or radar sensors.

b. The imagery interpreter does not depend on his equipment and skill alone to make complete analyses. He has supporting data to provide him with information necessary to make accurate interpretations. Without at least some data from ground observers to supplement the imagery, the imagery interpreter may, in some cases, be able to report only that an unidentifiable "something" is located at a particular place.

23. Ground Reconnaissance

a. *Mission.* Ground reconnaissance is undertaken by personnel of all arms, including engineers, to obtain specific information. Some units are especially organized and designated to perform ground reconnaissance. The ability to obtain timely information by this and other methods depends largely on the reconnaissance units' mobility, means of communication, training, and control.

b. *General Principles.*

- (1) Reconnaissance should be preceded by a review of available pertinent intelligence, maps, and aerial photographs.
- (2) Any reconnaissance on which engineer work is to be based should be made far enough in advance to permit planning the work and starting it on schedule.
- (3) Incomplete but timely information is useful, whereas a complete report received too late to be acted upon is worthless.
- (4) Reconnaissance must be repeated as often as is necessary to keep the information up to date. In fast-moving situations and in combat it may be continuous.
- (5) Aerial reconnaissance, if means are available, should precede ground reconnaissance.

c. *Responsibility.* Every staff engineer and engineer commander is responsible for the reconnaissance needed by his command. He normally delegates to his intelligence officer the planning and direction of the reconnaissance.

d. *Echelons.* From front to rear, these are—

- (1) Engineer aerial reconnaissance.
- (2) Advanced ground reconnaissance, by engineer personnel with advance or covering forces.
- (3) Division area reconnaissance, by divisional engineer troops.
- (4) Rear area reconnaissance, as directed by corps, army, and lines-of-communication engineers.

e. *Planning.* The officer ordering the reconnaissance prepares orders setting forth the mission of the reconnaissance party. The order includes a statement of where the area to be reconnoitered is located; what data are desired, in what detail, and in what order of importance; when, where, and to whom the chief of party is to make his report; and any other required instructions. The officer responsible for conducting the reconnaissance decides on the general route, taking into consideration enemy observation and interference; prepares a time schedule; and selects the necessary equipment and qualified personnel. The reconnaissance plan must be coordinated with the unit which has area responsibility. Figure 1 shows an engineer reconnaissance checklist which is used for requesting reconnaissance. It is issued by the headquarters of an engineer combat battalion to one of its companies. Though reconnaissance usually has a specific mission, personnel should be alert for other intelligence or information.

f. *Conduct.*

- (1) *Observing.* Attention to detail is important. Quantities, sizes, and other data expressible in numbers should be counted, measured, or estimated.

RECONNAISSANCE INSTRUCTIONS

NO. _____

 (Organization)
TO: _____ **Effective** _____
 (Hour and Date)

MAPS _____

Complete report to _____ at _____
 (Organization) (Place, Time, and Date)

<p>Reconnoiter and report information as indicated below by items checked. Report also any other information; of technical importance incidentally secured.</p>	<p>DETAILED INSTRUCTIONS Areas, special features or structures special reports/and work estimates required.</p>
<ol style="list-style-type: none"> 1. ROADS: Classify using symbols. 2. BRIDGES, FORDS AND FERRIES: classify using symbols. Possible by-pass for existing crossings. 3. BUILDINGS: especially those suitable for use. 4. OBSTACLES TO OUR MOVEMENT: natural and artificial: include demolitions, mines, booby-traps, vertical obstructions. 5. TERRAIN: general nature, ridge system, drainage system including fordability, forests, swamps, areas suitable for mechanized operations. 6. UNDERGROUND FEATURES: caves, tunnels. 7. ENGR MATERIALS: particularly road material, quarries, bridge timbers, lumber, steel, explosives. 8. ENGR EQUIPMENT: rock crushers, sawmills, garages, machine shops, blacksmith shops, etc. 9. ERRORS AND OMISSIONS ON MAPS USED. 10. BARRIERS TO ENEMY MOVEMENT: natural, artificial and sites for construction of improvement. (work estimates) 11. WATER POINTS: recommended locations. 12. STREAMS: general description, width, depth, banks, approaches, character of bottom and means to be used at possible crossing sites. Navigability? 13. DEFENSIVE POSITIONS. 14. BIVOUAC AREAS: entrances, soil, drainage, sanitation, concealment. 15. PETROLEUM STORAGE AND EQUIPMENT. 16. UTILITIES: water, sewage, electricity, gas. 17. PORTS: wharves, sunken obstacles, cargo handling facilities, storage facilities, transportation routes. 18. CONSTRUCTION SITES: Drainage, water supply, power source, earthwork, access, acreage, soil. 19. NUCLEAR AND DEFILADE POSITIONS. 	

BY ORDER OF _____

Figure 1. Engineer reconnaissance checklist.

ENGINEER RECONNAISSANCE REPORT		PAGE 1 OF 4 PAGES	
TO: CO: 21 ST ENGR BN		FROM: CO A 21 ST ENGR BN.	
FILE NO.	PARTY LEADER (NAME, GRADE, ORGANIZATION)	PLACE - HOUR - DATE	
	THOMAS P TAYLOR 2d LT	UT 586708	
REPORT NO. 1	COA 21 ST ENGR BN.	11 2000 MAR 65	
MAPS QUANTICO, VIRGINIA 1:50,000 SHEET 5561 III			
DELIVER TO (Organization, Place, Hour and Date)			
S2: 21 ST ENGR BN. UT 55646Z 12 0200 MAR 65			

ADDITIONAL REMARKS AND SKETCH

UT 058689 - LOG POST OBSTACLE BLOCKING RT 132

SKETCH

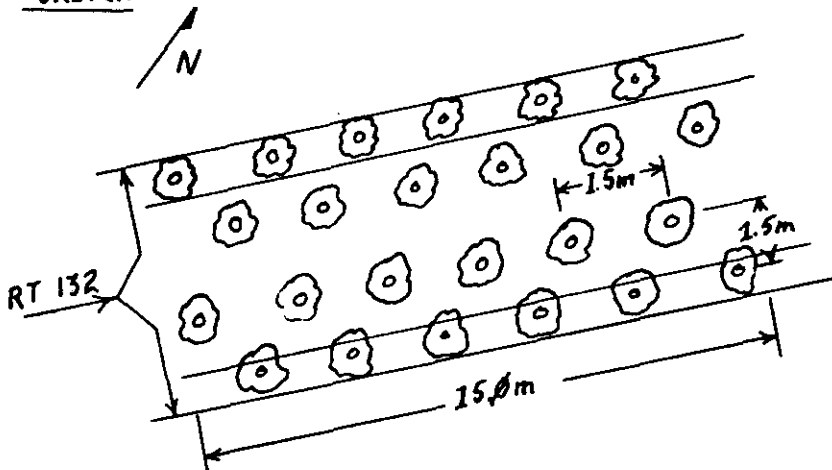

(24) LOG'S @ 0.5m. DIAMETER, C-C 1.5m.
ON ALL SIDES, 1.5m. TO 2.5m. ABOVE GROUND



KEY	OBJECT	TIME OBSERVED	WORK ESTIMATE?
1	X	0900	YES

ENGINEER WORK ESTIMATES ON OTHER SIDE

TYPED NAME, GRADE AND ORGANIZATION	SIGNATURES
THOMAS P TAYLOR 2d LT.	Thomas P Taylor
COA 21 ST ENGR BN.	

DA Form 1711-R, 1 Jun 61

Edition of 1 May 56 is obsolete.

Figure 2. Engineer Reconnaissance Report (DA Form 1711-R).

ENGINEER RECONNAISSANCE REPORT		PAGE 2 OF 4 PAGES	
TO: CO: 21 ST ENGR BN		FROM: CO: CO A 21 ST ENGR BN	
FILE NO.	PARTY LEADER (NAME, GRADE, ORGANIZATION)	PLACE - HOUR - DATE	
	THOMAS P. TAYLOR 2d LT	UT 586708	
REPORT NO. 1	COA 21 ST ENGR BN	11 2000 MAR 65	
MAPS <u>QUANTICO, VIRGINIA 1:50,000 SHEET 5561 III</u>			
DELIVER TO (Organization, Place, Hour and Date)			
S2: 21 ST ENGR BN UT 556961 12 0100 MAR 65			

				ADDITIONAL REMARKS AND SKETCH
KEY	OBJECT	TIME OBSERVED	WORK ESTIMATE?	
1	X	-	-	<p>CONT.</p> <p><u>OBSTACLE NOT DEFENDED:</u></p> <p><u>BYPASS: DIFFICULT (S^WM^Y) DUE TO SWAMPY TERRAIN</u></p>
2	X	0920	NO	<p><u>UT 509686 - GRAVEL PIT IN OPERATION</u></p> <p><u>QUANTITY: APROX. 6,000 YD³ STOCKPILED RANGING FROM 1 IN. TO 3 IN. IN DIAMETER</u></p> <p><u>TYPE: CRUSHED GRANITE</u></p> <p><u>COMMUNICATIONS: GOOD ACCESS ROADS WITH AMPLE SPACE FOR TURN AROUND AND LOADING.</u></p>
3	W	0940	NO	<p><u>UT 50974 - ABANDONED ENEMY EQPT.</u></p> <p><u>QUANTITY & TYPE: (2) "ZIPLO" MODEL 200 CRAWLER CRANES. (OPERATIONAL)</u></p> <p><u>CHECKED FOR BOOBY TRAPS - NONE</u></p>

ENGINEER WORK ESTIMATES ON OTHER SIDE	
TYPED NAME, GRADE AND ORGANIZATION	SIGNATURES
THOMAS P TAYLOR 2d LT	Thomas P. Taylor
COA 21 ST ENGR BN	

DA Form 1711-R, 1 Jun 61



Edition of 1 May 56 is obsolete.

Figure 2 — Continued.

(2) **Recording.** Reconnaissance data should be recorded immediately by notes, charts, pictures, overlays, or

sketches, or on prepared forms. DA Form 1711-R (fig. 2) is an Engineer Reconnaissance Report and will be

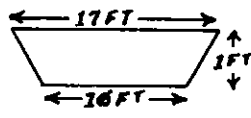
ENGINEER RECONNAISSANCE REPORT		PAGE 3 OF 4 PAGES	
TO: CO: 21 ST ENGR BN		FROM: CO: COA 21 ST ENGR BN	
FILE NO.	PARTY LEADER (NAME, GRADE, ORGANIZATION)	PLACE - HOUR - DATE	
REPORT NO. 1	THOMAS P. TAYLOR 2 ^{LT} COA 21 ST ENGR BN	UT 586708 11 2000 MAR 65	
MAPS <u>QUANTICO, VIRGINIA 1:50,000 SHEET 5561 III</u>			
DELIVER TO (Organization, Place, Hour and Date) <u>S2: 21ST ENGR BN UT 556461 12 0100 MAR 65</u>			

KEY	OBJECT	TIME OBSERVED	WORK ESTIMATE?	ADDITIONAL REMARKS AND SKETCH
4	BIV AREA	1035	NO	<p>UT 512692 - POSSIBLE BIVOUAC AREA</p> <p>SIZE: 700m X 900m</p> <p>COMMUNICATIONS: GOOD ACCESS ROAD W/GOOD DRAINAGE & HARD SURFACE</p> <p>SITE CONDITIONS: GOOD DRAINAGE WITH FIRM SOIL, GOOD CK, GOOD OBSERVATION & F/F</p>
5	(F)	1150	NO	<p>UT 558680 - POSSIBLE WATER POINT</p> <p>QUANTITY: $Q = AV6.4$ $A = 13.5 \text{ FT}^2$ $V = 35 \text{ FPM}$ $Q = (13.5)(35)(6.4) = 3,012 \text{ GPM}$</p> <p>QUALITY: CLOUDY, NO ODOR, NO OBSERVED SOURCE OF POLLUTION, SPL WAS TAKEN FOR TESTS</p> <p>COMMUNICATIONS: GOOD ACCESS RDS FROM MSR, GOOD TURN AROUND & PARKING ON SITE</p> <p>SITE CONDITIONS: GOOD, SLOPE OF BANKS 5%, BIVOUAC AREA ON SITE FOR W.P. TEAM, BRIDGE POSSIBLE ARTILLERY TARGET</p>  

ENGINEER WORK ESTIMATES ON OTHER SIDE	
TYPED NAME, GRADE AND ORGANIZATION THOMAS P. TAYLOR COA 21 ST ENGR BN	SIGNATURES <i>Thomas P. Taylor</i>



DA Form 1711-R, 1 Jun 61

Edition of 1 May 56 is obsolete.

Figure 2 — Continued.

locally reproduced on 8- by 10½-inch paper. Figure 3 shows a Bridge Reconnaissance Report (DA Form 1249).

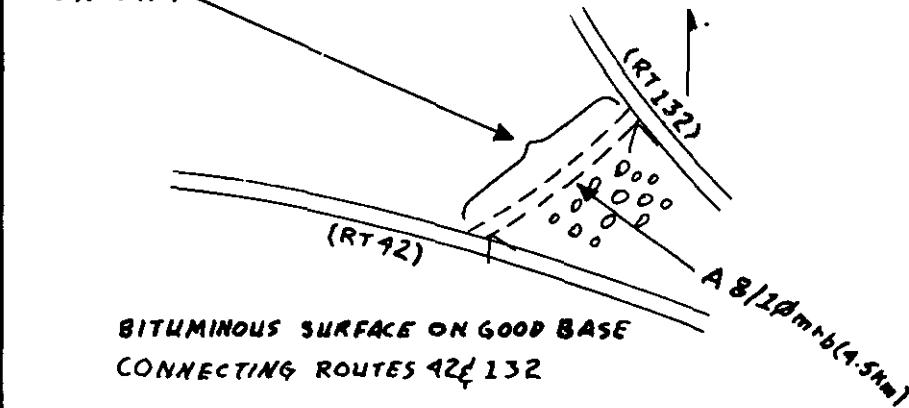
Intelligence may also be recorded on maps and photographs.

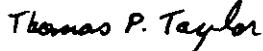
ENGINEER RECONNAISSANCE REPORT			PAGE 4 OF 4 PAGES		
TO: CO: 21ST ENGR BN		FROM: CO: COA 21ST ENGR BN			
FILE NO.	PARTY LEADER (NAME, GRADE, ORGANIZATION)		PLACE - HOUR - DATE		
REPORT NO. 1	COA 21ST ENGR BN		UT 586708 11 2000 MAR 65		
MAPS QUANTICO, VIRGINIA 1:50,000 SHEETS 5561 III					
DELIVER TO (Organization, Place, Hour and Date) S2: 21ST ENGR BN UT 556461 12 0100 MAR 65					
ADDITIONAL REMARKS AND SKETCH					
KEY	OBJECT	TIME	OBSERVED	WORK	ESTIMATE?
6 	MAP ERROR	1200	NO	NO	NO
<p>UT 557963 TO UT 558003 ROAD NOT SHOWN ON MAP</p>  <p style="text-align: center;">BITUMINOUS SURFACE ON GOOD BASE CONNECTING ROUTES 92 & 132</p>					
7 	Y 	1230	NO	NO	NO
<p>UT 761432 EXISTING WATER PURIFICATION PLANT SUPPLYING WATER TO THE CITY OF YUCC</p> <p>OUTPUT 50,000 GAL PER DAY</p>					
ENGINEER WORK ESTIMATES ON OTHER SIDE					
TYPED NAME, GRADE AND ORGANIZATION			SIGNATURES		
THOMAS P. TAYLOR 2d LT					
COA 21ST ENGR BN					

DA Form 1711-R, 1 Jun 61

Edition of 1 May 56 is obsolete.

Figure 2 — Continued.

ENGINEER WORK ESTIMATE

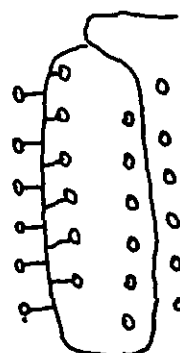
LOCATION KEY	DESCRIPTION OF WORK	UNIT REQ'D	HOURS	EQUIPMENT		MATERIALS				
				TYPE	NO.	HOURS	TYPE	UNIT	QUANTITY	
$P = \frac{0^2 - (19.2)^2}{4\theta} = \frac{-368.64}{4\theta} = -9.3\theta$ $\circ \circ 1\theta \# / \text{POST}$ $24\theta \# \text{ TOTAL}$	REMOVE LOG POST FROM ROUTE 132 BY DEMO 	1 SQUAD	2	DEMO SET #1	1	2	TNT	#	240	
				D-7 CAT	1	2	D-CORD	FT	140	
								NON ELECT CAPS	EA	25
								TIME FUSE	FT	4
								M-2 FUSE LIGHTER	EA	1

RECONNAISSANCE REPORT ON OTHER SIDE

Figure 2 — Continued.
 (Work estimate (reverse of DA Form 1711-R.))

BRIDGE RECONNAISSANCE REPORT (FM 5-16)										DATE	SIGNATURE								
TO: (Headquarters ordering reconnaissance) COMMANDING OFFICER, ATTN: 52 21 ST ENGR BN (21 ST INF DIV)										1 Jun 1964	John H. Doe.								
MAP: (Country, scale and sheet number or name) Virginia, Annapolis, 1:25000; Sheet 5561										FROM: (Name, grade, and unit of officer or NCO making reconnaissance) John H. Doe, 1st Lt. Co A 21st ENGR BN									
										DATE/TIME GROUP (Of signature) 011900Z									
SERIAL NO.	LOCATION	CLEARANCE				SPANS				ESSENTIAL BRIDGE INFORMATION				ADDITIONAL BRIDGE INFORMATION (Add columns as needed) (Military load class, overall length, roadway width, vertical clearance, bridge by-pass)				Remarks	
		HORIZONTAL	UNDER BRIDGE	NUMBER	TYPE OF CONSTRUCTION	TYPE OF CONSTRUCTION	TYPE OF MATERIAL	LENGTH AND CONDITION	OVERALL LENGTH	Travelled width	Overhead clearance	Military Load Classification	Overall length	Travelled width	Overhead clearance	Bridge By-Pass	Remarks		
1	LA 072687	00	6ft.	1	3	h	13.5F(w)	9	14FT	12 FT	00	13	14	14	13	12	12	Easy	NONE
2	LA 118759	9.5m	6.5m		4	K	4 m	40 50 ↑↑	25m	7.5m	4m							Difficult.	NONE
3	LA 165650	00	23	5	3	ak	25m	80 60 ↑↓	126m	12	00							Impossible	NONE
4	LA 156643	10.5	8.5	3	6	K	10 m	80 100 ↑↓	100m	10	10.5m							Impossible	NONE

PREVIOUS EDITION OF THIS FORM IS OBSOLETE.

DA FORM 1 JUL 60 1249

Figure 3. Bridge Reconnaissance Report (DA Form 1249).

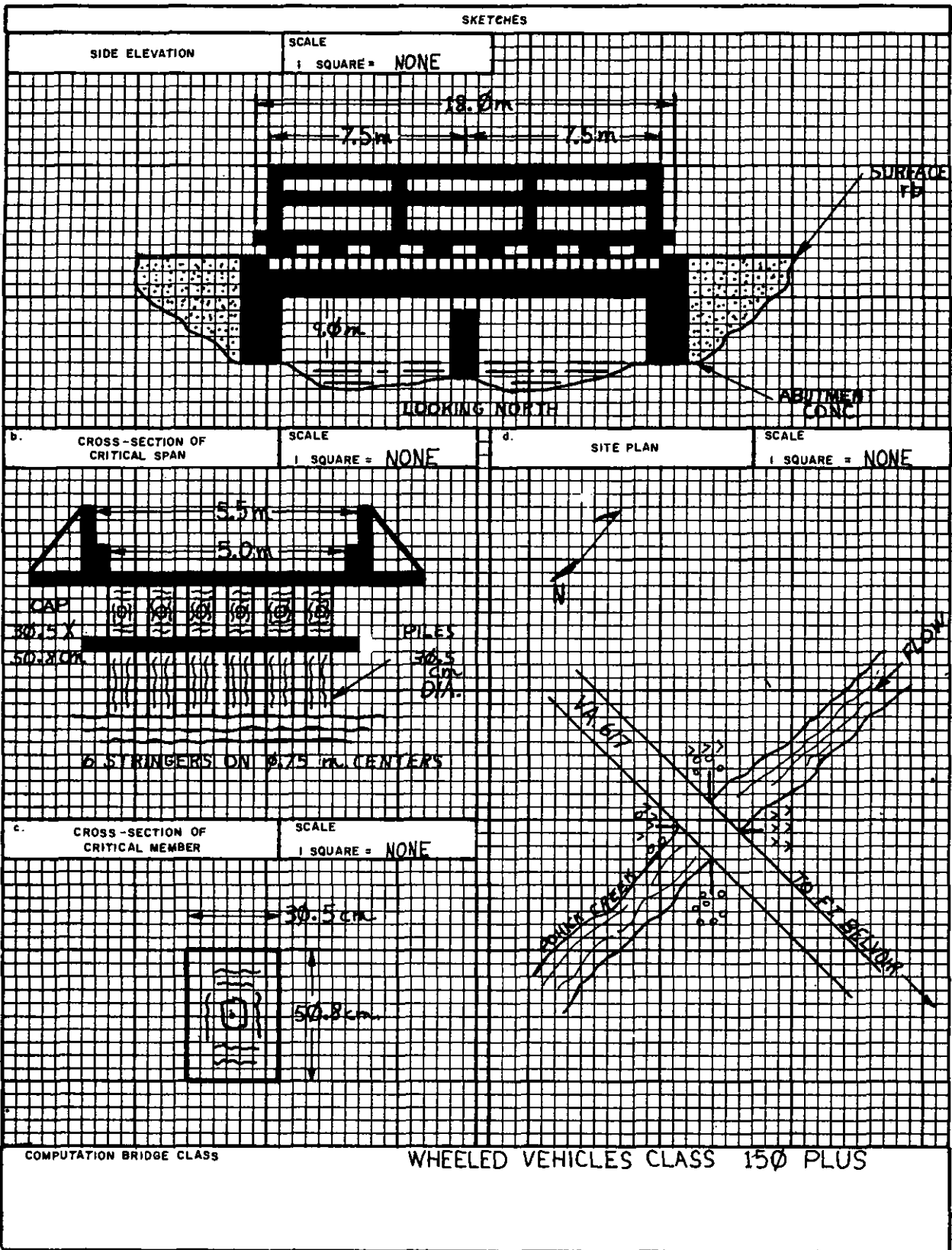

Figure 3 — Continued.
(Bridge sketch (reverse of DA Form 1249)).

- (a) Maps are one of the most valuable intelligence documents and sources of information. They are convenient for recording information, making changes, and adding omissions.
- (b) Photographs are an important source of information and intelligence which can be easily collated, disseminated, and filed. Often they are the only record of information available. Pictures should be taken from different angles to show all pertinent points. An appropriate scale or other form of measurement should be included to assist the analyst and others in interpreting the photograph. The location of the object or area photographed can be keyed to a map or overlay. Photographs are also an excellent medium for noting and correcting errors on maps. All photographs should be dated.
- (3) *Scheduling.* Adherence to schedule by the reconnaissance party is necessary in order to avoid going too fast and missing important items, or going too slow and either missing the deadline for the report or omitting part of the reconnaissance. The use of control points, at which the party must arrive by predetermined times, is often valuable.
- (4) *Avoiding detection.* The reconnaissance party must avoid being detected by the enemy and should not engage in combat unless it is necessary to accomplish the mission.

g. Other Aspects of Ground Reconnaissance. For further details on planning and conducting ground reconnaissance, see FM 5-1, FM 5-36, FM 21-75, FM 30-5, and FM 30-10.

24. Aerial Reconnaissance

a. Basic Principles. The basic principles governing aerial reconnaissance are the same for ground reconnaissance. The two supplement each other and are most effective when they can be parts of a coordinated information collection plan, although either one may be, and often is, used independently. Aerial recon-

naissance gives rapid coverage, a more or less simultaneous picture of a large area, and a view of areas which are inaccessible to ground observers. Poor weather conditions impair its effectiveness. Visual aerial reconnaissance is also affected by poor visibility and by the distance from which an area is viewed. Aerial reconnaissance cannot give certain details provided by ground reconnaissance. Some matters of interest, such as the interiors of structures and the objects concealed by adequate natural cover or camouflage, are beyond the capability of aerial observation.

b. Categories. With respect to technique, aerial reconnaissance missions are typed according to the sensing equipment used—photographic, electronic, and weather. With respect to areas studied, there are five types of visual aerial reconnaissance—area search, specific search, route reconnaissance, contact reconnaissance, and artillery adjustment. Engineer aerial reconnaissance is limited to the first three.

- (1) *Area search.* This corresponds to general ground reconnaissance and is concerned with all items of engineer interest in a given area. It is most successful in territory which is not heavily wooded or extremely precipitous.
- (2) *Specific search.* This corresponds to special ground reconnaissance and is intended to develop information on some particular installation, activity, or object of interest.
- (3) *Engineer route reconnaissance.* This deals with roads, railroads, and waterways, including especially the facilities, installations, and equipment concerned with transportation, but embracing also any other relevant items along the route.

c. Aircraft Reconnaissance. The engineers are supported by Army aviation elements which supply the reconnaissance required to accomplish specific missions. This is supplemented by the Air Force and Navy/Marine Air reconnaissance. Staff engineers, especially at higher headquarters, may arrange with the Air Force for special or long-distance reconnaissance missions. Navy and Marine Corps air recon-

naissance support is normally used in amphibious operations.

d. Conduct of Visual Reconnaissance. Engineer visual aerial reconnaissance should be performed by trained observers. The training of an adequate number of observers is the responsibility of the unit intelligence officer. Initial reconnaissance of an area, which is carried out to obtain general data on terrain, routes of communications, and other matters of engineer interest, is usually done by the engineer intelligence officer or section. It is the basis upon which he plans specific search missions and route reconnaissance missions, and is also the basis for his ground reconnaissance planning. Aerial reconnaissance, especially of areas not visible to ground observers, must be repeated periodically to detect any changes.

25. Aerial Photography and Photointerpretation

a. Sources of Aerial Photographs. Staff engineers and engineer commanders may obtain aerial photographs, for other than mapping purposes, from the following source:

- (1) *Photography taken by engineer observers.* Although the aircraft used do not have built-in cameras, trained photographers can produce good quality photographs with stereoscopic capability.
- (2) *Duplicate prints from the photointerpretation teams of intelligence officer.* These prints are reproduced from various sources, including those from intelligence officers of higher commands and those taken by organic aircraft of the command.
- (3) *Air Force photos.* Some photos are made by the Air Force especially for the engineer. These are requested through channels by the theater commander or G2.

b. Coverage. In tactical aerial reconnaissance an initial coverage is made to obtain information on terrain, trafficability, and other features of interest to engineer intelligence agencies. A second coverage may be made to determine current data, and a third to acquire data on specific objects or objectives.

c. Capabilities and Limitations.

- (1) The major advantages of photographs over visual observation are that they are permanent records mechanically accurate (except for optical distortions) and that they show all detail. They can also be taken at night and through clouds and fog and be studied by specialists with the aid of magnifying and stereographic devices.
- (2) Disadvantages of photographs are that poor exposures are possible; photographs show only the surface (not what is under heavily wooded terrain nor the engineering properties of terrain); and single photographs may not reveal motion.

d. Imagery Interpretation.

- (1) The primary agency for imagery interpretation in a command is the imagery interpretation section of the intelligence detachment. At field army level, imagery interpretation functions are performed by the Military Intelligence Battalion Air Reconnaissance Support (MIBARS) and within the field army headquarters itself by image interpreters organic to the Military Intelligence Battalion Field Army. Aerial photographs which the staff engineer obtains from the G2 will normally have been interpreted and an imagery interpretation report prepared.
- (2) Some of the information which enters into engineer intelligence can be obtained from aerial imagery. It should be recognized, however, that image interpreters may have had only a limited amount of experience in the recognition of engineer equipment and functions. A coordinated effort by engineer personnel and imagery interpreters may be required to extract the maximum information from aerial photography. The staff engineer can arrange, through the G2 Air, for prints of any photographic mission for detailed study by engineer units.

e. Aerial Imagery. For normal military use, vertical and oblique photographs taken with

single-lens cameras and panoramic cameras are standard. Panchromatic film (black and white) is the primary film used in these cameras. Special films, such as color, camouflage detection, and infrared, can be used in these cameras to meet special requirements. Other cameras, such as sonne' strip and composite are used for special purposes. As a supplement to conventional aerial photography, imagery produced by side-looking airborne radar (SLAR) and infrared (IR) sensors are available in the field. Aerial photography is used to produce map supplements such as mosaics pictomaps, and photomaps.

- (1) *Composites*. Vertical and oblique photographs are developed into composites. A composite photograph is printed from three or more negatives which are exposed simultaneously by a multilens camera.
- (2) *Sonne'*. The sonne' camera has no shutter but photographs a continuous strip of terrain on a sensitized film that moves continuously across a fixed slit.
- (3) *Mosaics*. A mosaic of aerial photographs consists of two or more photographs arranged to give a continuous picture of an entire area.
- (4) *Photomaps*. A photomap is a reproduction of a photograph or mosaic upon which grid lines, marginal data, and place names have been added. Normally, the military photomap is a map-size reproduction of a controlled mosaic which shows no relief.
- (5) *Pictomaps*. The pictomap is a photo image base on which the cultural, planimetric, and topographic information has been surprinted. The photographic base is improved by adding shades and color tones to accentuate vegetation, open areas, and the shadows caused by relief. This process develops the photomap-type product into a more legible map substitute which is easier to read (FM 21-26 and FM 21-31).
- (6) *Panoramic photography*. In panoramic photography the resulting image is a

"sweep" presentation of the terrain, usually from horizon to horizon, and perpendicular to the line of flight. This has the appearance of a left and right oblique separated by vertical exposure with no lines of demarcation. Panoramic cameras are also used in the forward oblique position and give a forward panoramic view of the terrain which is useful in briefing pilots on the approach into an area.

- (7) *Color photography*. Color photography is especially useful in the identification of soil types, vegetation, rock outcrops, and industrial stockpiles. Color photography has good water penetration capabilities and is useful in the recognition of underwater obstacles and in depth determination. There are two types of color photography, the standard type and infrared.
- (8) *Camouflage detection photography*. Camouflage detection film images natural broad-leaf foliage in a reddish color while infrared absorbing materials, such as paints that are used to simulate foliage and narrow-leaf foliage, such as coniferous trees, appear purplish or bluish in color.
- (9) *Infrared photography*. Infrared photography is produced with a conventional camera system by using a black and white film which is sensitive to reflected infrared instead of to visible light. The images are produced by a heat reflectivity process which is able to depict the difference between wet and dry surface and artificial camouflage material. This film also has excellent haze penetration capabilities. The infrared sensor measures the emitted infrared from the terrain and objects on the terrain and records this emission on aerial film. The result is a thermal difference image which looks like a low-grade photograph. Hot vehicle motors, fires, and other heated objects are recorded as hot spots on the imagery.

(10) *Side-looking airborne radar imagery.* Side-looking airborne radar produces a map-like presentation of the terrain by recording the radar reflectance on aerial film. Because of the low resolution of the resulting imagery, special interpretation techniques are required to extract information.

26. Interrogation

Interrogation in general is not an engineer function, except for information obtained by individuals through contact at the operational level. Information obtained must be carefully identified as to source and reported to the intelligence officer. Engineer personnel often assist intelligence agencies in interrogating enemy personnel and civilians in matters that pertain to engineering.

27. Enemy Documents

a. Definition. From the intelligence viewpoint, an enemy document is any form of recorded information on the enemy nation and its armed forces which originated from enemy sources. The term includes enemy-produced books, periodicals, scientific and technical reports, and the like, which are important sources of information. National-level intelligence is produced by the Defense Intelligence Agency (DIA). At field army and lower levels, the enemy documents most commonly encountered at first hand by engineer agencies are those found on enemy dead or prisoners and at captured headquarters and other record-keeping agencies. These include diaries, letters, and other personal documents, and also official material such as maps, orders, reports, organizational records, and military and civilian publications.

b. Handling. In a divisional area, captured enemy documents ordinarily are found by combat elements, including engineers. Everyone must be indoctrinated and trained to turn all documents in to his immediate superior, who in turn sends the material to the appropriate intelligence officer or agency.

28. Materiel

a. Enemy engineer materiel is usually found or captured by troops in combat who bring it

to the attention of their immediate superior. He reports it to the unit intelligence officer who forwards it through intelligence channels. Corps technical intelligence collection teams also contact combat elements and collect the enemy materiel. These collection teams are usually located near combat units because they are constantly looking for technical materiel and information. A special technical unit evaluates specific pieces of materiel and assists in developing the intelligence as required.

○

TO BE AFFIXED TO CAPTURED
ENEMY EQUIPMENT

DO NOT DISTURB

NOMENCLATURE: _____
 SERIAL NO: _____
 DATE CAPTURED: _____
 WHERE CAPTURED: _____
 CAPTURING UNIT: _____
 CIRCUMSTANCES OF CAPTURE: _____

 CONDITION: _____

NOTICE

THIS EQUIPMENT IS BEING
HELD FOR:

ANALYSIS
 UTILIZATION
 SALVAGE
 DESTRUCTION

BY AUTHORITY OF JOINT/
 UNIFIED/THEATRE/FIELD
 ARMY COMMANDER:

 (Signature)

 (Unit)

DO NOT DISTURB

(DO NOT DISTURB)
 (In language of area of operations)

PROPERTY OF THE UNITED STATES GOVERNMENT

CAPTURED EQUIPMENT

Figure 4. Equipment marking tag.

b. A tag which is produced locally (fig. 4) is securely attached to captured enemy materiel to facilitate identification, shipping and further analysis. These tags accompany the item to its final destination. (See para 45-48, FM 30-16 for details.)

29. Reporting Information

a. *Channels.* An agency which has been ordered to obtain engineer information of any sort makes its report to the officer who gave the order (or to any agency which the order may specify). If he is not a member of a processing agency, he transmits it to the appropriate intelligence officer for processing. This statement must be qualified in combat and other fast-moving or remote situations, when information may have to be acted on at the level received, or at a higher command level, before there is time for formal processing.

b. *Form of Report.* Due to the wide variations that exist in the nature of engineer information and the use to be made of it, no form can cover all situations. Some typical forms used to report engineer ground reconnaissance are DA Form 1711-R, DA Form 1249, and DD Form 1396.

30. Scope and Direction of the Collection Effort

a. Direction of engineer intelligence work is concerned with the collection, processing, and dissemination of intelligence. Collection involves the following:

- (1) Determining the essential elements of information (EEI).
- (2) Preparing a collection plan.
- (3) Issuing orders and requests for information to agencies and keeping a continuous check on these agencies.
- (4) Developing, maintaining, and disseminating an item-wanted list which includes technical items and other engineer intelligence.

b. Direction of the collection effort of engineer information at any level of command is in the hands of the engineer of the command, subject to the commander's policies and the supervision of the intelligence officer.

31. Engineer Essential Elements of Information

a. *Definition.* An essential element of information (EEI) is a critical item of information or intelligence regarding the enemy and the area of operations needed by the commander before he can arrive at a sound decision. The decisions pertain to the mission of the command and the choice of the course of action required to accomplish the mission. Engineer EEI are highest priority intelligence requirements essential to the commander in making decisions which involve terrain, meteorological and hydrographic conditions, and other engineer information. Priorities reflect the criticality of the need for the particular information by a specific commander. No formula exists that can automatically determine priorities. An intelligence priority in one situation or for one command may not be a priority in another situation or for another commander.

b. *Origin of EEI's.* EEI's may originate either with the commander or within the staff in the form of recommendations. The recommendations are coordinated and presented for command approval by the intelligence officer. An item of information or intelligence specified in the unit SOP for collection or dissemination may become an EEI. For example, an SOP may require all units to report items on known or suspected targets suitable for nuclear attack or indications of their existence or development. It becomes an EEI if it is needed by the commander at a particular time in making an important decision.

32. Designation of Engineer EEI

a. The designation of engineer and other EEI is a responsibility of the commander, assisted by his staff, principally the intelligence officer.

b. The recommendation of appropriate engineer EEI to the intelligence officer, for approval by the commander, is a responsibility of the staff engineer, and one which, in the absence of a specific directive, he must undertake on his own initiative. In this task he relies largely on the intelligence section of his office.

c. The intelligence officer, in addition to the needs of his own command, may receive calls from a higher echelon of command for items

of engineer intelligence or information needed at that level. If such items are not already available, he instructs the staff engineer to add them to his collection plan. Similar calls may come to the intelligence officer through intelligence channels, or to the staff engineer through technical channels, from lower echelons.

d. When engineer EEI have been announced, they of course guide the activities of agencies which collect engineer information. However, those agencies should also collect and transmit any other information which comes to their attention and appears to have a bearing on the situation.

33. Collection Plan

a. *Content of Plan.* The engineer or his intelligence officer prepares a collection plan, based on his list of EEI and other requirements for engineer intelligence and information. This is an aid and is not disseminated. There is no rigidly prescribed form for a collection plan. Normally it will contain the following:

- (1) The unit for which the information is being collected.
- (2) The period.
- (3) A tabular list of EEI.
- (4) If necessary an analysis (*b* below) of each item of the EEI, to determine what specific indications (clues to the answer) the collecting agency should look for.
- (5) A tabulation of the agencies which are to be instructed to collect each item of information.
- (6) A notation of when and where each agency is to submit its report.

b. *Analysis of Items of EEI.* Whether this is necessary in any given case will depend in part on the nature of the item. Thus, if information is desired on enemy activities in a particular area or directed to a particular end, the agency preparing the collection plan, having a background of previous intelligence, may know that certain specific indications would have a bearing on the problem. These should be entered on the collection plan, with a notation of the corresponding instructions to be given the collecting agency. If the EEI are factual data on terrain, construction materials and equipment, and the like, as engineer EEI more commonly are, such analysis is often needless.

However, the skill and experience of the collecting agency and its knowledge in specialized fields must be taken into account. For example, when seeking information on the stability of a stretch of bank along an alluvial river where a water-supply intake or bridge abutment is contemplated, there are certain physical indications of bank stability or instability with which an ordinary engineer reconnaissance party, unless it included a hydraulics specialist, might not be familiar.

c. *Selection of Agencies.* In deciding on the agencies to collect EEI, care must be taken to select, in each case, those best qualified for the task by training and location, and also to balance the load fairly among them with regard to their other duties. In general it is better to assign at least two agencies to each item of EEI.

d. *Timing of Reports.* A report may be called for at a specific time, periodically, or as the information is obtained.

e. *Extent of the Plan.* The extent, detail, and formality of a collection plan will vary with the level of command. Thus, in a combat company it might be a brief pencilled notation, whereas at field army level or higher it might be a detailed formal document.

- (1) For additional information on collecting combat information, see FM 30-5.
- (2) Figure 5 shows a collection plan prepared by S2 of a divisional engineer battalion, for collecting certain EEI for division headquarters and the battalion. The assumed situation is that of a division planning a river crossing. The division has three brigades in line, each of which has a sector of the front and has a lettered engineer company, supporting it. Our troops hold the ground on the south side of the river, although small groups of the enemy may still be concealed there. Division G2 has called on the engineer battalion for data on crossing sites, road conditions, and the like. The battalion S2 incorporates these, as EEI, into his collection plan, adding other items, such as the location of construction materials which are of interest to his battalion. He then notes, with check

marks (X), what agencies are in a position to obtain the information; and after study, circles the check marks for the agencies which he decides to call on. Suitable orders to those agencies are then issued. Since the EEI are factual data of a type familiar to all trained engineer personnel, an analysis (b above) is necessary. No needless material is placed on the plan. For example, the lettered

companies know the limits of their respective sectors, which therefore do not have to be specified in the plan or the orders. Again, the selection of crossing sites will involve the use of the aerial reconnaissance plane, probably by S3 and the reconnaissance officer, to make a tentative selection of sites, followed by ground reconnaissance. Instructions to this effect, however, would be needless even in the

Unit: 1st Engr Bn Information required in connection with proposed river crossing By: Bn S2 For: Div G2, Bn hq Area to be studied: Triangle SHARON—PETERSVILLE— ALLIANCE bounded by State roads 106, 107, and 88 Limiting hour and destination of reports: 191730 Jul 57; Bn S2	Agencies (Check agencies to be employed)									
	Request corps engr	Asst div engr	S2	S3	S4	Co A	Co B	Co C	Bn reconn. off	Liaison plane
Essential elements of information										
1. What are the sites on PEMBERTON RIVER between WAVERLY and NORTH SHARON suitable for: (1) assault boat crossings, (2) footbridges, (3) ferries, and (4) ponton bridges (three alternative sites for each)?				X		X	X	X	X	X
2. What in detail is the condition of: (1) the SHARON-WAVERLY road (State 106), (2) the SHARON-NORTH SHARON road (State 107), and (3) all roads between them?						X	X	X		
3. What information is obtainable on (1) the WAVERLY-ALLIANCE road (State 106), (2) the NORTH SHARON-PETERSVILLE road (State 107), and any roads that the enemy may have built in the area between State road 88 and the PEMBERTON RIVER; including information on the partially destroyed bridges over the river, at WAVERLY and NORTH SHARON?	X	X							X	X
4. What natural cover, and what natural concealment, are available along both sides of the PEMBERTON RIVER between WAVERLY and NORTH SHARON?		X	X			X	X	X	X	X
5. What are suitable locations for supply points, between State road 88 and the PEMBERTON RIVER, for dumping fortification materials to be used in organizing our position after the crossing?					X				X	X
6. What enemy minefields can be identified?		X							X	
7. What are suitable sites for minefields and roadblocks to be placed by our troops, while organizing the position after the crossing?			X			X	X	X	X	X
8. What are the locations and amounts of any engineer construction materials, especially sand, gravel, crushed stone, and milled lumber, suitable for use in the repair and construction of roads and bridges?	X	X			X	X	X	X		

Figure 5. A collection plan of an engineer battalion for engineer EEI (terrain information).

orders issued to those agencies if the unit is well trained; and in any case would not appear on the collection plan.

f. Relation to Other Engineer Planning. Accurate and timely information is the basis of all sound planning. A collection plan is therefore an integrated part of engineer planning considered as a whole.

34. Issue of Orders and Check on Collecting Agencies

Using the completed collection plan as a basis, the intelligence agency preparing it issues the necessary orders to the collecting agencies or arranges for their issuance through the proper channels. Thereafter it makes any necessary checks to insure that the information is promptly and adequately obtained and reported.

CHAPTER 6

THE PRODUCTION PHASE

35. Processing Information

After engineer information has been collected, it is sorted, grouped, and recorded by subjects in order to facilitate its conversion into intelligence. Next, it is evaluated and interpreted. The phases of processing information into intelligence are discussed in subsequent paragraphs. Intelligence data must be concise and ready for immediate use. It must present the facts and their significance, together with all deductions drawn for their study, in the light of other intelligence already at hand. The process is continuous and in operation at all times.

36. Recording

This phase of the process arranges information in a systematic form to facilitate its processing into intelligence. The intelligence officer on duty examines incoming information at once for items of immediate tactical importance, before any recording is done. He first takes prompt action on any such items, then proceeds to have the information systematically arranged, sorted, grouped, and listed by subjects, so that items of the same kind may be kept together for convenience of comparison, study, and reporting. From the standpoint of combat engineer intelligence, there are five general aids by means of which the mechanics of recording are accomplished. They are the intelligence (or G2) journal, the worksheet, the engineer intelligence situation map, the intelligence file, and the record of target locations.

37. The Intelligence Journal (or G2 Journal)

This is the daybook of the engineer intelligence section. The journal contains briefs of important written and oral messages received and sent, as well as notations of periodic re-

ports, orders, records of important conferences, and similar matters pertaining directly to the engineer intelligence section. It is an official permanent record of an engineer unit and the primary record of operations of the intelligence section of the headquarters. The journal is closed daily or at the end of a phase or period as directed. At the close of each day a summary of important events should be entered as the last item. The summary should include particularly the reasons for the decisions and happenings. These daily summaries are the basic data for incorporation into the command report which is periodically submitted to a designated higher headquarters.

38. The Worksheet

The engineer worksheet is an indexed pad or looseleaf notebook in which information is recorded systematically and arranged by subject for ready reference and comparison. The worksheet is an aid in the evaluation and interpretation of information, and in the preparation of intelligence reports. Although there is no prescribed form for the worksheet, index tabs are customarily labeled to correspond with the headings of the periodic intelligence reports. The unit's intelligence requirements determine the subject headings used on its worksheet. After an item of information has been recorded in the journal, it is posted under the appropriate subject or subjects on the worksheet. As items become obsolete, they are lined out; as pages become obsolete, they are removed. Figure 6 shows a sample engineer intelligence worksheet.

39. Engineer Intelligence Situation Map

a. Description. The engineer intelligence situation map provides a graphic picture of the friendly and enemy situation. It contains in-

(CLASSIFICATION)
ENGINEER
INTELLIGENCE
WORK SHEET

FROM : _____
 TO : _____ HOUR AND DATE
 HQ : _____ HOUR AND DATE
 PLACE : _____

NOTE: Units use headings appropriate to their needs.
 Obsolete pages may be discarded.

SUBJECT HEADINGS

- Airfields
- Bridges
- Camouflage
- Construction
- Fortifications
- Minefields
- Order of Battle
- Pits & Quarries
- Roads
- Supply
- Surveillance
- Terrain
- Traffic

(CLASSIFICATION)

(CLASSIFICATION)			
Journal reference	Date	Source	Information
J-3	120910 <i>Feb</i>	1 st bg	Apers Minefield at CS121651
J-5	120943 <i>Feb</i>	2 ^d bg	Minefield at CS119321
J-7	121535 <i>Feb</i>	ACO	New type nonmetallic mine discovered at CS121654 - Sent to 533 ^d ETID

(CLASSIFICATION)

Figure 6. Engineer intelligence worksheet.

formation on such items as terrain, roads, bridges, barriers, enemy minefields, water supply points, enemy depots and dumps, and construction materials. It supplements the worksheets and serves as a base for preparing overlays.

b. Coverage. The situation map covers both friendly and enemy territory. Friendly information includes a trace of the frontline, boundaries between major units, and the location of headquarters of major units. Tactical informa-

tion includes only that which has a bearing on the engineer mission, including internal security. Standard military symbols given in FM 21-30 and topographic symbols given in FM 21-31 are used. Posting of detailed data on the face of the map is kept to a minimum.

c. Timeliness. The situation map must be kept up to date. It is often needed on short notice for urgent purposes where timeliness is vital, such as briefing the commander or his staff.

40. Engineer Intelligence Files

a. *Journal File.* The journal file contains the originals or copies of all documents entered in the intelligence journal. It supports the journal.

b. *Photographic Negatives File.* A file of photographic negatives is maintained by an engineer intelligence section which has a photographer.

c. *Minefield Files.* Separate files are kept on both friendly and enemy minefields.

41. Target Locations

The intelligence section of the staff engineer keeps up-to-date information on the location, type, and importance of existing and potential targets of interest to engineer agencies. It may be gathered by ground or air reconnaissance, terrain detachments, or through intelligence channels. The information is evaluated and then listed according to map coordinates, overprinted on a map, or placed on a map overlay, with a notation estimating its accuracy.

42. Evaluation of Information

Evaluation is the appraisal of an item of information to determine its pertinence, the credibility of the source or agency, and its accuracy. For full details, see FM 30-5.

a. *Pertinency.* Immediately upon receipt of an item of information it is given to the intelligence section where its relevance, urgency, and value are determined. If the information is not pertinent, it is not processed at that time. Information needed immediately is disseminated in its raw form. Pertinent information which is not needed at once is completely processed before it is disseminated.

b. *Credibility.* The information that is pertinent is evaluated for reliability of the source and of the collecting agency.

- (1) *Source.* The principal basis for determining the reliability of a source is knowledge of or previous experience with that source. Experience may indicate, for example, whether prisoners of war give reliable information, and whether wounded prisoners are less reliable than unwounded. Records may show that enemy deserters are less reliable than prisoners captured in an assault. Plans, orders, and similar documents are usually reli-

able, but sometimes they are planted by the enemy to be found by us. Plans, too, may have been based on false assumptions or enemy orders may have been changed.

- (2) *Agency.* A collection agency is an individual or an organization which obtains information by observation, surveillance, analysis, reconnaissance, and/or interrogation. Collection agencies exploit sources of information. A reconnaissance patrol and photointerpreter are examples of collection agencies which normally obtain information which becomes valuable engineer intelligence. The experience of the collecting agency affects reliability, and so do the circumstances and means of collection. Observations made under exciting circumstances or at night might be less reliable than those calmly made during the day.

c. *Accuracy.* Along with the estimation of the reliability of source and agency, information is judged as to accuracy. Seeking answers to such questions as the following would help determine accuracy.

- (1) Is the fact or event possible?
- (2) Is it consistent?
- (3) Is it confirmed from other sources?
- (4) How does it agree with information known to be true?

Because actual confirmation is the most reliable method of determining accuracy, the intelligence officer seeks to obtain the same information through different agencies and many sources.

d. *Rating.* The rating of each item of information is indicated by means of a standard system. The evaluation of reliability is indicated by a letter; the evaluation of accuracy by a number.

- (1) *Evaluating reliability.* The evaluation of the reliability of source and agency is indicated as follows:

A Completely reliable.
B Usually reliable.
C Fairly reliable.
D Not usually reliable.
E Unreliable.
F Reliability cannot be judged.

(2) *Evaluating accuracy.* The evaluation of the accuracy of an item of information is indicated as follows:

- 1 Confirmed.
- 2 Probably true.
- 3 Possibly true.
- 4 Doubtfully true.
- 5 Improbable.
- 6 Truth cannot be judged.

(3) *Use.* The letter and the figure are independent of each other. A completely reliable source, for example, may report information that is improbable, based on other information. The evaluation of this report would be "A-5". Conversely, an unreliable source may report an item that has been fully confirmed through other sources. This is evaluated as "E-1".

(4) *Recording evaluation.* Every engineer intelligence report must indicate the reliability and accuracy of its content according to the rating criteria given above.

43. Interpretation of Information

After an item of information has been evaluated as reasonably accurate and as pertinent, the next step is to decide its military significance and importance. This is the final step in the conversion of "information" into "intelli-

gence". It involves a judgment—in the light of previously processed intelligence, the enemy's situation, and our own situation—as to what consideration should be given to the new item of information. For example, a report might contain the information needed to confirm our previous estimate of the existence of large stocks of enemy construction material in an area where our forces are planning an attack; or, on the other hand, might cast serious doubt on the previous estimate. As a result, tentative plans already formed for engineer supply during and following the attack might be finally adopted, or alternatively might be radically modified.

44. Current Files

There is always a danger of overloading intelligence files with outdated reports and other data. If data has no bearing on the units present or future activities in the theater of operations, the information is not worth processing and filing, even if the information is reliable and accurate. It must be borne in mind, however, that intelligence and information of this type should be forwarded through intelligence channels instead of being retained in the unit, since an item of information that is valueless at one headquarters may be of value to a higher, lower, or adjacent headquarters.

CHAPTER 7

THE DISSEMINATION PHASE

45. Definition and Objective of Dissemination

a. Dissemination of intelligence, including engineer intelligence, is its transmission from the producer to the users. The object of dissemination is to provide the units and agencies with the information they need when they need it.

b. Material disseminated to any one agency is confined to what that agency can use, unless this involves too much selective paperwork. It is in such form that the using agencies can readily locate what they want to know.

c. Material is disseminated upward, laterally, and downward.

(1) Material disseminated upward is screened to eliminate items which, although of value at and below the level where it was processed, is unimportant at higher levels. In general, the more detailed items are omitted, but there are many exceptions to this rule. Guidance and instructions are received from agencies as to what is desired. If no guidance has been given, the next higher and lateral agencies and units should be queried regarding the matter.

(2) Material disseminated laterally is screened to retain only data of interest to adjacent units or agencies, engineer and other.

(3) All pertinent engineer intelligence produced at any level is disseminated downward to lower echelons, although not all of it necessarily goes to each recipient in a given echelon.

d. The problem of dissemination downward is usually the most complex and involves the most effort. The material is more detailed; the time element is usually more acute; and there

are more recipients, and hence a greater mechanical problem of reproduction and transmission.

e. The engineer intelligence officer at any level must be familiar at all times with the plans, activities, and problems of his own engineer, of his command, and of subordinate engineer commands and agencies. Only thus can he rightly determine the kind, amount, and timing of intelligence which is needed at various engineer levels.

46. Timing

Engineer intelligence must be in the hands of those agencies (troop commanders or staff sections) who need the intelligence in time to permit them to make practical use of it in their planning and operations. Disseminating agencies must allow sufficient time for the physical transmission and clearance of the intelligence through the immediate headquarters before it reaches the ultimate user. This is especially important in the case of dissemination downward. It is also important in a fast-moving situation with respect to dissemination in any direction. In urgent cases, partial or fragmentary reports may be sent. Summaries may be transmitted by wire or radio in advance of a complete report, or incompletely processed intelligence may be disseminated with a precautionary note incorporated into the text of the report.

47. Channels

a. Engineer intelligence is channeled upward through the intelligence officer to the commander and downward through the intelligence officer to the commander of operational units.

b. Operational commands are kept abreast of important enemy engineer technical and scientific trends and developments by reports

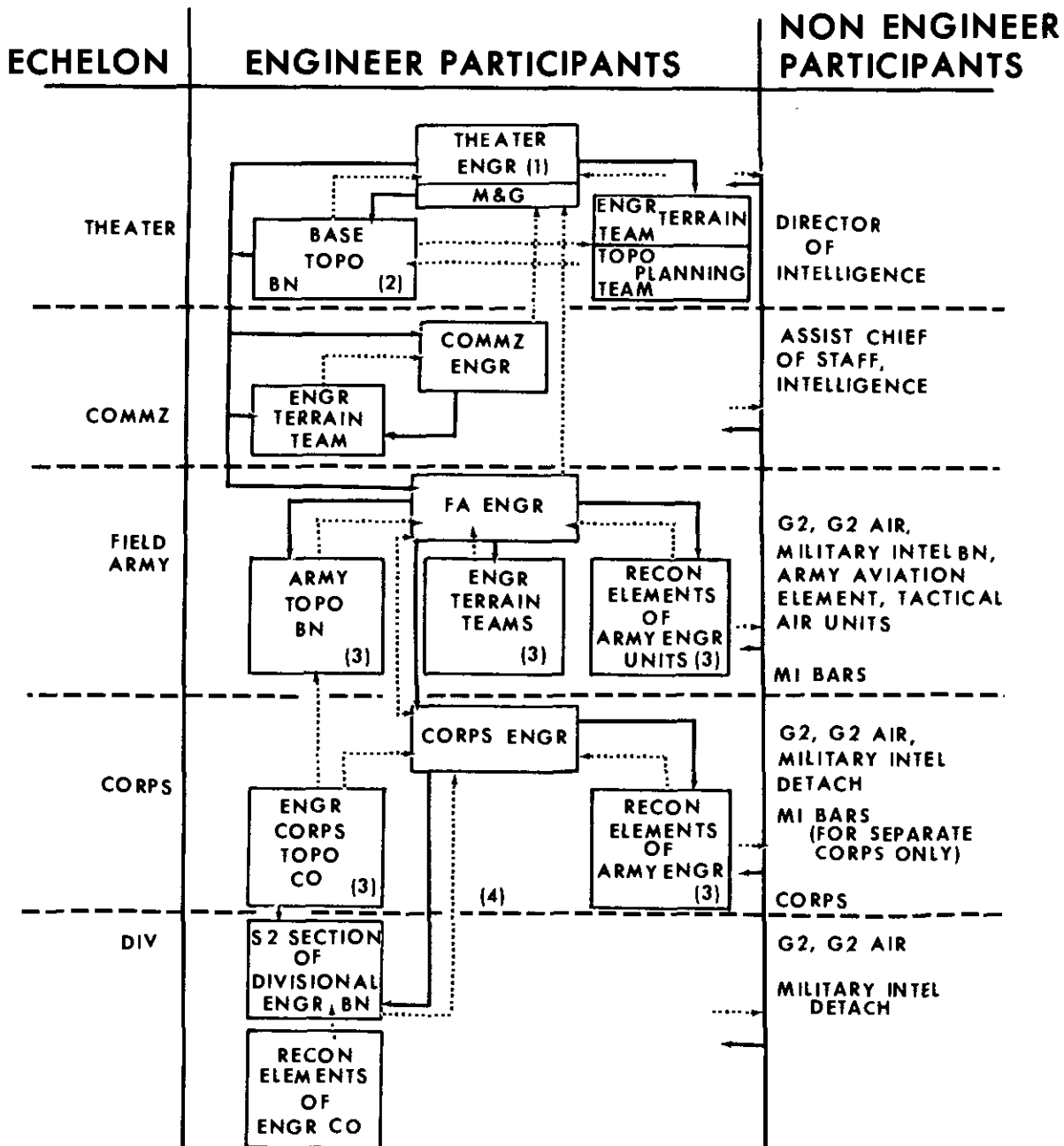

- (1) Engineer staff elements at this level may be contained in the organization of director or assistant chief of staff for intelligence and not exist as a separate engineer staff section.
- (2) May operate under communications zone control.
- (3) May be contained in the engineer brigade.
- (4) A terrain team may be located at corps.

M & G = Mapping and Geography

Figure 7. Flow chart of theater engineer intelligence.

from higher echelons. A continual feedback of information from combat units to higher echelons keeps the cycle alive and productive. Figure 7 is a flow chart of theater engineer intelligence.

48. Means of Dissemination

a. Dissemination within a headquarters usually is made by personal contact, oral reports, briefings, distribution of an intelligence estimate, an analysis of the area of operations, and other written reports which are appropriate for transmitting engineer intelligence.

b. Dissemination to higher, lower, and adjacent units is by means of reports, summaries and studies, intelligence estimates and analyses of the area of operations, operational plans and orders, and maps.

c. Intelligence reports transmitting observed facts should include analysis, integration, and conclusions to the extent practicable. These must be clearly identified and separated.

d. The degree of security classification to be given each report depends on the value the enemy would obtain from the information being disseminated.

e. The following is a list of standard intelligence reports. A detailed discussion of each is given in FM 30-5.

- (1) *Spot report*. A spot report is a one-time report containing information or intelligence for which speed of transmission is of prime importance. A spot report does not follow a prescribed form. It should, as much as possible, answer the questions who, what, when, where, and how.
- (2) *Intelligence report (INTREP)*. This standardized report is used to report information about enemy capabilities.
- (3) *Supplementary intelligence report (SUPINTREP)*. This standardized report is used for more comprehensive reviews and is produced on special request or in preparation for a particular operation.
- (4) *Intelligence summary (INTSUM)*. The INTSUM is a standardized intelligence report which is a brief summary of items of intelligence informa-

tion. It provides a summary of the enemy situation in forward and rear areas, enemy operations and capabilities, and weather and terrain characteristics. It should give a lead to recipients in assessing the situation. It includes negative information but rigidly excludes nonoperational intelligence. It shows the intelligence staff's deductions which, in principle, should be approved by the commander.

- (5) *Periodic intelligence report*. The periodic intelligence report (PERINTREP) is a summary of the intelligence situation covering a longer period than the INTSUM. It is a means of disseminating detailed information and intelligence. It covers the enemy situation and enemy operations, capabilities, vulnerabilities; characteristics of the area of operations; and counterintelligence. It does not contain details of friendly forces which may be of value to the enemy. Other intelligence documents such as technical intelligence summaries, prisoner of war interrogation reports, translations of captured documents, and weather and climate summaries may be disseminated as appendixes to the PERINTREP. The PERINTREP is concise but complete and makes maximum use of sketches, overlays, marked maps, and annexes.
- (6) *Weekly intelligence summary*. This report generally follows the format of a PERINTREP. It serves to highlight trends that are useful in planning future operations and in processing current information. These reports may be issued at field army and higher headquarters.
- (7) *Imagery interpretation reports*. Information or intelligence obtained by imagery interpretation is disseminated by imagery interpretation reports. The basic types of imagery interpretation reports are inflight reports, mission reports (MISREP), hot photo reports (HOTPHOTOREP), immediate photographic interpretation reports (PIR),

and general photographic interpretation reports (GPIR).

- (8) *Nuclear burst and biological or chemical attack reports.* Initial reports and followup data of enemy or unidentified nuclear bursts, or of an enemy biological or chemical attack, are disseminated from the source level through the intermediate headquarters to the highest headquarters practicable by the most expeditious means available. The report format is standardized.
- (9) *Radiological contamination estimates and reports.* Radiological contamination information is disseminated by means of current or future contamination charts. The *current contamination chart* is a plot of dose rate contours of operational interest extracted from the radiation situation map maintained by the chemical, biological, and radiological element (CBRE). In *future contamination charts*, decay factors are applied to estimate the radiation situation at future times. Current and future contamination charts are disseminated to interested staff sections, agencies, and other headquarters.
- (10) *Weather forecasts.* A *weather forecast* is a prediction of the weather conditions expected at a place, or within an area, or along a route at a specified future time, or during a specified period. The accuracy and reliability of weather forecasts depend upon such factors as characteristics of the area, available weather data, reliability of weather communications facilities, forecast period length, and the experience of the forecaster. Reliability of forecasts generally decreases as the forecast period increases. Weather forecasts are in coded (numerical, graphical (pictorial), or written (plain language) format. Weather forecasts for use by troop units are usually in plain language.
- (11) *Current weather reports.* These reports contain information on existing weather conditions or specific weather elements. They may be oral, written, or graphic presentations.
- (12) *Summaries of weather and climate.* These are information summaries used as a basis for other estimates and plans. The summaries are disseminated by intelligence documents such as written analyses of the area of operations, intelligence estimates, and PERINTREPS.
- (13) *Climatic studies.* A climatic study is the analysis and interpretation of climatic information (climatic summary) in the light of probable effects on operations. Climatic studies are disseminated on the same basis as weather and climatic summaries.
- (14) *Technical intelligence bulletins and summaries.* These reports are used to disseminate the results of examination of enemy materiel. Bulletins usually deal with individual items, while summaries are broader in scope. They are disseminated through command channels and technical intelligence channels.
- (15) *Maps.* Maps and related publications are carried as standard stock items in accordance with the procedures prescribed in Army regulations. Information on the dissemination and issue of maps, map substitutes, and other topographic data is given in AR 117-5, FM 5-1, FM 101-10-1, and TM 5-231. Map allowances are issued according to the following categories:
 - (a) *Initial issue.* The primary distribution of maps to a unit for a particular area of operation.
 - (b) *Replenishment issue.* This issue covers losses and copies consumed in the operation, generally a percentage of the initial issue.
 - (c) *Replacement issue.* Substitution of new editions after recall and destruction of obsolete maps. The amount is the same as the initial issue.

CHAPTER 8

STRATEGIC AND TACTICAL PLANNING AND OPERATIONS

49. Functions of Engineer Intelligence

a. Engineer intelligence is an important factor in all categories of intelligence. It is an integral part of the planning for both strategic and tactical operations. Engineer intelligence is used in strategic, tactical, and logistical planning and operations, in determining capabilities and possible courses of action, in political, economic, and psychological warfare, and for training, research, and development purposes.

b. There is an interrelationship between strategic and tactical intelligence. Information gathered and intelligence produced for strategic purposes are often useful in conducting tactical operations. Both are concerned with knowledge of foreign nations and with areas of actual or possible military operations. Both are produced by the application of the same fundamental intelligence collection and processing techniques.

50. Strategic Planning

Strategic planning is worldwide. Most emphasis is given to actual or potential enemies and to friendly nations on whose territory we are or may be fighting with as an ally. Within any nation it is especially concerned with actual or possible areas of operation of our own forces but it is not restricted to those areas. Engineer intelligence needed in such planning includes the following data on a nation as a whole or on any particular area.

a. *Data on Terrain.* This should include major features, such as large rivers, mountain chains, deserts, large swampy areas, coastal areas, jungles, forests, grasslands, and agricultural and urban areas.

b. *Weather and Climatic Data.*

c. *Transportation Data.* This should include the railroad, air, and navigable waterway transportation systems and their carrying ca-

pacities, with available equipment; the road net; and the principal ports. The information on ports should include the major characteristics, normal capacity expressed in number of berths, number of ships loaded and unloaded in a given time, and amounts of general and special cargo passing through the port.

d. *Mineralogical, Agricultural, and Industrial Production Data.* This should include the extent to which the production could be diverted to the needs of our armed forces, or to the provision of such support to the civilian population and refugees as may legally be required. Principal centers of population should also be covered.

51. Logistical Planning and Operations

The categories of engineer intelligence that may be required and to what extent each category will be used for logistical and operational planning depend on the situation and the level at which the planning takes place. In general terms, the engineer intelligence used falls into the following categories:

a. *Natural Geographic Features.* Those features are included which affect logistical activities, including sites for military installations, airfields, ports, and harbors.

b. *Lines of Communications (Logistical Routes).* This category includes roads, railways, ports, navigable waters, and other transportation facilities.

c. *Manmade Facilities.* This includes buildings, utilities, quarries and mining operation facilities, hydraulic structures, and other cultural features.

d. *Resources.* This includes lumber, gas, and minerals.

e. *Data Bearing on Supply.* This includes water supply.

f. Special Engineer Technical Studies. This covers such subjects as enemy construction, equipment, and techniques.

52. Tactical Planning and Operations

Tactical planning and operations have shorter range objectives and require more detail than strategic planning, but the principal subjects to be considered are essentially the same. Much of the tactical planning and operations of engineer units is based on the terrain studies, the content of which depends on the mission, the terrain, the size of the unit, and the commander. In general, engineer support is tailored to the needs of the supported command. Priority of engineer support is given to those tasks which contribute to the mobility of combat units and the movement of essential supplies and equipment. Typical priority missions include engineer reconnaissance, obstacle reduction, combat roads and trails, tactical bridges, forward airfields, ADM support, and assault petroleum, oils, and lubricants (POL) pipeline systems. These are assigned to tactical and logistical units in consonance with the commander's overall plan.

53. Application of Engineer Intelligence

The engineer intelligence officer or staff engineer may be requested to supply the commander with information pertaining to river crossings, obstacles, barriers, air landing sites, or trafficability, or to develop a terrain study of an area for use in the planning and execution of a particular military operation. Some of the information is purely engineer intelligence data; other intelligence is supplemented by nonengineer agencies such as air and ground reconnaissance performed by infantry, armor, or the tactical air force (TAF). For example, in connection with a deliberate tactical river crossing (not airborne) against enemy resistance, the engineer would furnish the following data:

a. Weather to be expected during the operation, with special reference to possible flooding of the river, or the movement of ice or debris,

on a scale that would jeopardize the crossing. Weather intelligence is provided by weather teams at the tactical operations center (TOC).

b. Full information on topography and landforms on both sides of the river, including any natural barriers or obstructions to the advance of our troops other than the river itself.

c. Location and trafficability of roads (FM 30-10) on both sides of the river; location of any actual or potential defiles, including bridges or large culverts that might be destroyed by the enemy.

d. Trafficability of the soil, both now and under any weather conditions that may be expected during the operation. Special attention to be given to areas adjacent to the proposed crossing sites and along the routes of approach thereto.

e. Concealment and cover, especially on the friendly side of the river.

f. Data on enemy defenses on both sides of the river or in the river, including minefields and roadblocks. Statement and details as to whether the enemy can produce artificial flooding of the river.

g. Sites for storm boat or assault boat crossings, footbridges, ferries, vehicular bridges (floating and/or fixed), and dummy bridges if contemplated. (It is often desirable to locate two or more alternative sites for each installation, give advantages and disadvantages of each, and recommend which should be selected.)

h. Avenues of approach to the assembly and parking areas, the crossing sites, and the successive objectives of the attacking force.

i. Sites for engineer dumps, parks, and regulating points.

j. Location, nature, and amounts of engineer construction and other materials located within the area of the operation.

k. Water points for use during the operation.

l. Data on enemy engineer troops within the area and their capabilities.

m. Any special data needed in connection with the possible employment of nuclear weapons.

CHAPTER 9

ENGINEER TOPOGRAPHIC AND INTELLIGENCE UNITS AND CIVIL AFFAIRS

54. Mission

The topographic and engineer intelligence teams, mentioned in chapter 4, provide specialized support to the Army in the theater of operations. These teams normally are attached to a larger unit or organized into an engineer composite unit to provide for engineer topographic and intelligence support under varying conditions.

55. Capabilities

The capabilities of an engineer unit composed of these teams vary with the number and types of teams used. The capabilities of the individual teams are given in this chapter.

56. Logistical Support

Since the teams have no mess or administrative personnel, they must be furnished mess, organizational maintenance, supply, administrative, and personnel services by the supported unit or by the appropriate TOE 29-500 teams.

57. Basis of Allocation

Teams are allocated as required by the engineer topographic or intelligence requirements of the command.

58. Topographic and Intelligence Teams

This paragraph outlines the strength, basis of allocation, strength and mobility of each of the topographic and intelligence teams.

a. Team IA, Survey.

- (1) *Capability.* Provides qualified personnel and equipment to perform second, third, and fourth order topographic and artillery fire control support surveys. Tower and FADAC computer support is provided by the

supported unit.

- (2) *Basic of allocation.* Normally assigned to a corps company or army battalion to provide additional survey support.
- (3) *Strength.* 1 WO 2 NCO 12 EM
15 Agg
- (4) *Mobility.* 100 percent.

b. Team IB, Photomapping Platoon.

- (1) *Capability.* Provides qualified personnel with equipment for the preparation and revision of topographic planimetric and special maps, photomaps, mosaics, and other engineer intelligence data, to include final drafting of map manuscripts, color separation drawings and scribed manuscripts, grids, and marginal data. Requires water supply support from supported unit.
- (2) *Basis of allocation.* May be attached to an engineer topographic battalion, when mapping operations require additional effort. Normally located at army level.

- (3) *Strength.* 1 Off 1 WO 4 NCO
38 EM 44 Agg

- (4) *Mobility.* 80 percent.

c. Team IC, Map Reproduction Platoon.

- (1) *Capability.* Provides qualified personnel and equipment for the production of maps and other engineer intelligence material from original manuscripts.
- (2) *Basis of allocation.* Normally attached to an engineer topographic unit when mapping operations require additional effort.
- (3) *Strength.* 1 Off 1 WO 8 NCO
43 EM 53 Agg

(4) *Mobility*. 80 percent.

d. *Team ID, Map Depot Platoon.*

(1) *Capability*. Provides qualified personnel and equipment for the receipt, storage, and distribution of maps and other engineer intelligence material for a base, army, or corps.

(2) *Basis of allocation*. Normally one to three per topographic battalion to operate forward depots.

(3) *Strength*. 1 Off 3 NCO 34 EM
38 Agg

(4) *Mobility*. 80 percent.

e. *Team IE, Geodetic Survey.*

(1) *Capability*. Provides qualified personnel with equipment to accomplish, instruct in, or supervise first order astronomic observation surveys and computations in a theater of operations survey operation, or in the field army for guided missile and artillery fire control support.

(2) *Basis of allocation*. Normally one per base or army topographic battalion.

(3) *Strength*. 3 Off 1 WO 1 NCO
15 EM 20 Agg

(4) *Mobility*. 100 percent.

f. *Team IF, Terrain.*

(1) *Capability*. Provides qualified personnel with equipment for the collection, evaluation, and dissemination of terrain data, and the production of military terrain studies, and for consultant services in military geology and hydrology.

(2) *Basis of allocation*. Normally one per field army.

(3) *Strength*. 6 Off 1 NCO 6 EM
13 Agg

(4) *Mobility*. 100 percent.

g. *Team IG, Topo Planning.*

(1) *Capability*. Map program and other engineer intelligence planning, and technical supervision of map and engineer intelligence compilation; surveying and geodetic activities, including supervision, collection, maintenance, and dissemination of engineer topographic and artillery fire control survey data; coordination of map and

engineer intelligence reproduction to include evaluation of reproduction facilities, and planning the employment of such facilities; supervision of the topographic map and engineer intelligence program, including the operation of map and engineer intelligence depots and supply points throughout the command. Maintains liaison with higher headquarters and allied armies. Supervises the indigenous reproduction and mapping agency programs used to accomplish the mission.

(2) *Basis of allocation*. One per theater army headquarters, army group headquarters, field army headquarters, or topographic battalion as required.

(3) *Strength*. 8 Off 7 NCO 5 EM
20 Agg

(4) *Mobility*. 100 percent.

h. *Team IH, Photographic Evaluation.*

(1) *Capability*. Provides qualified personnel with equipment to evaluate USAF photographic units' production of photography to determine its suitability for the compilation of military topographic maps.

(2) *Basis of allocation*. Normally to an engineer topographic battalion.

(3) *Strength*. 1 WO 1 NCO 7 EM
9 Agg

(4) *Mobility*. 100 percent.

i. *Team IJ, Survey (Airborne).*

(1) *Capability*. Provides jump-qualified personnel with equipment to perform second, third, and fourth order topographic and artillery fire control support surveys for an airborne corps or independent airborne force to include support of TOE 5-195T, Engineer Combat Battalion (Airborne). Tower and FADAC computer support must be provided by others.

(2) *Basis of allocation*. Normally assigned to a topographic unit.

(3) *Strength*. 1 WO 2 NCO 12 EM
15 Agg

(4) *Mobility*. 100 percent.

j. Team II, Military Hydrology.

- (1) *Capability.* Provides for prediction of river stages and discharges, and of natural and artificial flood velocities, depths, and widths in a drainage basin of small to moderate size, up to 1,000 square miles. The team prepares studies of hydrologic and hydraulic factors involved in military installations from the point of view of flood incidence, and gives technical advice on hydraulic features of logistic operations and on equipment for use in water. Theater or CONUS commanders will provide for the allocation of necessary communications facilities and for joint operation of Air Weather Service Units and Corps of Engineer units when such is considered necessary.
- (2) *Basis of allocation.* Normally one per field army or separate corps. May be assigned to a geographic area determined by stream and drainage basin characteristics.
- (3) *Strength.* 5 Off 1 NCO 16 EM
22 Agg
- (4) *Mobility.* 100 percent.

59. Table of Organization and Equipment

The table of organization and equipment of engineer troop organizations and the modification of units are given in appendix B, C 1, FM 5-1, and TOE 5-540D.

60. Engineer Role in Civil Affairs

The commander and his staff must have accurate, complete, and timely civil affairs (CA) intelligence which determines the necessary requirements for the control and welfare of the people of the area (FM 41-10). This intelligence involves the economic, sociological, psychological, and other necessities and comforts of the inhabitants. The civil affairs officer or the G5 in divisions is responsible for civil affairs. He can, however, depend on the engineers for engineer intelligence in his planning

and for assistance from the engineers as well as from other agencies in carrying out his plans.

a. Area Surveys. In the drafting of a CA intelligence collection plan prior to moving into an area of operations, the engineers supply the following information on the area: topography, hydrology, climate, weather, and terrain. The latter includes land forms, drainage, vegetation, and soils. They also supply the intelligence sources on caves, mines, urban buildings, and other construction, rural buildings, storage of crops, hiding places, and shelters. Area surveys are conducted on the ground through physical reconnaissance and the use of all available local sources of information.

b. Real Estate.

- (1) The acquisition and disposal of real estate is an engineer responsibility and is usually accomplished by engineer real estate officers. These officers and real estate teams can often provide valuable information and intelligence because they are familiar with the area, the facilities, and many local problems. Real estate teams should work closely with civil affairs officers and agencies because of the mutual benefits.
- (2) Civil affairs officers and agencies assist the engineers by determining the availability of real estate for military use and by establishing the limitations that should be imposed on its use and the effect of its use on the local economy.

c. CA Assistance in Obtaining Engineer Intelligence. CA collects maps, blueprints, plans, industrial and commercial records, documents, technical intelligence information, and equipment of interest to engineers. It also aids in supplying labor in the skills and types required by the engineers and describes the general attitude of the civilian population of an area.

CHAPTER 10

ENGINEER INTELLIGENCE TRAINING

61. Responsibility

Success in developing effective engineer intelligence depends largely on the quantity and quality of instruction given engineer personnel. The Commander is responsible for the intelligence training of his unit. The intelligence officer, in coordination with the operations officer, exercises staff supervision of intelligence training within the command. At company level the Commander supervises the training prescribed by directives from higher headquarters and requires maximum participation by all members of his unit. Commanders of detachments or team commanders of units organized under TOE 5-540 (Engineer Topographic and Intelligence Teams) are charged with the same training responsibilities. They receive training guidance and assistance from the organization to which they are attached.

62. Intelligence Training

a. All personnel assigned to engineer units receive intelligence training. The training must be realistic and integrated with other engineer activities whenever possible. The realism may be achieved by integrating the engineer intelligence activities with the regular combat-type training. Personnel are taught how to use the engineer intelligence they already have, and how to obtain additional information to increase the effectiveness of the engineer intelligence effort.

b. Engineer intelligence training may be correlated with most engineer activities, such as various kinds of construction, the clearing of minefields, demolitions, and all types of reconnaissance. Specific intelligence activities suitable for integration with other engineer activities include—

- (1) Making corrections on maps
- (2) Sketching trails or routes

- (3) Photographing areas or objects
- (4) Locating caves and tunnels
- (5) Finding mines and boobytraps
- (6) Using radiological monitoring devices, and
- (7) Noting and recording practices of the natives such as methods of keeping drinking water cool and the selection of edible roots and fruit.

c. Engineer intelligence training must also include the understanding of how to use weather information. The individual must know the effects that weather has on personnel, on weapons and various equipment, on terrain and trafficability, and on tactical operations in order to know what information pertaining to weather is useful.

63. Engineer Intelligence Training During Maneuvers

At this stage the individual should have sufficient knowledge of and interest in engineer intelligence to carry out what he has learned, to stimulate others, and to find satisfaction in obtaining and reporting intelligence information. The unit commander must remain alert to point out the new facets and expedient methods in obtaining information and in using intelligence applicable to specific situations. He must also keep the intelligence effort coordinated, correct errors made by his men, and compliment the individuals and the unit as a whole for intelligence work that merits recognition.

64. Continuation of Training

Engineer intelligence training is not concluded with the training phase. It must be conducted on a continuous basis and perfected systematically during the entire military career of engineer personnel.

APPENDIX A

REFERENCES

1. Army Regulations

AR 117-5 Military Mapping and Surveying.

2. Special Regulations

SR 115-15-5 Hydrological and Meteorological Services.

3. Field Manuals

FM 5-1 Engineer Troop Organizations and Operations.
FM 5-26 Employment of Atomic Demolition Munitions (ADM).
FM 5-36 Route Reconnaissance and Classification.
FM 5-146 Engineer Topographic Units.
FM 21-26 Map Reading.
FM 21-30 Military Symbols.
FM 21-31 Topographic Symbols.
FM 21-75 Combat Training of the Individual Soldier and Patrolling.
FM 30-5 Combat Intelligence.
FM 30-9 Military Intelligence Battalion, Field Army.
FM 30-10 Terrain Intelligence.
FM 30-16 Technical Intelligence.
FM 30-20 Aerial Surveillance.
FM 31-60 River Crossing Operations.
FM 41-10 Civil Affairs Operations.
FM 55-8 Transportation Intelligence.
FM 61-100 The Division.
FM 101-5 Staff Officers' Field Manual—Staff Organization and Procedure.
FM 101-10-1 Staff Officers' Field Manual Organization, Technical and Logistical Data (Unclassified Data).
FM 101-31-1 Staff Officers' Field Manual—Nuclear Weapons Employment.

4. Technical Manuals

TM 5-231 Mapping Functions of the Corps of Engineers.
TM 5-243 Cartographic Aerial Photography.
TM 5-330 Planning, Site Selection and Design of Roads, Airfields and Heliports, in the Theater of Operations.
TM 5-545 Geology.
TM 5-700 Field Water Supply.
TM 30-245 Photographic Interpretation Handbook.
TM 30-246 Tactical Interpretation of Air Photos.

5. Tables of Organization and Equipment (TOE)

TOE 5-35 Engineer Combat Battalion, Army or Corps.

TOE 5-52 Headquarters and Headquarters Company, Engineer Combat Group or Headquarters and Headquarters Company, Airborne Engineer Combat Group.

TOE 5-101 Headquarters and Headquarters Company, Engineer Combat Brigade, Army, Corps or Airborne.

TOE 5-195 Engineer Combat Battalion, Airborne.

TOE 5-201 Headquarters and Headquarters Company, Engineer Command.

TOE 5-305 Engineer Topographic Battalion, Army.

TOE 5-327 Engineer Topographic Company, Corps.

TOE 5-344 Engineer Base Map Depot Company.

TOE 5-346 Headquarters and Headquarters Detachment Engineer Base Topographic Battalion.

TOE 5-347 Engineer Base Reproduction Company.

TOE 5-348 Engineer Base Survey Company.

TOE 5-349 Engineer Base Photomap Company.

TOE 5-500 Engineer Service Organization.

TOE 5-540 Engineer Topographic Teams.

TOE 29-500 Composite Service Organization.

TOE 30-600 Military Intelligence Organizations.
 Team LH, Technical Intelligence (Engineer).
 Team LI, Technical Intelligence (Engineer).
 Team LJ, Technical Intelligence (Engineer).

APPENDIX B
SAMPLE ENGINEER INTELLIGENCE PERIODIC REPORT

(CLASSIFICATION)

319th Engr Bn
CHONJU, KOREA (CS 106344)
121900 Feb 1951

ENGINEER INTELLIGENCE PERIODIC REPORT NO. 106

Period Covered: 111800 to 121800 Feb 1951

Map: KOREA, 1:50,000 6329 I and IV

* * * * *

Par. _____ INTELLIGENCE ACTIVITIES FOR THE PERIOD

a. Road reconnaissance conducted in area. Reconnaissance overlay attached as inclosure _____.

b. Enemy AP minefields encountered at CS 121651 and CS 119321. Standard patterns used.

c. New type nonmetallic AP mine discovered in minefields at CS 121654 on 121535 Feb 1951. Mine transmitted to Lt. Jones of 533d ETID.

d. Roads swept for mines in division zone. Mine clearance overlay attached as inclosure _____.

e. Maps distributed during period:
1:50,000-850
1:250,000-250

Signature

Annexes:
Distribution:
Authentication:

(CLASSIFICATION)

APPENDIX C

SAMPLE ENGINEER INTELLIGENCE ANNEX

(CLASSIFICATION)

Copy No. 1
319th Engr Bn
APO 416 US Army
021200 Feb 1951
Message reference number 7

Annex B (Engineer Intelligence) to OpnO 7
Reference: Map, KOREA, 1:250,000, SEOUL Sheet (NJ 52-9)

1. Purpose

This study covers the possible crossing sites on the HAN RIVER within the division boundaries. The area considered extends along the HAN RIVER from the 40th to 55th vertical grid line.

2. General Description of Area

a. Weather. The weather during the month of February is generally cold and clear. Temperatures are always below freezing at night, but may rise above freezing in the daytime. Precipitation is rare, and cloud cover is rarely over 25 percent. Sufficient moonlight for good visibility can be expected from 15 February to 23 February. (See inclosed sun and moon table.)

b. General Terrain. The terrain limits the choice of crossing sites. Between the 44th and the 48th vertical grid line and from the 52d vertical grid line to the division right boundary, mountains border the river and render it inaccessible to anything but foot troops. Elsewhere, wide river valleys open onto the HAN VALLEY from the south. These valleys are low and flat and generally covered with rice paddies. At this season, they are sufficiently frozen to support tracked vehicles. Three usable roads approach the HAN RIVER from the south. A two-lane all-weather road runs along the north bank of the river and a one-lane dry-weather road runs up the PUKHAN VALLEY. (See overlay for road network.)

c. HAN RIVER. The HAN RIVER fluctuates greatly in flow with the seasons. At this season it is at its low point, varying from 180 to 275 meters (600 to 900 feet) in width within the division sector. Except where it runs between mountains, it has a wide, sandy bed. The trace of the bed is sinuous, with cut banks on the concave sides of the bends varying from 2 to 4½ meters (6 to 15 feet) in height. A thin sheet of ice forms out from the banks nightly, but melts during the day. It should pose no difficulty to a crossing.

(CLASSIFICATION)

(CLASSIFICATION)

3. Description of Crossing Sites

Three possible sites have been selected in the division area. They are discussed below as to tactical desirability, bank conditions, and stream conditions.

a. Crossing Site at CS 4952.

- (1) This site has several tactical advantages. It is on a salient projecting into our lines. Two fair roads approach the site from the south. On the north bank there is direct access to a main road. Cover and concealment are available behind the town of PUNWON-NI.
- (2) The south bank is a cut bank about 4½ meters (15 feet) high. From it, an easily widened path leads down to the river. The north bank is a wide, gently sloping gravel beach. Roads can easily be constructed to join the existing road network.
- (3) The river varies in width here from 180 to 245 meters (600 feet to 800 feet). (See overlay.) Its maximum depth is 3 meters (9 feet). The current averages 1.2 meters (4 feet) per second.

b. Crossing Site at CS 5254.

- (1) This site is generally unfavorable tactically. It is on a salient toward the enemy. It requires a long approach over open terrain from PUNWON-NI.
- (2) The south bank is a wide, gradually sloping sand and gravel beach. Roads can easily be constructed across this area. The north bank is a cut bank about 3 meters (10 feet) high. At present, a narrow road descends from the bank to the river. It could easily be widened.
- (3) The river here averages 180 meters (600 feet) in width, with a current of approximately one meter (3 to 4 feet) per second. By utilizing the island, a cross-water span of only 140 meters (450 feet) is required. However, the currents around the island are from 1.5 to 1.8 meters (5 to 6 feet) per second.
- (4) A tank ford may exist at this site, approximately in line with the island. (See overlay.)

(c) Crossing Site CS 4359.

- (1) The site is generally unfavorable tactically. It is on a salient toward the enemy. It requires an approach of several miles, over open terrain, from covered assembly areas. However, once the crossing is accomplished, our forces will be in open terrain and on a good road network.
- (2) The south bank is very wide and covered with loose sand. It is easily traversed by tracked vehicles, but wheeled vehicles will have difficulty. The north bank is a cut bank from 3 to 4.5 meters (10 to 15 feet) high. There is a narrow beach at water level on which vehicles could land. Considerable engineer work would be required to cut a road to the top of the bank.
- (3) At present, water flows only to the north of the island. (See overlay.) The river here is approximately 150 meters (500

(CLASSIFICATION)

(CLASSIFICATION)

feet) wide, with a current of approximately one meter (3 to 4 feet) per second, and is unfordable.

4. Additional Factors

a. A rain or sudden thaw would greatly increase the width, depth, and velocity of the river. While not likely during February, it is possible. Thawing can be expected in March.

b. A dam on the PUKHAN RIVER at CS 6276 controls a reservoir which is nearly full. If this dam were blown, or its gates suddenly opened, it would greatly increase the flow in the HAN RIVER below its junction with the PUKHAN.

c. Both the road and railroad bridges across the PUKHAN RIVER have been destroyed. (See overlay.)

DILLARD
Lt Col

Appendixes: 1—Sun and moon table
2—Overlay

Distribution: A

OFFICIAL:

/s/ Ross
ROSS
S2

(CLASSIFICATION)

APPENDIX D

SAMPLE INTELLIGENCE REPORT ON ENEMY MATERIEL

(CLASSIFICATION)

587th ENGINEER DETACHMENT (TECHNICAL INTELLIGENCE
(COLLECTION)).

APO 23

18 June 1953

Report No. 10

SUBJECT: Chinese Antipersonnel Concrete Ball Mine

TO: The Engineer

IX Corps

APO 50

ATTN: 555th ED (TI) (R)

1. Introduction

a. Three Chinese antipersonnel concrete ball mines (*Transliteration: San-ho-tu chin-chuang ti-lei*) (incl. 1), were found in a ditch near *Koa-San* (CD5678, Korean Map Series 0-235, Sheet No. KL), on 12 June 1953, by members of Company B, 133d Engineer Combat Battalion, and were turned over to this organization (13 June 1953) by the S2 (Lt. John R. Smith) of that Engineer battalion. He stated that the mines were discovered and evacuated while the members of Company B were on a routine reconnaissance. The mines had been lying in the ditch without any special employment, as if the enemy had merely thrown them there.

b. The members of Company B were not contacted for questioning, since the S2 officer was present in the ditch when the mines were removed. The information of the S2 is evaluated as B2.

c. The Chinese nomenclature given above was taken from a report on a POW interrogation submitted by this organization as Report No. 6, dated 20 May 1953.

2. Research

No specialized research was required in the preparation of this report.

3. Description

a. The concrete ball mine (incl. 1) is 25 centimeters (10 inches) in diameter and weighs approximately 9 kilograms (20 pounds); including the fuse assembly, the main charge (two 400-gram blocks of TNT), and the concrete case. The unpainted, spherical case consists of cement, sand, gravel, and fragments of metal.

(CLASSIFICATION)

(CLASSIFICATION)

b. The fuse assembly (incl. 2) consists of a Chinese fuse lighter model 29, 9 centimeters (2 inches) of Chinese P. K. time fuse, an adapter (unidentified) for connecting the fuse to the lighter, a detonator holder (unidentified) and a Soviet MX No. 8 detonator. These items are similar to those of which a description and sketch were given in Report No. 4, submitted by this organization 19 April 1953. The fuse requires 10 seconds to burn through. The fuse assembly is fixed and positioned in the center of the mine by wooden blocks (inclosure 3) and wedges.

c. The main charge, shown in the cross-sectional view, inclosure 2, consists of two standard 400-gram blocks of Soviet TNT, as described and shown on page 250, TM 5-2232.

d. After the main charge has been placed in the mine, as shown in incl. 1, the fuse assembly is inserted by screwing the detonator holder into the threaded detonator well of one of the 400-gram explosive blocks. Two wooden blocks (incl. 3) are placed around the fuse assembly and forced down into the 5 by 7.6 centimeters (2- by 3-inch) hole in the top of the mine. Two small wooden wedges are forced down between the large sectional blocks and the fuse lighter. A trip wire, or a wire controlled by the enemy, may be attached to the pull ring to actuate the fuse lighter. After a 10-second delay, caused by the burning of the time fuse, the detonator explodes the 800 grams of TNT, showering fragments of concrete, stone, and metal in all directions.

e. An investigation of the three fuse assemblies of the mines revealed that in each case weather had affected the time fuse. Water had collected in the hole of the concrete case, wetting the time fuse, which would not burn, until it had been dried. However, the water apparently had no effect on the fuse lighter and main charge.

4. Field Tests

Because only three Chinese ball mines were found, no field tests were made to determine the possible danger radius of this type of mine.

5. Use

a. Methods of employing the Chinese antipersonnel concrete ball mine are not known; but it is apparent that detonation will be accomplished either by a trip wire or by enemy personnel using a pull wire.

b. The 9th Chinese Infantry Division was the enemy organization which had occupied the area before the mines were captured. Since the 8th Chinese Engineer Battalion is the organic engineer unit of that division, it is presumed that the 8th Engineers used the mines. No other mines of this type have been encountered by this intelligence collection unit.

6. Countermeasures

To neutralize this mine the following steps are recommended:

- a. Check both ends of the trip wire for boobytraps, and check the control wire for possible enemy personnel.
- b. Cut trip wire.
- c. Remove wedges.

(CLASSIFICATION)

(CLASSIFICATION)

- d. Lift out wooden blocks.
- e. Lift out fuse assembly and attached explosive.
- f. Unscrew detonator holder from explosive block.
- g. Remove detonator from holder.

7. Production

- a. There were no markings to identify the manufacturer.
- b. It was obvious from visual inspection that the cases of the three concrete mines were formed in the same wooden mold. Markings left by the mold show impressions of a wood-gouging tool which were identical on the surfaces of all three mines.

8. Conclusions

It is the opinion of the undersigned that—

- a. The Chinese ball mine was designed to be employed as a controlled antipersonnel mine.
- b. When so employed, and actuated by a trip wire or pull wire, the mine would be relatively ineffectual against troops, as there would be a 10-second delay after it was actuated. A person hearing the "pop-and-fizzing" noise made by the fuse lighter and time fuse being actuated would have time enough to drop to the ground or to seek cover, thus minimizing the effect of the mine. If and when an instantaneous type of fuse assembly is employed, the mine will be much more effective.
- c. The present mine warfare training program teaches procedures for safely neutralizing the mine.
- d. Since the U. S. Army does not have any mine similar to the one reported on herein, no field comparison can be made of similar types.

9. Disposition

The Chinese ball mines and their complete contents, including the fuse lighter, detonators, and explosive blocks, have been crated and are being forwarded (19 June 1953), via III Corps liaison plane, to the 332 ED (TI) (R) at *Tai-Saeng*; ETA IX Corps Airfield at 1600 hrs 19 June 1953.

3 Inclosures: (Omitted)

Alan G. Aubrey
/s/ ALAN G. AUBREY
1st Lt CE
COMMANDING

(CLASSIFICATION)

INDEX

	Paragraph	Page		Paragraph	Page
Accuracy of information	42d(2)	34	Periodic report	App B	47
Aerial imagery	25e	24	Procedures	5	4
Aerial reconnaissance	24	23	Specialists	20	13
Air Force agencies	13a(2)	9	Engineer worksheet	38	31
Air Force photos	25a(3)	24	Engineers in civil affairs work	60	43
Allied forces	13a(3)	9	Essential Elements of		
Annex, Engineer intelligence	App C	48	Information	31, 32	27
Area search	24b(1)	23	Estimate of radiological		
Area surveys	60a	43	contamination	48e(9)	38
Army Engineer Section	14a	9	Estimate, work	23f(2)	18
Army Map Service	8	7	Evaluating:		
Biological warfare	5i	5	Accuracy	42d(2)	34
Camouflage detection photography	25e(8)	25	Information	42	33
Categories of Engineer			Reliability	42d(1)	33
intelligence	5c	4	Field army	9	7
Checklist, reconnaissance	25e	24	Files:		
Chemical warfare	5i	5	Currency of	44	34
Civil affairs, Engineers in	60	43	Journal	40a	33
Classifications, security	48d	37	Minefield	40c	33
Climatic studies	48e(13)	38	Photo negative	40b	33
Collection effort	30	27	General photographic reports	48e(7)	37
Collection plan	33	28	Geodesy, Intelligence, and		
Color photography	25e(7)	25	Mapping Research and		
Command, Engineer	13b	9	Development Agency	8	7
Coordination	6b, 13a	6, 9	Geodetic survey team	58e	42
CONUS-based commands	9	7	GPIR	48e(7)	37
Defense Intelligence Agency	8	7	Hot photo reports	48e(7)	37
Dissemination of information	45, 48	35, 37	Hydrology team	58j	43
Division	16	10	IA team (survey)	58a	41
Documents	27	26	IB team (photomapping)	58b	41
Enemy documents	27	26	IC team (map reproduction)	58c	41
Enemy materiel	28	26	ID team (map distribution)	58d	42
Enemy materiel, report on	App D	51	IE team (geodetic survey)	58e	42
Engineer brigade	14, 15	9, 10	IF team (terrain)	58f	42
Engineer combat battalion	16	10	IG team (TOPO planning)	58g	42
Engineer command	13b	9	IH team (photographic)	58h	42
Engineer EEI	32, 33b	27, 28	IJ team (airborne survey)	58i	42
Engineer Group	18b	12	IL team (hydrology)	58j	43
Engineer information	4	4	Imagery interpretation	22, 25d(1)	13, 24
Engineer intelligence:			Imagery interpretation reports	48e(7)	37
And other intelligence	6	5	Immediate photo interpretation		
Annex	App C	48	reports	48e(7)	37
Areas of operation	5f	5	Information:		
Categories	5c	4	Accuracy	42c, 42d(3)	33, 34
Channels	47	35	Agencies	42b	33
Division	13c, 16b	9, 10	Collecting	19	13
Functions	49a	39	Credibility	42b	33
Mapping brigade	14b	10			

	Paragraph	Page		Paragraph	Page
Dissemination	45	35	Photography	22, 23f(2)	13, 23
Evaluation	42	33		(b), 25e	24
Interpretation of	43	34	Photomapping team	58b	41
Pertinency	42a	33	Photomaps	25e(4)	25
			Pictomaps	24e(5)	25
Processing	35	31	PIR	48e(7)	37
Rating	42d	33	Planning:		
Recording	36	31	Logistical	51	39
Reliability	42d(1)	33	Reconnaissance	23e	14
Report	29	27	Strategic	50	39
Scope	4	4	Tactical	52	40
Sources	16d, 42b(1)	10, 33	Principles of reconnaissance	23b	14
Timeliness	46	35	Processing information	35	31
Infrared photographs	25e(9)	25	Radar images	25e(8)	25
Intelligence:			Radiological contamination		
Data	5h	5	estimate	48e(9)	38
Engineer	5	4	Reconnaissance:		
Engineer channels for	47	35	Aerial	24	23
Files	40	33	Army aircraft	24c	23
From combat troops	21	13	Bridge	23f(2)	18
Journal	37	31	Checklist	23e	14
Officer	7	6	Recording	23f(2)	18
Periodic report, example of	App B	47	Report	23f(2)	18
Situation map	39	31	Route	24b(3)	23
Staff engineer for	7	6	Visual	24d	24
Strategic	49b	39	Reliability of information	42d(1)	33
Summary	48e(4)	37	Reports:		
Tactical	49b	39	Enemy materiel	App D	51
Targets	41	33	Imagery interpretation	48e(7)	37
Teams	54	41	Intelligence	48e(2),	37, 47
Training	61-64	44		App B	
Interpreter, imagery	22	13	Nuclear	48e(8)	38
Interrogation	26	26	Periodic intelligence	48e(5)	37
INTREP	48e(2)	37	Radiological contamination	48e(9)	38
INTSUM	48e(4)	37	Spot	48e(1)	37
J-staff structure	13	9	Supplementary intelligence	48e(3)	37
Journal, intelligence	37	31	Technical intelligence	48e(14)	37
Journal file	40a	33	Weekly summary	48e(6)	37
Logistical planning	51	39	Security classification	48d	37
Map distribution team	58d	42	Side-looking airborne radar	25e	24
Map issue	48e(15)	38	Situation map, intelligence	39	31
Map reproduction team	58c	41	SLAR	25e	24
Maps:			Sonne camera	25e(2)	25
Intelligence	10d(4)	8	Sources of Engineer information	16d	10
Photo	25e(4)	25	Specific search	24b(2)	23
Picto	25e(5)	25	Spot report	48e(1)	37
Weather	10d	8	Staff Engineer and the		
Materiel, enemy	28	26	Intelligence Officer	7	6
Minefield files	40c	33	Strategic planning	50	39
MISREP	48e(7)	37	Summary, intelligence	48e(4), 48e(6)	37
Mosaics	25e(3)	25	SUPINTREP	48e(3)	37
Navy agencies	13a(2)	9	Supplementary Intelligence		
Nuclear warfare	5i	5	Report	48e(3)	37
Panoramic photography	25e(6)	25	Survey teams	58a, 58i	41
PERINTREP	48e(5)	37	Tactical planning	52	42
Photo mission reports	48e(7)	37	Targets, intelligence	41	33
Photographic Evaluation Team	58h	42	Teams, intelligence:		
Photographic negative file	40b	33	Allocation	58	41
			Capabilities	55	41

	Paragraph	Page		Paragraph	Page
Geodetic Survey -----	58e	42	Theater of Operations -----	12-18	9
Logistical support for -----	56	41	Topographic and intelligence		
Map distribution -----	58d	42	units -----	17	10
Map reproduction -----	58c	41	Topographic planning team -----	58b	41
Military hydrology -----	58j	43	Training, intelligence -----	61-64	44
Mission -----	54	41	Transportation data -----	50c	39
Photographic evaluation -----	58h	42	Units, topographic -----	17	10
Photomapping -----	58b	41	Visual reconnaissance -----	24	23
Survey -----	58a	41	Weather forecasts -----	48e(10)(11)	38
Survey (airborne) -----	58i	42	Weather maps -----	10d	8
Technical intelligence bulletins ---	48e(14)	38	Work estimates -----	23f(2)	18
Technical intelligence			Worksheet, Engineer -----	38	8
summaries -----	48e(14)	38	Zone of Interior -----	8	7
Terrain team -----	58f	42			
Theater Army Engineer -----	13	9			

By Order of the Secretary of the Army:

HAROLD K. JOHNSON,
General, United States Army,
Chief of Staff.

Official:

KENNETH G. WICKHAM,
Major General, United States Army,
The Adjutant General.

Distribution:

To be distributed in accordance with DA Form 12-11 requirements for Engineer Intelligence.