

DEPARTMENT OF THE  
ARMY FIELD MANUAL

DEPARTMENT OF THE  
AIR FORCE MANUAL

FM 21-10

AFM 160-46

---

# MILITARY SANITATION

DELAWARE NATIONAL GUARD ACADEMY  
STATE ARMORY  
WILMINGTON, DELAWARE

---

DEPARTMENTS OF THE ARMY AND THE AIR FORCE  
MAY 1957

|                  |   |  |
|------------------|---|--|
| FIELD MANUAL     | } | DEPARTMENTS OF THE ARMY<br>AND THE AIR FORCE |
| No. 21-10        |   |  |
| AIR FORCE MANUAL |   |  |
| No. 160-46       |   | WASHINGTON 25, D. C., 6 May 1957             |

## **MILITARY SANITATION**

|   | Paragraph | Page |
|---|-----------|------|
| CHAPTER 1. INTRODUCTION                     |           |      |
| Section I. General.....                     | 1-3       | 4    |
| II. Responsibility for Military Sanitation. | 4-8       | 5    |
| CHAPTER 2. CONTROL OF COMMUNICABLE DISEASES |           |      |
| Section I. General.....                     | 9-22      | 9    |
| II. Diseases of Military Importance.        | 23-40     | 19   |
| CHAPTER 3. FIELD WATER SUPPLY               |           |      |
| Section I. General.....                     | 41-47     | 34   |
| II. Water Reconnaissance.....               | 48-52     | 42   |
| III. Field Water Purification.....          | 53-59     | 45   |
| CHAPTER 4. IMPROVISED SANITARY DEVICES      |           |      |
| Section I. General.....                     | 60, 61    | 57   |
| II. Water Heaters.....                      | 62-66     | 57   |
| III. Mess Gear Washing Devices.....         | 67-69     | 65   |
| IV. Handwashing devices.....                | 70, 71    | 67   |
| V. Shower Facilities.....                   | 72, 73    | 69   |
| CHAPTER 5. WASTE DISPOSAL                   |           |      |
| Section I. General.....                     | 74-76     | 72   |
| II. Human Wastes.....                       | 77-85     | 73   |
| III. Liquid Wastes.....                     | 86-88     | 87   |
| IV. Garbage.....                            | 89-93     | 93   |
| V. Rubbish.....                             | 94-96     | 97   |

\* This manual supersedes FM 21-10, 5 July 1945, including C 1, 27 November 1945, and C 2, 15 January 1946.

|  |   |              |
|--|---|--------------|
| <b>CHAPTER 6. KITCHEN AND MESS SANITATION</b>  |   |              |
| Section I.   | General.....  | 97, 98 99    |
| II.  | Food Inspection.....  | 99-105 100   |
| III.   | Handling and Storage of Food.....   | 106-111 104  |
| IV.  | Preparation and Serving of Food.....  | 112-118 109  |
| V.   | Cleaning of Messes, Kitchen<br>Equipment, and Eating and<br>Cooking Utensils. | 119-123 116  |
| <b>CHAPTER 7. PERSONAL HYGIENE</b>   |   |              |
| Section I.   | General.....  | 124-128 121  |
| II.  | Measures to Protect and Im-<br>prove Health.                                  | 129-141 123  |
| <b>CHAPTER 8. MOSQUITO-BORNE DISEASES AND THEIR CONTROL</b>                          |   |              |
| Section I.   | General.....  | 142, 143 138 |
| II.  | Characteristics of Mosquitoes.....  | 144-146 141  |
| III.   | Control Measures.....   | 147-156 144  |
| IV.  | Insect Resistance.....  | 157-159 165  |
| <b>CHAPTER 9. LOUSE-BORNE DISEASES AND THEIR CONTROL</b>                             |   |              |
| Section I.   | Introduction.....   | 160, 161 168 |
| II.  | Characteristics of Lice.....  | 162-167 170  |
| III.   | Delousing Methods.....  | 168-178 172  |
| <b>CHAPTER 10. FLY-BORNE DISEASES AND THEIR CONTROL</b>                              |   |              |
| Section I.   | Introduction.....   | 179-181 184  |
| II.  | Characteristics of Flies.....   | 182, 183 184 |
| III.   | Control Measures.....   | 184-190 187  |
| <b>CHAPTER 11. ARACHNID-BORNE (TICKS, MITES, SPIDERS) DISEASES AND THEIR CONTROL</b> |   |              |
| Section I.   | Introduction.....   | 191, 192 192 |

|   | Paragraph | Page |
|---|-----------|------|
| II. Characteristics and Habits of Ticks.                                      | 193       | 194  |
| III. Control of Ticks.....  | 194-199   | 196  |
| IV. Mites and Chiggers.....   | 200, 201  | 198  |
| V. Black Widow Spider.....  | 202       | 203  |
| VI. Scorpions.....  | 203, 204  | 205  |
| CHAPTER 12. FLEA-BORNE DISEASES AND THEIR CONTROL                             |           |      |
| Section I. Introduction.....  | 205       | 208  |
| II. Characteristics and Habits of Fleas.                                      | 206       | 210  |
| III. Control Measures.....  | 207, 208  | 211  |
| CHAPTER 13. MISCELLANEOUS INSECTS AND INSECT-BORNE DISEASES AND THEIR CONTROL | 209-217   | 214  |
| 14. RODENT-BORNE DISEASES AND THEIR CONTROL                                   |           |      |
| Section I. Introduction.....  | 218-223   | 230  |
| II. Rodent Control.....   | 224-233   | 235  |
| CHAPTER 15. MISCELLANEOUS DISEASES  | 234-239   | 246  |
| 16. ADAPTATION AND THE PROBLEMS OF EXTREME CLIMATE                            |           |      |
| Section I. General.....   | 240, 241  | 254  |
| II. Life in the Tropics.....  | 242-247   | 255  |
| III. Life in the Arctic.....  | 248-256   | 264  |
| CHAPTER 17. MARCH HYGIENE AND CAMP SITES                                      |           |      |
| Section I. March Hygiene.....   | 257-261   | 274  |
| II. Selection of Camp Sites.....  | 262-268   | 279  |
| APPENDIX CONVERSION TABLES.....   |           | 286  |
| INDEX.....  |           | 290  |

# CHAPTER 1

## INTRODUCTION

---

### Section I. GENERAL

#### 1. Purpose and Scope

This manual provides information and instruction in the use of established, practical measures designed to preserve health and prevent disease in the Army. It explains the fundamentals and principles of sanitation and their application under garrison and field conditions. It points out the responsibilities of command and of the individual soldier for knowing and observing the rules of sanitation and hygiene, especially as they apply to living conditions and circumstances peculiar to the military service.

#### 2. Definition

*a.* Sanitation may be defined as the effective use of measures which will create and maintain healthful environmental conditions. Among these measures are the safeguarding of food and water and the control of disease-bearing insects and rodents.

*b.* Hygiene may be defined as the employment, by the individual, of practices which will keep him healthy. Among these practices are proper eating, body cleanliness, and the avoidance of known sources of disease.

*c.* Military sanitation includes the practices of

both environmental sanitation and personal hygiene, particularly within the framework of situations and experiences associated with Army life.

### **3. Importance of Military Sanitation**

Manpower is our most valuable asset. Everything possible must be done to conserve this asset. In recent wars more deaths have resulted from enemy action than from disease, but disease still causes the greatest loss of Army manpower through disability and time lost from duty. Success in battle—the ultimate objective of any army—demands that troops be maintained in a constant state of combat readiness. Military sanitation contributes to this effort by employing all of the measures designed to protect and improve the health of the Army.

## **Section II. RESPONSIBILITY FOR MILITARY SANITATION**

### **4. Command**

*a.* The commanding officer of a military organization is responsible for the health of his command. In the fulfillment of this responsibility he is assisted by a staff of trained specialists. With the help of their technical advice and guidance, the commander issues orders and enforces measures which will most effectively maintain military sanitation and practices conducive to the health and well-being of his troops. The maintenance of the health and, consequently, the fighting efficiency of his command is one of the commander's highest responsibilities.

b. Supporting the commander in the performance of this duty is his chief medical adviser—the surgeon of the command. The surgeon is responsible to the commander for the successful functioning of the medical service within his command, including treatment of disease and injury; devising, recommending, and supervising training and activities directed toward disease prevention, personal hygiene, and first aid; furnishing technical advice and supervision in connection with the health aspects of camp sites, water supplies, food and its preparation, waste disposal, bathing facilities, housing, clothing, and insect and rodent control. While it is the commander's direct responsibility to *enforce* the practices of military sanitation, it is the surgeon's responsibility to advise *what* should be done. Only in matters involving technical and professional knowledge does the surgeon specify *how* it should be done. The commander may authorize the surgeon to give orders in his (the commander's) name for effecting immediate correction of sanitary defects. Even then, full responsibility remains with the commander.

## 5. Army Medical Service

The Army Medical Service has the mission of providing a complete health service for the Army. Personnel of the Army Medical Service, under the surgeon, who are particularly concerned with disease prevention and military sanitation measures are the preventive medicine officer, the veterinary officer, the sanitary engineer, the entomologist, the nutrition officer, and members of preventive medi-

cine units. Any or all of these specialists and others may be assigned to and utilized in certain larger commands, so far as the size of the command and related circumstances may dictate. When so assigned—

*a.* The preventive medicine officer, under the surgeon, recommends and supervises an adequate program of preventive medicine for the command to which he is assigned. This program encompasses personal hygiene, communicable disease control, environmental sanitation, and nutrition.

*b.* The sanitary engineer and the entomologist serve as assistants and technical advisers to the preventive medicine officer and the surgeon regarding problems of sanitary engineering and the control of disease-bearing insects and rodents.

*c.* The nutrition officer and the laboratory officer serve as assistants and technical advisers to the surgeon on matters of diet, examination of water, milk, and food, and specimens from the sick.

*d.* The veterinary officer serves as an assistant and technical adviser to the surgeon and is responsible for the inspection of animals, foods of animal origin, and certain other foods, as directed.

*e.* Preventive medicine units—comprising entomologists, sanitary engineers, laboratory specialists, and enlisted men trained in sanitation and insect and rodent control—supervise and assist in the execution of measures of disease control within the command as recommended by the surgeon.

## **6. Corps of Engineers**

The Corps of Engineers is responsible for the design, construction, and operation of many facili-



ties and services necessary for the maintenance of health. It plans, constructs, and maintains buildings, grounds, water treatment plants and sewage disposal works. Services such as heat and light and, sometimes, insect and rodent control, are also furnished by the Corps of Engineers.

## **7. Quartermaster Corps**

The Quartermaster Corps is responsible for the provision of food and of mess equipment for the Army. It furnishes trained personnel for the operation of Army bakeries, laundries, and mobile shower units. It provides and repairs Army clothing, footwear, and tentage. Practically all of the supplies and materials required for personal hygiene, insect and rodent control, and the sanitation of barracks and messes are furnished by the Quartermaster Corps.

## **8. The Individual**

The preservation of the health of the Army is the responsibility of every individual member of the Army. Even one soldier's ignorance of or indifference to the practices of military sanitation can counteract much of the combined effort of the many services working for his welfare. For his own sake, as well as for the sake of his comrades, it is imperative that every soldier know and observe the rules of hygiene and sanitation and adhere to the principles of good health and good living.

# CHAPTER 2

## CONTROL OF COMMUNICABLE DISEASES

---

### Section I. GENERAL

#### 9. Definition

Communicable diseases are those illnesses which can be transmitted from man to man or from animal to man. The term "communicable" includes "contagious," "infectious," or "catching" diseases which result from close or direct contact with infected persons, from exposure to the breath, cough, or discharge of such persons, or from the bites of animals. Communicable diseases may also be transmitted by food, water, milk, air, and insects.

#### 10. Types of Organisms which Cause Disease

Communicable diseases are caused by the growth within the body of certain "germs"—"organisms" or "infectious agents." These germs enter the body, multiply, and cause illness. Most of them are so small that they can be seen only with a microscope. They are able to survive for varying periods of time in the substances of our environment, such as air, water, earth, animal matter, and vegetable matter. These disease agents are divided into a number of different groups called, respectively, viruses, Rickettsia, Protozoa, bacteria, yeasts, molds, and worms.

#### 11. Groups of Communicable Diseases

Communicable diseases may be classified into

five groups, known as the respiratory, intestinal, insect-borne, venereal, and miscellaneous groups. They differ from one another in the manner in which they are spread and in the type of control needed to prevent their spread.

a. *Respiratory Diseases.* These are diseases which are usually transmitted from person to person by discharges (spray, cough, sneeze, breath) from the nose, mouth, throat, or lungs of an infected individual. Examples: common cold, pneumonia, septic sore throat, and tuberculosis.

b. *Intestinal Diseases.* These are diseases which are usually transmitted by food or water that has become contaminated with feces or urine from an infected human or animal. Examples: typhoid and paratyphoid fevers, dysentery, cholera.

c. *Insect-Borne Diseases.* These are diseases which are transmitted from person to person by insects. Examples: malaria, typhus, yellow fever.

d. *Venereal Diseases.* These diseases are transmitted from person to person by sexual intercourse. Examples: syphilis, gonorrhoea, and chancroid.

e. *Miscellaneous Diseases.* This group includes those communicable diseases which do not fall into any of the above groups. Examples: tetanus (lockjaw), scabies (the "itch"), rabies (hydrophobia), and dermatophytosis (athlete's foot).

## 12. Essentials for the Transmission of Disease

Each case of communicable disease potentially represents steps in a series of events which may

lead to a new case of disease. Each step in this series is dependent on the successful completion of the preceding step to form a link in the chain of the spread of infection. The three links in this chain are (1) the source (reservoir), (2) the means of transmission (vehicle), and (3) the susceptible individual (fig. 1). If any of the links in this chain can be broken, disease will not result (fig. 2).

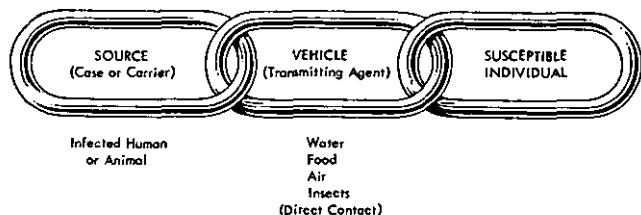

Figure 1. The chain of infection.

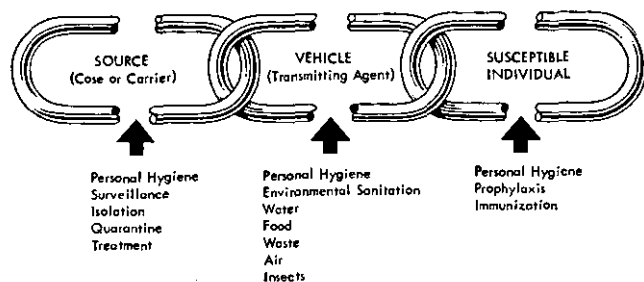

Figure 2. Break the chain of infection.

### 13. Source of Infection (Reservoir)

The source of infection may be a case, a carrier, or an animal.

*a. Case.* A person who is actually ill with a disease is called a case. A case is a common source of infection.

b. *Carrier*. A person who harbors disease organisms, but who is not ill, is called a carrier. This person can spread the germs in the same manner as does the case, and is actually more dangerous because he may not know that he is harboring the infectious agent.

#### 14. Methods of Transmission (Vehicles)

Diseases may be transmitted either by direct or indirect methods.

a. *Direct Transmission*. This is a method of transmission in which the infectious organisms pass directly from one person to another. It may happen in either of the following ways:

(1) *Physical contact*. Certain diseases are spread by physical contact with an infected individual. Examples: syphilis, gonorrhoea, scabies.

(2) *Droplet infection*. This type of infection occurs when persons are so close together that droplets which are spread in coughing, sneezing, or even talking are picked up by others. Respiratory diseases are spread in this manner.

b. *Indirect Transmission*. This is the transfer of infection without close contact between the source and the susceptible person.

(1) *Insects*. Flies, fleas, mosquitoes, ticks, mites, and lice are among the insects which spread disease from man to man or from animal to man. They pick up the disease germs by coming in contact with filth (flies); or by biting an infected person (mosquitoes, lice). The infected in-

sects may then transfer these germs to food; or they may deposit them on a human body; or they may inject them into a human body by another bite.

- (2) *Water and food.* Most of the diseases which are transmitted by water and food result from the water or food having become contaminated by feces, urine, or other infectious material from a case or carrier. If water or food is so contaminated and is then not properly treated, these germs may infect the consumer. Outbreaks of disease will occur where the practices of personal hygiene and the sanitary principles of food handling, water purification, waste disposal, and the control of flies and other vermin are not properly observed and enforced. Among the intestinal diseases usually transmitted by contaminated food or water are typhoid fever, dysentery, and food poisoning.
- (3) *Air.* Some of the organisms that are expelled from the respiratory tract of an infected individual are extremely small and light in weight and may remain suspended in the air for hours or may be re-suspended in the dust. Inhalation of these organisms by a susceptible individual can cause disease. Many of the respiratory diseases are transmitted in this manner.
- (4) *Fomites.* This term includes objects

which may become contaminated with disease germs from an infected individual. Clothing, bed linen and eating utensils are examples.

## 15. Susceptible Individual

A "susceptible" or "nonimmune" is a person who has little resistance against a particular organism and who, if exposed to this organism, is liable to contract disease. By contrast, an "immune" is a person who has a high degree of resistance to the organism and who, when exposed, does not develop the disease.

## 16. Immunity

Immunity may be defined as the ability of an individual to resist, or overcome, the invasion of disease germs. Most persons are born with a high level of immunity against certain disease germs; but this immunity is only temporary and is lost within a few months after birth. The immunity which adults possess usually is acquired after birth in one of the following ways:

*a. Natural Immunity.* A person may acquire immunity to certain diseases by becoming infected with the germs which cause those diseases. This infection may cause a typical case, or it may be so mild that the disease is not recognized. In either instance the body may build up resistance enough to protect the individual from contracting the disease a second time. But this protection develops only with certain infections, such as measles, mumps, diphtheria, and chickenpox. There are many diseases which do not produce effective or

lasting immunity and of which there can be repeated infections; examples: common cold, pneumonia, gonorrhoea.

*b. Artificial Immunity.* In the case of some infections which result in naturally acquired immunity, it is possible to stimulate this immunity by injecting a vaccine (weakened or killed organisms or their products) into the person's body. This process is called "vaccination" or "immunization." Usually, in order to obtain a protecting level of immunity it is necessary to give several doses of the vaccine at successive intervals of a few weeks or a few months. This is called the initial series. Thereafter, because the immunity is gradually lost, it is necessary to have "booster" doses at periodic intervals in order to restore an adequate level of resistance. At present, effective artificial immunization is available against a limited number of diseases, including smallpox, typhoid, tetanus, diphtheria, cholera, epidemic typhus, plague, yellow fever, and several others. Artificial immunization, however, does not provide absolute protection against the specific, given disease, nor does it protect against other diseases. Consequently, protective measures such as personal hygiene and sanitation must never be relaxed because of a feeling of security that one has been "immunized."

## **17. Army Immunization Program**

For protection against certain diseases, the Army requires that all soldiers receive immunizations.

*a.* While in the continental United States, all



military personnel are immunized against typhoid and paratyphoid fevers, tetanus, diphtheria, and smallpox. After the initial immunization series, booster doses are given from time to time to insure the maintenance of a protective degree of immunity.

b. Personnel scheduled for oversea duty are given additional immunizations, depending upon the area in which they are to serve. Special immunizations given most frequently to persons leaving the continental United States are against cholera, typhus and yellow fever.

c. The customary body site for immunization injections is the outer surface of the upper arm. After the injection, the surrounding area may become red, swollen, and painful.

## **18. Records of Immunization**

All immunizations are recorded on the soldier's immunization record. This form is given to the individual who has received the immunization. It is important that he preserve this record carefully and keep it readily available for inspection so that there may be no unnecessary repetitions of the injections.

## **19. Communicable Disease Control Measures**

The Army is vitally concerned with keeping the soldier mentally and physically fit. His commanding officer and his medical officer use every available means to make certain that he is given the best health protection available. In this effort all three factors involved in the spread of communicable diseases are taken into consideration;

namely, the source of disease, the transmitting agency, and the susceptible person.

## 20. Control of the Disease Source

This refers to measures that are taken to control sick individuals (cases), carriers, and animal reservoirs. These control measures include isolation, quarantine, medical surveillance, treatment and personal hygiene.

*a. Isolation.* This is a procedure whereby infected persons (cases or carriers) are separated from other individuals. Usually, this separation is accomplished by having the patient admitted to the isolation ward in the hospital. Clothing and linens that have been used by infected individuals must be laundered with soap and hot water. Other contaminated articles must be washed, scrubbed, aired, or sunned—as appropriate to the article. Mattresses and pillows should be sunned at intervals to destroy any bacteria that may be on them.

*b. Quarantine.* This is the restriction of freedom of movement of those individuals who may have been in contact with cases and who may themselves develop and further spread the disease.

*c. Medical Surveillance.* This measure may be carried out in two ways:

- (1) When cases or suspects of certain communicable diseases occur in a command, all contacts may be inspected daily during the incubation period of a disease in order to detect new cases of the disease that may be developing. Example: diphtheria; when found, such cases are iso-

lated immediately and treatment is started.

- (2) In the presence of a threatened epidemic, examinations of all troops may be ordered at stated intervals for the purpose of detecting early cases.

*d. Treatment.* When discovered, all cases of disease are treated. In this way the germs are destroyed and will not spread further.

*e. Personal Hygiene.* The spread of germs from infected individuals can be prevented or greatly reduced by a careful observance of the rules of personal hygiene—by strictly adhering to healthful habits and practices (ch. 7).

## **21. Control of Vehicle or Transmitting Agent**

To prevent the transmission of disease organisms, the following measures of environmental sanitation should be practiced as rigidly as possible.

- a.* Avoidance of overcrowding and close physical contact.
- b.* Proper ventilation of living quarters.
- c.* Water purification.
- d.* Careful selection and preparation of food.
- e.* Maintenance of mess sanitation.
- f.* Sanitary waste disposal.
- g.* Proper control of disease-bearing insects and animals.
- h.* Encouragement of the individual practice of personal hygiene.

## **22. Protection of the Susceptible Person**

This calls for the use of all measures necessary

to improve general health. It is a well-known fact that the individual who has good mental and physical health has good resistance to disease. Other protective measures include :

a. *Personal Hygiene.* The practice of personal hygiene will assist in preventing disease agents from entering the body (ch. 7).

b. *Immunization.* While this is an excellent method of control for some diseases (par. 17), it cannot be relied on completely but should be used in conjunction with other control measures.

c. *Prophylaxis.* Certain diseases which are acquired by personal contacts—particularly the venereal diseases—may be prevented by prompt cleansing of the contaminated parts of the body with soap and water. Other disease, like epidemic meningitis and malaria, may be prevented or suppressed by medication. This should be used only upon orders of competent medical authority.

## Section II. DISEASES OF MILITARY IMPORTANCE

### 23. General

The most important of the groups of diseases discussed in paragraph 11 are the respiratory, the intestinal, the insect-borne, and the venereal diseases.

### 24. Respiratory Diseases

Respiratory infections are the greatest cause of sickness in the Army. They occur the year round but are most common during winter and spring. While all troops are affected, the highest rates of infection occur among recruits and unseasoned troops.

## **25. Principal Respiratory Diseases**

The principal respiratory diseases are chicken-pox, smallpox, common cold, bronchitis, laryngitis, tonsillitis, diphtheria, measles, German measles, influenza, meningitis, mumps, pneumonia, scarlet fever, streptococcal sore throat, and tuberculosis.

## **26. Methods of Transmission of Respiratory Diseases**

Respiratory diseases are transmitted by secretions of the respiratory tract, particularly through close association with infected persons. The disease-producing organisms leave the body of the case or the carrier in small droplets of moisture during coughing, sneezing, or talking, and may be inhaled directly by other persons (droplet infection). Some of the smaller droplets lose their moisture by evaporation and become solid masses of dried germs. Being very light, these germ particles float in the air for long periods of time and, if inhaled, can cause disease (air-borne infection). Harmful organisms from the mouth or nose may also contaminate the hands, food, eating and drinking utensils, or towels from which they may be carried to the mouths of others.

## **27. Respiratory Disease Control Measures**

The principal difficulty in the prevention and control of respiratory diseases lies in the fact that most individuals are susceptible to them and that sometimes these diseases have been transmitted before the symptoms are noticeable. There are numerous measures used to control or reduce these diseases, and when used intelligently they are

quite effective. Most important among these measures are -

a. *Isolation of Cases.* Unless the medical officer advises otherwise, all known cases should be hospitalized or otherwise separated from healthy persons.

b. *Quarantine and Surveillance of Contacts.* These measures are carried out in the manner described in paragraph 20.

c. *Immunization.* This is an excellent preventive measure for such diseases as diphtheria and smallpox.

d. *Avoidance of Overcrowding.* It is a well-known fact that overcrowding, especially in the barracks, is an important factor in the spread of respiratory infections. There should be a space allowance of from 60 to 72 square feet per person. If individual space allowances are smaller, the number of cases of respiratory diseases may increase.

- (1) If beds are less than five feet apart, individuals should sleep head-to-foot. The purpose of this arrangement is to put as much distance as possible between the respiratory tracts of persons sleeping in adjacent bunks.
- (2) When respiratory diseases are present and crowding cannot be avoided, the individual cubicle system should be used. Bed cubicles are made by converting each bed space into its own compartment with the use of screens. The common method is to attach a pole to the head of

the bed and rig a shelter half to extend above the head of the bed with the lower edge folded under the mattress (fig. 3). Blankets and sheets may be used for this purpose instead of the shelter half.

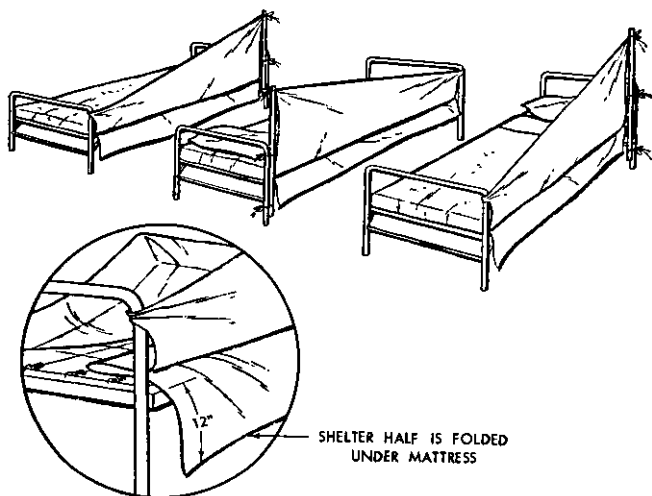

*Figure 3. Constructing cubicles in squad room.*

*e. Ventilation.* Good ventilation, either by natural or by mechanical means, has a double objective—health and comfort. Proper ventilation will dilute the number of bacteria in the atmosphere and thus reduce the number that may be inhaled.

*f. Dust Control.* Dust particles carry some germs. Germs from the nose and throat cling to the dust particles and may transmit infection by the air-borne route unless proper dust control

measures are carried out. To avoid raising dust, dry sweeping should be forbidden; water, wet sawdust, or sweeping compound should be used. Mopping can be substituted for sweeping. Oiling of floors is an excellent means of dust control.

*g. Personal Hygiene.* Each soldier is responsible for protecting his health as well as the health of his fellow soldiers by practicing good habits of personal hygiene. To remove germs, hands should be washed frequently with soap and water. When coughing or sneezing, the nose and mouth should be covered with a handkerchief. Drinking cups, canteens, towels, or any of the personal belongings of others should not be used. During the acute stage of a cold, close contact with others is to be avoided.

*h. Mess Sanitation.* Dishes, cooking utensils, and mess equipment must be cleaned and disinfected after each meal. Food handlers must be strictly supervised and trained in sanitary food-handling practices (ch. 6). They could infect others through the food they prepare or serve, therefore their personal hygiene is most important. Accordingly, each morning, or at the beginning of each work shift, all food handlers are inspected by the supervisor; individuals who are ill are sent to the dispensary and are returned to food handling duties only when they are no longer infectious.

*i. Prophylaxis.* As a prophylactic measure, certain drugs may be given to every member of the command for the purpose of combatting epidemic diseases—such as meningitis.



## **28. Intestinal Diseases**

Because they are usually caused by the contamination of food and water with human feces or urine, intestinal diseases are sometimes called "filth diseases." They result chiefly from poor hygiene and poor sanitation, both factors that can be controlled by good, common-sense practices of cleanliness. Persons who keep their hands and bodies clean and who consume only food and water that have been properly prepared and treated seldom develop these diseases. The problem of intestinal diseases exists in most parts of the world and requires constant vigilance, especially in areas where native sanitation is primitive. These diseases may affect large numbers of individuals at the same time and cause a serious loss of fighting strength.

## **29. Principal Intestinal Diseases**

Sometimes the terms "GI's," "abdominal cramps," or "diarrhea" are used to describe intestinal illnesses. The medical service, however, uses a more specific system of naming them, the following being the most important of the group: typhoid fever, paratyphoid fever, amebic dysentery, bacillary dysentery, cholera, and bacterial food poisoning.

## **30. Methods of Transmission of Intestinal Diseases**

The most common means of transmission of intestinal diseases are often referred to as the 5 F's: feces, fingers, flies, food, and fluids. The principal source of infection is the feces of man; but poultry, eggs, rodents, and fish may also be involved.

Infection may be spread in any of the following ways:

a. Food may be contaminated by infected food handlers who are careless or dirty in their personal habits; or by the housefly which carries germs directly from the latrine to the mess hall or the kitchen. Also, organisms may be carried directly to the mouth by feces-contaminated fingers.

b. Carcasses of beef, pork, chickens, and turkeys may be contaminated by germs from the intestines of these animals when they are being dressed. Eggs, especially duck eggs, can become contaminated by the fowl on the nest. Improper cooking then will allow the germs to survive and so infect those who eat these foods.

c. Natural sources of water, such as lakes and streams often are polluted by drainage from latrines and sewers. Springs and wells may be similarly contaminated. In the field, careless disposal of human waste is a frequent source of danger. Such waste material may drain into a nearby water source or furnish a breeding place for flies.

d. Rodents frequently urinate or defecate on foods to which they have access and in this way contaminate the foods with disease organisms.

### 31. Intestinal Disease Control Measures

a. *Responsibility.* Commanders of every level, including platoon leaders and noncommissioned officers, are responsible for enforcing sanitary regulations and taking all other necessary precautions against the spread of intestinal diseases.

b. *Methods.* The most effective method of preventing intestinal diseases is to control the

source and agencies which transmit them; namely, food handlers, human waste, flies, food, and water. Continuing and unrelaxing attention to the following measures is mandatory:

- (1) Good mess sanitation, including the careful selection, education, and daily inspection of food handlers.
- (2) Personal cleanliness; particularly washing the hands after each visit to the latrine and before eating or otherwise handling foods.
- (3) Careful selection, inspection, and protection of food supplies.
- (4) Strict supervision of the handling, preparing, cooking, and storing of foods.
- (5) Sanitary disposal of human and other wastes.
- (6) Effective fly and rodent control and the protection of foods against fly and rodent contamination.
- (7) Purification and protection of the water supply. All water is to be considered dangerous unless it has been properly treated.
- (8) Avoidance of unapproved food and water sources.
- (9) Immunization for typhoid and paratyphoid fevers and cholera. These immunizations must be kept up to date as specified for the various areas.

*c. Reporting and Investigating Outbreaks.*

Cases of intestinal disease should be reported to the unit medical officer as soon as detected so that

he may take the necessary steps to investigate the cause and avert a possible epidemic (fig. 4).

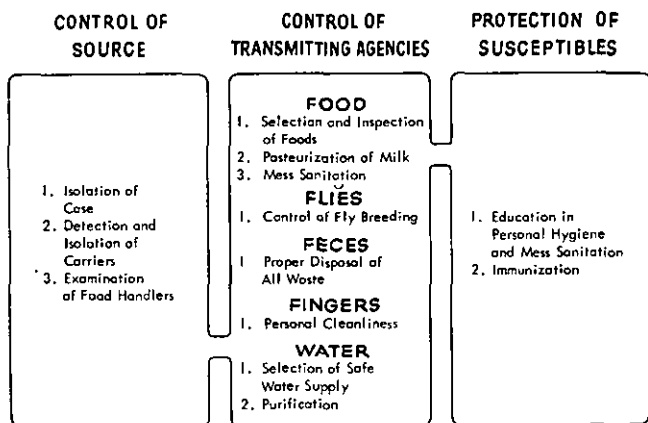

Figure 4. Factors in the control of intestinal diseases.

### 32. Insect-Borne Diseases

Arthropods include mosquitoes, flies, fleas, and lice which are properly "insects"; also the arachnids: ticks, mites, chiggers, spiders, and scorpions. Arthropods affect the health of man in four ways: (1) by transmitting disease agents, (2) by injecting venoms, (3) by invading living tissue, and (4) by annoyance.

### 33. Principal Arthropod-Borne Diseases

The principal arthropod-borne diseases include some of the commonest and most serious plagues of mankind, such as malaria, plague, yellow fever, and the typhus fevers. They are more common in the tropics, but may occur in most parts of the world. Uncontrolled, they can cripple large mili-

tary forces and often have done so. The principal arthropod-borne diseases and their transmitting agents are:

| <i>Disease</i>                  | <i>Transmitting Agent</i> |
|---------------------------------|---------------------------|
| Malaria -----                   | Mosquito                  |
| Yellow fever -----              | Mosquito                  |
| Dengue -----                    | Mosquito                  |
| Filariasis -----                | Mosquito                  |
| Encephalitis -----              | Mosquito (other insects)  |
| Typhus:                         |                           |
| Endemic typhus -----            | Fleas                     |
| Epidemic typhus -----           | Lice                      |
| Scrub typhus -----              | Mites (chiggers)          |
| Relapsing fever -----           | Lice and ticks            |
| Rocky Mountain spotted fever -- | Ticks                     |
| Tularemia (rabbit fever) -----  | Ticks and deer fly        |
| Bubonic plague -----            | Fleas                     |
| Sandfly fever -----             | Sand flies (Phlebotomus)  |

#### 34. Methods of Transmission of Insect-Borne Diseases

Disease agents are transmitted by arthropods in two general ways: the first—called mechanical transmission—is one in which the disease germs are picked up on the body or the legs of the arthropod vector and then are deposited on food, drink, or on open sores; an example of this method is the transfer of typhoid or dysentery organisms from fecal matter. The second—called biological transmission—is one in which the arthropod becomes infected by biting a diseased human or animal: the organism develops in the body of the arthropod vector and later is transmitted to a susceptible individual by a bite, as in the case of malaria; or, less commonly, by contamination of chafed skin with the body juices or feces of the

vector, as in the case of louse-borne typhus. The sting of certain species of bees, wasps, scorpions, and spiders injects poisons which can produce symptoms of varying severity. And when gnats, mosquitoes, flies, ants, and other pests become sufficiently numerous, they can affect the health of man by their continuous annoyance.

### **35. Arthropod-Borne Disease Control Measures**

Control measures are directed primarily toward the source of infection (humans and animals) and the transmitting arthropod. Since species of insects and arachnids differ from one another in their breeding habits, specialized knowledge is required to carry out effective control programs. We must know what stages a given insect goes through during its life cycle and when and where each of these stages occurs; also, where the weakest link in this life cycle is, so that we may attack with the greatest expectation of success. We must know which control measures are most effective against each kind of arthropod and where, when, and how to apply these measures. In the combat zone, each individual assumes responsibility for protecting himself from infection through the use of equipment and supplies which are issued to him for this purpose. By observing simple precautions, each soldier can do much to prevent disease.

### **36. Venereal Diseases**

Historically, venereal disease has been a problem of both civilian and military communities. It is of concern to the military because the soldier is removed from his home environment and may

travel to areas where promiscuity is common and the disease prevalent. Although with modern treatment these diseases are no longer such important causes of time lost, they may be serious to the individual who is affected.

### **37. Types of Venereal Diseases**

There are five commonly recognized types of venereal diseases, each caused by a different germ. The first three listed below are the most common.

- a.* Gonorrhea (clap, dose, gleet, strain)
- b.* Syphilis (pox, bad-blood, lues)
- c.* Chancroid (soft chancre, bubo)
- d.* Lymphogranuloma venereum (tropical bubo)
- e.* Granuloma inguinale (tropical sore)

An individual may contract more than one of these diseases as the result of a single exposure.

### **38. Methods of Transmission of Venereal Diseases**

Venereal diseases are almost always acquired by sexual contact with an infected individual. The lesions (sores) are usually on the genitals, and direct contact with the lesion or with material from the lesion is the usual method of transmission. In rare cases when an infected person has a lesion about the mouth, syphilis may be transmitted by kissing.

### **39. Venereal Disease Control Program**

An effective venereal disease control program is broad in its scope and depends on intelligent cooperation among many individuals. In the venereal disease control program of the Army,

particular emphasis is placed on the following measures:

*a. Responsibility.* The unit commander is responsible for initiating and maintaining a venereal disease control program within his command. His staff officers provide him with information and advice as to suitable control measures. But, because these diseases are transmitted by sexual contact, the real responsibility for prevention rests with the individual. Each soldier, personally, is responsible for the development and maintenance of his character, his self-respect, his personal hygiene, and his health.

*b. Character Guidance.* The Army character guidance program is an aid to the commander in promoting and maintaining a healthy mental and moral attitude in the personnel under his command. The program is designed to encourage the individual to develop moral responsibility and self-discipline. It is concerned with all of the soldier's interests and activities.

*c. Reduction of Sources.* Venereal disease cases that occur among military personnel are for the most part contracted from promiscuous women in the civilian population. In order to control the sources of infection, the Army must work closely with the civilian agencies concerned. The following methods can be used to reduce the sources of infection.

- (1) *Contact tracing.* All sexual contacts of a case of venereal disease should be examined and, if found infected, placed under treatment. In this manner the reservoir of infection can be reduced.



Men who have contracted a venereal disease are expected to supply information about the sex partner involved so that she too may be treated. This information is for the use of health authorities only and will not be disclosed; it is considered confidential and no disciplinary action will result.

- (2) *Use of "off limits" restrictions.* In order to decrease the possibility of contact, known houses of prostitution and establishments where "pick-ups" loiter must be placed "off limits" to military personnel (AR 600-900).
- (3) *Repression of prostitution.* Prostitution is not tolerated by the Army. The unit commander is responsible for securing full compliance with the spirit as well as with the letter of the regulations covering the repression of prostitution (AR 600-900).

*d. Continnence.* The most effective way of guarding against contracting venereal disease is to abstain from sexual relations outside of wedlock. Promiscuity increases the chances of developing venereal disease. The belief held by some people that sexual intercourse is necessary to maintain health is false.

*e. Education in Sex Hygiene.* All soldiers are instructed in matters of sex hygiene and the nature of venereal disease. Facts should be presented honestly and clearly.

*f. Prophylaxis.* Individuals who expose themselves to the risk of venereal infection should

employ as a measure of protection the materials and facilities recommended by the medical service. Good protection is afforded by mechanical prophylaxis (condoms, rubbers) if used properly. These are not items of issue but may be purchased in Army exchanges. The degree of protection may be increased by thorough washing with soap and water as soon as feasible after exposure.

#### **40. Treatment of Venereal Disease**

It is extremely important that all venereal diseases be reported to and treated by a medical officer. Most cases of venereal disease can now be cured if proper treatment is started early. Any sore on the genitals or any discharge from the penis may be a venereal disease; therefore, any such symptoms should be reported to the medical officer immediately. One should not seek outside help, or consult quacks, or try home or drugstore remedies. Contracting VD is not cause for disciplinary action and avoidance of the medical officer in such cases is the surest way to complications and disaster. However, a soldier who suspects or knows that he has venereal disease but fails to report for proper medical treatment, or one who violates "off limits" orders by entering a house of prostitution, is subject to disciplinary action.

# CHAPTER 3

## FIELD WATER SUPPLY

---

### Section I. GENERAL

#### 41. General

This chapter explains and stresses the importance of a safe water supply; outlines the measures taken to afford protection from diseases that may be transmitted by water; and furnishes information that will guide both the individual soldier and the various units in procuring their own supplies of safe water. If not properly treated, water may be a means of transmitting such diseases as cholera, the dysenteries, typhoid and paratyphoid fevers, and schistosomiasis (snail fever). Water may also carry organisms or germs which cause infectious hepatitis and poliomyelitis (fig. 5). Water that contains organisms which may cause disease is called "contaminated." Water that contains substances which are undesirable or render it unfit for drinking or

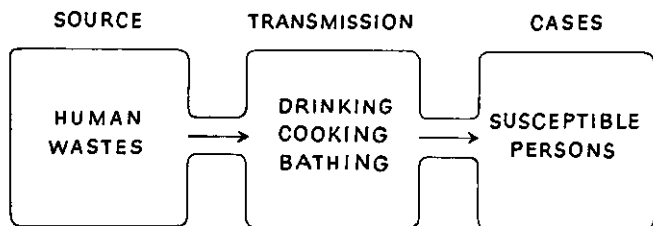

Figure 5. Spread of water-borne diseases.

domestic use is called "polluted." Water that is free of both contamination and pollution is called "potable." Any water consumed *must* be potable water.

#### 42. Responsibility

The Corps of Engineers is responsible for procuring and treating water. This responsibility includes the construction, maintenance, and operation of all facilities for collecting, purifying, and distributing water. Basically, the unit commander is responsible for the safety of the water used by his troops. When water treated by the Corps of Engineers is not obtainable, the commander must insure that proper water treatment methods are used by his unit. In addition, he must enforce water discipline; this means that his troops will drink only approved water, that they will not waste water, and that they will not contaminate or pollute water sources. Measures taken to purify water are supervised by the Army Medical Service. This supervision entails the making of sanitary surveys, the inspecting of the entire water supply system, and the testing of water to determine its quality.

#### 43. Quantity of Water

The amount of water necessary for any given number of persons varies. The season of the year, the geographical location, and the tactical situation are factors which must be taken into consideration when estimating minimum requirements. In a hot, dry climate, a man performing normal duty may require as much as two or three gallons of

water per day for drinking purposes; in a cooler climate, however, he may require only one-half to one gallon per day for the same purpose. Similarly, amounts required for cooking and for personal hygiene uses vary greatly.

#### **44. Sources of Water**

In the field, water may be obtained from surface water sources (lakes, rivers, streams, ponds); from ground water sources (wells, springs); and sometimes from public water supplies. When troops are moving rapidly, as in combat, there usually is not sufficient time to search for the most desirable water supply and advantage must be taken of whatever water is available, provided it can be purified with the material at hand. When time and the situation permit, a wider search for a better source is made. In some locations it may be necessary to use rain water, sea water, or melted ice or snow. The availability of water is a most important factor in the selection of bivouac sites and camps.

#### **45. Selection of Sources**

The selection of a water source depends on the quantity of water required, the accessibility of the source, the type of the source, and the type of water purification equipment on hand. If water is readily available and sources are free from unusual impurities, the order of preference in the selection of sources is as follows:

- a.* Public water supplies.
- b.* Existing wells or springs.
- c.* Surface water sources.

- d. Wells drilled by the Corps of Engineers.
- e. Distilled sea water.
- f. Snow or ice.

#### 46. Protective Precautions

Every member of the military forces must take the necessary precautions to insure the purity and sanitary condition of all water used, from the time it leaves its natural sources until it is consumed. Recommendations are made by the surgeon to the unit commander regarding the location and sanitary control of the water supply. Protective precautions as regards water supply are based on the considerations as set forth below:

##### a. *Location.*

- (1) A source should be selected which is as free as possible from known contamination.
- (2) When several otherwise equally desirable sources are available, the water that is easiest to purify should be chosen. Less personnel and equipment are required to purify water from a clean supply than from a supply of questionable quality.
- (3) A ground water source (well or spring) should be at an elevation higher than the surrounding ground and should be not less than 100 feet distant from possible sources of contamination such as latrines or soakage pits. Surface drainage should be away from the water source; otherwise, if the underground

formation is rock such as limestone, drainage from latrines or soakage pits may enter cracks in the rock and flow for distances great enough to contaminate the water source.

- (4) The water intake or the point of supply of a surface source should be as far away as possible from known sources of contamination. When a stream is used, the intake preferably should be upstream from any source of contamination. In lakes and ponds it is generally desirable to locate the intake as far from the shore as practicable, since the amount of contamination usually decreases in proportion with the increase of distance from the shore.

*b. Construction.*

- (1) *Surface water supplies.* Usually, water purifying equipment is furnished in complete sets. When setting up this equipment, certain precautions must be taken. It may be necessary to provide platforms of wood or other suitable material to keep fabric storage tanks from contact with the ground to prevent rotting of the fabric. Adequate drainage ditches should be dug to prevent water from collecting around the water purifying equipment.
- (2) *Ground water supplies.* When a well has been dug or drilled, its cover must be leakproof and so placed that it will not permit dirt, insects, or animals to enter

the well. When springs are used, the outlet at the surface should be boxed in, using concrete and a water-tight cover. This cover may be made of wood, sealed with canvas or sheet metal. The box should be provided with an outlet pipe. A ditch should be dug around the spring to prevent surface water from overflowing the protective cover.

*c. Operation.*

- (1) Water purification equipment must be operated properly. If the equipment is not operated in the correct manner, all of the care used in securing suitable location and construction will be of no value. The operator and the other responsible persons must make certain that their equipment is always kept in good working order and that the proper amounts of necessary chemicals are fed into the water.
- (2) After it has been treated, the water may be stored in several types of containers. Regardless of whether these containers are fabric storage tanks, lyster bags (fig. 6), or canteens, they must be kept clean and properly cared for. Containers and equipment used for delivery and issue of water should be so marked and should be used for those purposes only. If emergencies necessitate the use of other containers such as gasoline cans, these must first be thoroughly cleaned. They



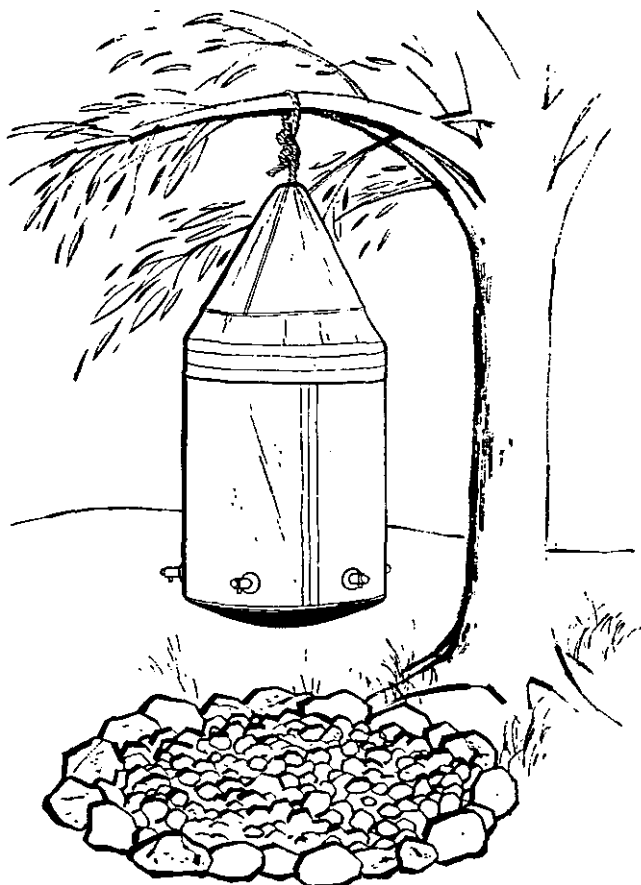

Figure 6. *Lyster bag.*

should be drained and then filled half full of water to which is added one ounce of powdered soap or three ounces of powdered activated carbon. The containers should then be shaken for five

minutes, rinsed thoroughly several times the last time to overflowing, and then emptied.

- (3) Lyster bags, storage tanks, and canteens should be inspected frequently and if found dirty should be scrubbed, treated with a strong solution of chlorine (1 glass ampul of calcium hypochlorite to 1 gallon of water), and rinsed several times with purified water. Canteens may be cleaned and then rinsed in boiling water.

*d. Sanitary Control.* The unit medical officer exercises supervision over certain protective measures pertaining to the water supply. These comprise:

- (1) Surveys and inspections of existing or proposed water supplies for possible sources of contamination.
- (2) Chemical analyses and bacteriological examinations of water provided to troops; this includes making on-the-spot residual chlorine determinations and sending samples to the nearest Army medical laboratory to be tested for harmful organisms or chemicals.
- (3) Technical supervision of procurement and purification of emergency field supplies for lyster bag or canteen treatment.

#### **47. Water Discipline**

Whether in the field or in garrison, each soldier is responsible for observing the rules of good water discipline. Three important rules are:

- a. Drink only from approved water sources. Untreated water usually is contaminated.
- b. Conserve water. Do not waste it.
- c. Do not contaminate or pollute water sources.

## Section II. WATER RECONNAISSANCE

### 48. General

"Water reconnaissance" is a term used to describe a search for suitable sources of water. For troops on the move, water supply sources are usually located by reconnaissance. If water sources are not known beforehand and the situation permits, reconnaissance is advisable for the purpose of locating suitable water sources in advance of the arrival of the main body of troops. The success of a military campaign may depend entirely on its water supply.

### 49. Responsibility

Since the Corps of Engineers is responsible for procuring and purifying water for major units in the field it is also responsible for water reconnaissance. The Army Medical Service furnishes necessary help and advice. However, when units are too small or too isolated to be able to receive this Engineer assistance, attached Army Medical Service personnel take over the water reconnaissance duty.

### 50. Sources of Information

a. When making a water reconnaissance, information must be obtained by every possible means such as—

- (1) Maps—especially those showing geographical or topographical information.
- (2) Aerial photographs.
- (3) Medical surveys—both military and civilian.
- (4) National and local government reports.
- (5) Intelligence surveys—Armed Forces and Federal departments.
- (6) Questioning of people who have been or who are living in the area.

*b.* All of the above and any other obtainable information should be investigated. In addition, an actual ground reconnaissance must be made whenever possible.

## **51. Reconnaissance Checklist**

*a.* As a rule it is necessary to study a water source to determine the amount of water available; the time and labor that will be necessary to develop the source; and the amount and kind of purification that will be needed, keeping in mind the type of purification equipment that is on hand. Principal points covered in a careful water reconnaissance are given below. Naturally, not all points will apply in a single situation; or, in some cases, additional data may be desirable.

- (1) Type of supply—well, spring, stream, lake, pond.
- (2) Location—sources of supply, facilities, and equipment; security, cover, and concealment.
- (3) Sources of contamination—character of contamination.

- (4) Quantity available—minimum, average, and maximum flow of streams, wells, or springs; dimensions and depth of lakes or ponds, with rate of outflow.
  - (5) Quality—color, turbidity (muddiness), odor, and taste; bacteriological examinations and/or chlorine demand tests.
  - (6) Accessibility—nearness of supply to troops by rail or road; condition of access roads.
  - (7) Plans for development—time, labor, and material necessary to develop the source.
- b. It is further necessary to check the following details:
- (1) Wells—diameter; depth of well; depth of water level; type; condition and type of casing; nature of ground structure; productive capacity; method of raising water.
  - (2) Springs—type; natural; protection; surface drainage; rate of flow.
  - (3) Streams—minimum, maximum, and average rate of flow; width and depth; nature of stream bed; height of banks above water; access.
  - (4) Existing water systems—purification equipment (chlorinators, filters, etc.); type, size, speed, and capacity of pumps and engines; electrical equipment; storage facilities; pipelines; description of general condition of the facilities.

## **52. Maps and Conventional Signs**

Data secured by the accomplishment of a water

supply reconnaissance have more meaning when they are recorded accurately on pertinent maps and when the conventional military symbols and signs are used, which are described in FM 21-30.

### Section III. FIELD WATER PURIFICATION

#### 53. Engineer Water Treatment

Water supplied to troops from Corps of Engineer water points has been treated to make it potable. Treatment usually consists of sedimentation, filtration, and disinfection by chlorination.

*a. Sedimentation.* Sedimentation is a process by which the suspended impurities (mud, sand) in water are settled out. This is done by filling a storage tank or basin with raw water and then allowing it to stand for an hour or more. The suspended impurities settle to the bottom of the tank and the clearer water above may be drawn off for filtering. This process is usually aided by the addition of special chemicals to the water so as to make the particles settle faster.

*b. Filtration.* Filtration removes the suspended impurities which remain after sedimentation. It also removes of the organisms or germs. The filtering or straining material is usually diatomaceous earth.

*c. Chlorination.* Disinfection by chlorination kills any disease-producing organisms which have not been removed by sedimentation and filtration.

#### 54. Engineer Water Treatment Equipment

In order to accomplish its mission of supplying safe water, the Corps of Engineers has developed

special equipment, described below, for the treatment of water under field conditions.

*a. Diatomite Filters.* These filters use a fine powder, diatomite or diatomaceous earth, as a filtering material. A thin layer of diatomite is applied to the surface of the elements in the filter through which the water passes. As the water is pumped through this material, most of the suspended impurities and organisms are removed. When the diatomite layer becomes too dirty, the flow through the filter is reversed and the used diatomite is flushed out. Before filtering again, a new layer of diatomite is applied to the filter elements. These filters are issued in two sizes: 15 gpm (gallons per minute) and 50 gpm. The 15-gpm "pack" diatomite filter can be transported by nine men or three pack animals. The 50-gpm "portable" diatomite filter is the one used most often at Corps of Engineers water points. Both of these filters, properly operated, will remove the organisms that cause amebic dysentery and schistosomiasis.

*b. Knapsack-Pack Water Filter Unit.* This unit was designed to provide small, isolated troop units, such as parachute troops or patrols, with potable water. It produces only one quart of water per minute. This filter unit, if properly operated, will also remove the organisms that cause amebic dysentery and schistosomiasis. Paper pads are used for filtering.

*c. Hypochlorinators.* These devices are used to feed chlorine solutions, at a constant rate, into the water that leaves the filter. A hypochlorinator consists of a chemical chamber and a small pump

which forces the disinfecting solution into the filtered water.

*d. Storage Tanks.* Most Corps of Engineer portable storage tanks have a capacity of 3,000 gallons. They are made of canvas or of rubberized fabric supported by wooden staves. These tanks are used for settling water before it is filtered and for storing the treated water.

*e. Pumps.* For most purposes, the 55-gpm portable pump is used. This pump is powered by a 1-cylinder gasoline engine.

*f. Distillation Equipment.* This equipment is used to produce fresh water from sea water. Water that has been distilled should be disinfected by chlorination as there is no protection against recontamination. Producing fresh water from sea water is not an economical process and is not used where other sources of fresh water are available. For additional information on Engineer water supply equipment, see TM 5-295.

## 55. Chlorination

All water that is to be used for drinking purposes should be disinfected. Normally, chlorine is used for this purpose. Chlorine may be supplied as a compressed gas in cylinders; but in the field the powdered form, calcium hypochlorite, is generally used. Calcium hypochlorite is furnished in bulk containers and in glass ampuls which contain 0.5 gram of powder. When the powder is dissolved in water it releases chlorine which kills bacteria. As the bacteria and other organisms are killed, the chlorine is used up. If enough chlorine has been added to the water, some will remain



after the organisms are killed. This remaining amount is called the "chlorine residual." To determine the thoroughness of disinfection, the chlorine residual may be measured by simple tests.

a. *Required Chlorine Residuals.* Under ordinary field conditions, a chlorine residual of 1.0 ppm (parts per million) after 10 minutes of contact time is required in all drinking water. In areas where amebic dysentery, infectious hepatitis or schistosomiasis are prevalent, the chlorine residual must be increased to 2.0 ppm or more after 10 minutes of contact time. In any case, the water should not be used until 30 minutes have elapsed after the addition of the chlorine.

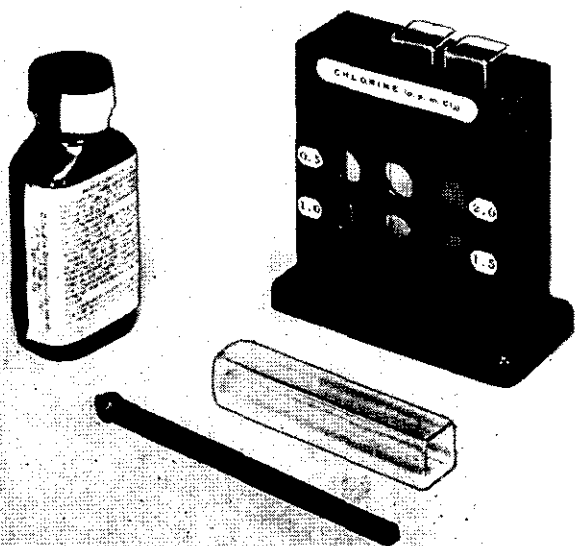

*Figure 7. Chlorine comparator.*

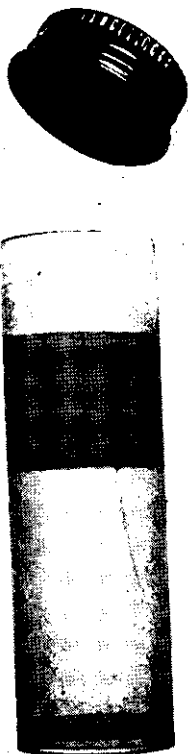

*Figure 8. Comparator (plastic tube).*

*b. Residual Tests.* Chlorine residuals are determined by the use of a chemical called orthotolidine. This chemical is added to the water and the resulting color is compared with established color standards. For this purpose a device called a comparator is used. This test kit contains vials, a bottle of orthotolidine solution or tablets, and small colored glass disks corresponding in color to

various chlorine concentrations. By following the directions carefully, chlorine residuals in parts per million (up to 2 ppm with most sets) can be read directly from the comparator (fig. 7). A simpler type of comparator consists of a plastic tube and a small bottle of orthotolidine tablets. The plastic tube has a yellow band around the top. For water testing purposes, the tube is filled with water to the bottom of the yellow band. One orthotolidine tablet is added and the tube is closed and shaken until the tablet is dissolved (fig. 8). An equal or slightly darker yellow than the color of the band indicates a chlorine residual of about 1.0 ppm. If a lighter color or no color is formed, the water does not have a sufficient chlorine residual. If the color formed is a deep yellow or orange, the chlorine residual is greater than 1.0 ppm.

## 56. Emergency Water Supply

Isolated units may not be able to obtain water from established water points and therefore they must obtain and treat their own water. Usually, the available sources of supply will be ponds, lakes, streams, shallow wells or municipal water distribution systems. The source that appears to be the cleanest should be selected. Well water is likely to be clearer than surface water. When surface water is used, care should be taken to avoid getting mud from the bottom, or picking up floating sticks, leaves, or other debris. Turbid or cloudy water should be settled before it is used. A settling basin may be constructed by digging a trench, parallel to the stream bank, into which the water may seep and remain still. Another method is to dig a short

ditch from one side of the stream leading to a basin where the water can stand and settle. After the dirt has settled the clear water may be disinfected by chlorination or by being boiled vigorously for one minute. Chlorination may be accomplished by the use of lyster bags and ampuls of calcium hypochlorite (fig. 9). The lyster bag (fig. 6) is a 36-gallon canvas container, issued on a basis of 1 bag per 100 men. The porous canvas permits cooling of the water by evaporation. This bag can serve as a clean storage tank, as a con-

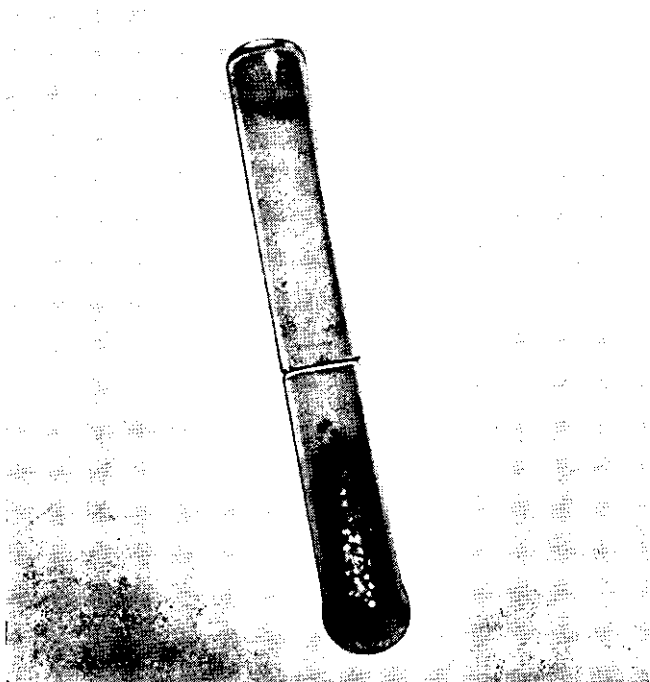

*Figure 9. Calcium hypochlorite ampul.*

venient dispensing point for water which has been purified by other means, or as a container for disinfecting raw water. When using the lyster bag for disinfection, the procedure described below should be followed:

*a.* Clean the bag before using and hang it by the supporting ropes as illustrated. Fill the bag to the 36-gallon mark (which is 4 inches from the top of the bag). Use clear, settled water, if possible.

*b.* Pour the contents of a calcium hypochlorite ampul into a canteen cup; add a small amount of water from the lyster bag and stir with a small stick until a thick mixture results; then fill the cup two-thirds full of water.

*c.* Empty the prepared solution slowly into the lyster bag, stirring the water with a clean stick. This solution gives a chlorine dosage of 2.5 parts per million. Cover the bag and clean the faucets by flushing a small quantity of the water through each of them.

*d.* After the disinfecting solution has been in contact with the water for 10 minutes, flush the faucets and collect a sample of water from one of them to determine the chlorine residual. Do not collect the sample in the cup that was used for mixing the chemical. The chlorine residual should be not less than 1.0 ppm. If the residual is too low, add an additional ampul of calcium hypochlorite and repeat the test after 10 minutes.

*e.* If the chlorine residual is satisfactory, wait an additional 20 minutes before drinking the water. This will give a total disinfection time of 30 minutes.

If a lyster bag is not available, other clean containers may be used. The chlorine dosage should be proportionate to the amount used in the lyster bag: that is, 1 ampul to 36 gallons of water.

### **57. Individual Water Supply**

When other sources of safe water are not available the individual soldier may produce his own potable water by using his canteen and individual water purification tablets or the calcium hypochlorite ampuls discussed above. By following directions printed on the bottle containing the tablets, water of questionable quality may be made potable. Normally, 1 iodine tablet is used per canteen of clear water, and 2 iodine tablets per canteen of cloudy water. When using calcium hypochloride ampuls, proceed as follows:

a. Put one ampul in a canteen of water, leaving a small air space in the canteen, and dissolve it by thorough shaking.

b. Fill a canteen cap with the solution and add this to each canteen of water to be disinfected; then mix thoroughly.

c. Allow the water to stand at least 30 minutes before drinking.

### **58. Special Treatment Methods**

In certain areas of the world, surface water may be contaminated with amebic cysts which cause amebic dysentery, or with young forms of the schistosome worm which causes schistosomiasis. In such areas the special water treatment processes described below should be used.

a. *Amebic Dysentery (Amebiasis)*. This dis-

ease is worldwide in occurrence but is generally more prevalent in the tropics. It occurs most often where lack of sanitation permits human feces to get into food or water. In areas where this disease is a problem, surface drinking water should be purified by the following methods:

- (1) *Sedimentation.* Settling tanks should be placed ahead of the filters and chemicals added to the water to aid the settling. Normally, the sedimentation period covers at least one hour.
- (2) *Filtration.* If properly operated, the diatomite filters described in paragraph 54a will remove amebic cysts.
- (3) *Disinfection.* After filtration, special field chlorination policies are followed (that is, the water must contain at least 2 parts per million of residual chlorine after 10 minutes of contact time plus an additional lapse of 20 minutes before using).
- (4) *Emergency water treatment.* When small units must treat their own drinking water, boiling is one sure method. The use of the lyster bag is also safe, provided additional special treatment measures are taken, as follows: First, apply the necessary amount of calcium hypochlorite to get one part per million of residual chlorine after 10 minutes of contact time; then add another tube of calcium hypochlorite immediately after the first satisfactory test. An additional contact period of 30 minutes should be al-

lowed before the water is used. To disinfect water in individual canteens, follow the same directions given in paragraph 57 for individual purification, unless an increase in dosage is directed by the medical officer.

b. *Schistosomiasis (Called Snail Fever Because the Parasites Come From Snails)*. This disease is caused by the tiny larvae of worm parasites, called blood flukes. These flukes are found in the Far East and in certain tropical countries. They can penetrate the unbroken skin while a person is wading or bathing in contaminated water. In areas where this disease occurs, water from deep wells and springs should be used, if possible. When infected water must be used, the following precautions should be taken:

- (1) *Water treatment*. Drinking water should be treated in the same manner as described for amebic dysentery. Careful diatomite filtration will remove the organisms. When filtration equipment is not available, chlorination to 2 parts per million of residual chlorine after a 30-minute contact period should be used. To disinfect water in canteens, follow the same directions given in paragraph 57 for individual water purification, unless an increase in chlorine dosage is directed by the medical officer.
- (2) *Water handling protection*. Troops who handle raw water supplies suspected of containing these organisms should wear rubber gloves and boots. Parts of the



body which have been wetted by untreated water should be rubbed briskly with a coarse towel or cloth.

- (3) *Bathing and swimming.* The same measures that apply to drinking water apply with equal force to water for bathing purposes. Swimming or wading should be avoided in natural bodies of water suspected of containing these organisms.

## 59. Ice and Beverages

Water used for making ice and cold beverages must be potable. Beverage powders do not purify water nor does freezing make the ice safe. Only ice that has been approved by a medical officer should be used.

# CHAPTER 4

## IMPROVISED SANITARY DEVICES

---

### Section I. GENERAL

#### 60. General

Normally, the Army issues the equipment needed for proper military sanitation. This equipment includes water heaters, washing devices for mess gear, hand-washing facilities, showers, and laundries. In the field these sanitary devices at times will be lacking. In such cases the necessary devices and facilities must be improvised so that health may not suffer. Improvised devices which have been tried and used in the field successfully are described in the sections that follow. Given as general guides, they will be found useful in solving sanitation problems.

#### 61. Fuel Requirements

For providing hot water, a supply of fuel and a device to change the fuel into heat are needed. The two types of fuels commonly available are solid fuels (coal and wood) and liquid fuels (oil and gasoline).

### Section II. WATER HEATERS

#### 62. Fire Trench

When solid fuels are used, a fire trench is one of the easiest methods used for heating (fig. 10). The trench should be about 1 foot wide and 1 foot

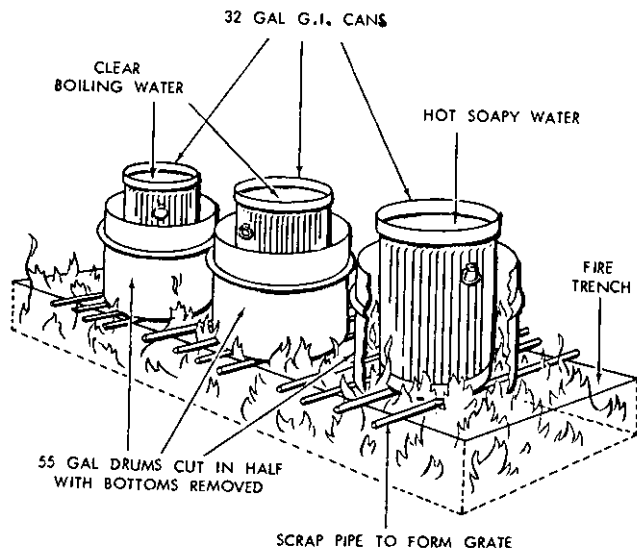

Figure 10. Mess kit washing setup with fire trench.

deep. Its length will depend on the number of water cans to be heated. For three cans, usually a trench 8 feet long is sufficient. The cans, supported by steel rods and pipes, are placed over the trench and the fire is built in the trench. This method uses a great amount of fuel and should be used only when wood or coal is abundant.

### 63. Flash-Type Oil-Water Burner

a. The flash-type oil-water burner uses diesel or motor oil as fuel. In cold climates it may be necessary to thin these oils with gasoline or kerosene to obtain a good flow. The burner consists of a metal burner plate, a feed pipe, and containers for oil and water (fig. 11). The containers are

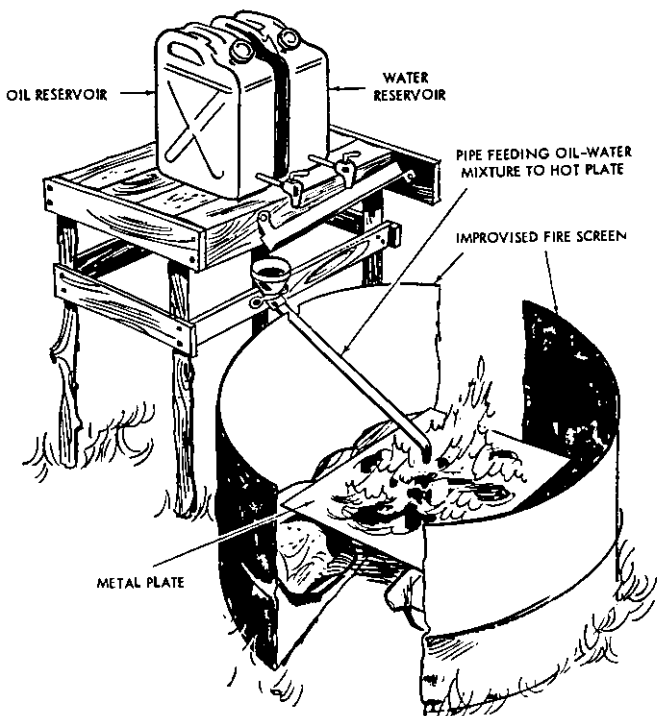

Figure 11. Flash-type oil-water burner.

equipped with valves, taps, or plugs for controlling the rate of fuel flow and water flow.

b. Operation of this burner results from dropping a mixture of oil and water (generally about 4 parts of oil to 1 part of water) on a metal plate which has been preheated to the flash point of the oil. (Flash point is that temperature at which a liquid fuel bursts into flame.) The addition of water in small amounts increases the efficiency of

this burner as the water becomes steam when it hits the heated plate. This steam aids burning by shattering the oil into very small droplets which will burn more readily than would larger drops of oil. The burner plate is preheated by burning waste material under it before adding the oil-water mixture. When the plate becomes hot, the oil-water mixture is allowed to drip slowly onto the plate. A hot flame may be obtained by adjusting the individual streams of oil and water. Very little smoke or odor is produced when the burner is operating properly. Since this burner is very sensitive to strong drafts, rain, or anything that will cool the plate, shields should be on hand to protect the ends of the burner. If sheet metal for making these shields is not available, a simple protecting wall of stone or earth should be built. If waste motor oil is to be used as fuel it should be strained through a screen or a cloth before it is added to the oil container to remove sludge and lumps that might block the drip valves.

#### **64. Vapor-Type Burner**

*a.* The vapor-type burner uses liquids such as diesel oil, kerosene, or gasoline, or a combination of these. As with the flash-type oil-water burner, it may be necessary in cold climates to thin the heavier fuels with gasoline before use. For the construction of this burner it is necessary to have several sections of pipe, a valve, pipe fittings, and a fuel reservoir (fig. 12). The operation of the vapor-type burner depends on vaporization of the fuel by preheating before burning. Burning of the fuel which escapes from the lower pipe of the

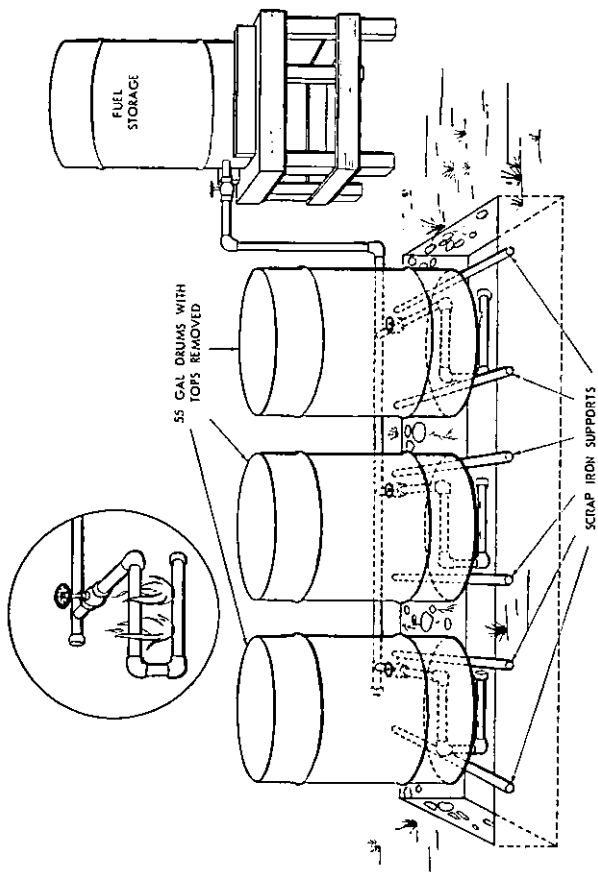

Figure 12. Vapor-type burner.

burner heats the fuel in the upper pipe, causing the fuel to vaporize into a gas. This gas produces pressure in the lower pipe and forces the fuel out through small holes as a spray, thus producing a better flame. For best operation, the pipes should be placed in a fire trench. The trench should be about 1 foot wide and 15 inches deep. The pipe is assembled in such a manner that it is doubled under itself. The best size pipe to use is either one-half or three-quarters of an inch in diameter. Very small holes ( $\frac{1}{16}$  inch or less) are drilled in the top of the lower pipe at points under the containers. The end of the pipe is capped so that fuel can escape only from the drilled holes.

*b.* To operate the burner, the valve which controls the flow of fuel is opened to allow a small amount of fuel to run out through the holes in the bottom pipe. This fuel, when ignited, heats the upper pipe and starts the fuel-heat-gas pressure cycle described above. A properly operated burner will produce a blue flame. A yellow flame indicates incomplete burning; this is caused by too much fuel escaping from the holes and may be corrected by lowering the pressure in the line, either by reducing the size of the holes or by lowering the rate of the flow. If the flame is blue but tends to blow itself out, it indicates that the flow is too small. To correct this condition, increase the pressure in the line, either by enlarging the holes or by increasing the rate of the flow. The pressure in the line is increased by raising and decreased by lowering the fuel container. A section of oil drum may be placed around the water container to direct the flame for better heating.

## 65. Modified M-1937 Heater

a. Modification of the heating unit from an M-1937 field range will permit its use to heat water for washing mess kits. One heating unit can then be made to do the work of three. This modification consists of using a U-shaped pipe as shown in figure 13. The M-1937 heating unit is

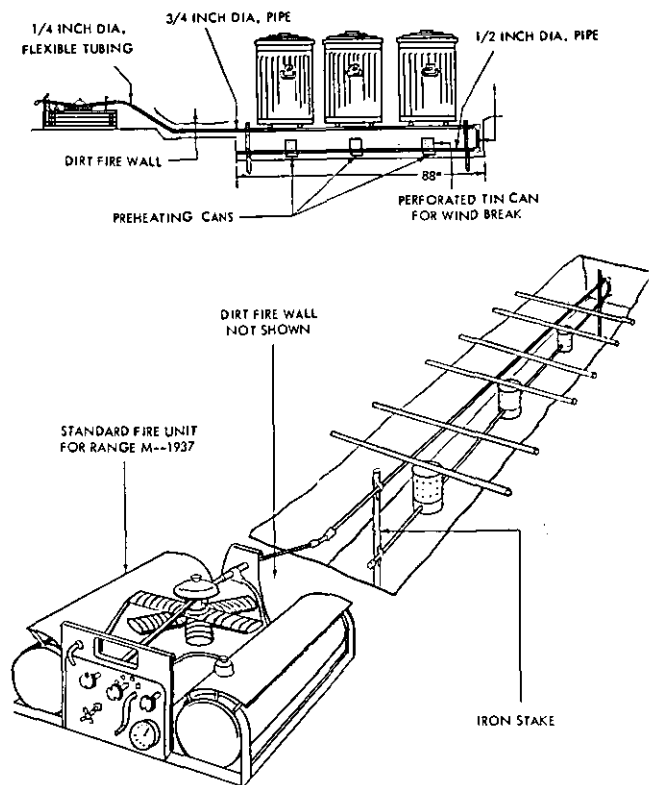

Figure 13. *Improved gasoline burner for washing mess kits.*



connected to the pipe by suitable fittings. At intervals of from 36 to 48 inches (sufficient to permit the cans of wash water to be set over them) three very small holes are drilled in the lower pipe. These holes should be about the size of a bristle in a wire brush. It is also important to provide perforated shields around the holes as shown. The shields can easily be made from No. 2 size tin cans.

*b.* When in operation, the gas tank in the heating unit should be filled approximately three-fourths full and the air pressure in the pressure tank should be pumped to 45 pounds per square inch in warm weather or 60 p.s.i. in cold weather (subfreezing). The portions of the lower pipe inside the shields and around the small holes should be preheated by igniting about a cupful of gasoline underneath them. This will also preheat the upper pipe. The control valve on the tank is opened about one-quarter turn; ignition will then occur; and in 2 or 3 minutes a steady blue flame will result. The burner control and air valves on the M-1937 unit remain closed.

## **66. Operation Hazards**

Whenever gasoline or oil heaters are used there is potential danger of carbon monoxide poisoning, lead poisoning, or explosions; therefore only experienced personnel should be permitted to operate improvised oil and gasoline burners.

*a.* Carbon monoxide is a colorless, odorless gas which is given off by the burner when combustion is incomplete. This hazard may be eliminated by proper operation of the equipment and adequate ventilation.

b. Lead poisoning may result from the use of a leaded fuel, such as ethyl gasoline. The inhaling of vapors given off by the burner is particularly dangerous. Adequate ventilation, therefore, is absolutely necessary.

c. Serious explosions may result from improper operation of these burners. If the flame goes out and the fuel is not turned off or relighted immediately, a dangerous concentration of gas will build up in the trench which if ignited will result in an explosion. This danger is not as great with the flash-type oil-water burner as it is with the vapor-type burner. For reducing explosion hazards with the vapor-type burner, an automatic relighting device may be improvised. This is done by wrapping a few coils of iron wire around the feed line and the burner line at the holes. After the burner has operated for a few minutes this wire becomes red hot; and if the flame goes out, the heat from the wire will relight the fuel. Also, the explosion hazard in the tank will be considerably decreased if the level of the fuel is not allowed to fall below the half-full mark.

### Section III. MESS GEAR WASHING DEVICES

#### 67. Introduction

After each meal, mess gear should be cleaned and sterilized. This means that all visible particles of food and grease are removed and all harmful organisms killed. To accomplish this, mess gear is washed first in hot, soapy water and then rinsed in two separate containers of clear, boiling water.

In each of the devices discussed in paragraph 68, three containers are required.

### 68. Washing Devices

When GI cans are not available, mess gear washing devices may be constructed with the use of metal drums as described in *a*, *b*, and *c*, below. In each case, any one of the heating devices listed in paragraphs 62 through 66 may be used as heaters.

*a. Drums Cut Crosswise.* Use the larger part (about  $\frac{2}{3}$  of the drum) as the water container. Cut out the end of the smaller part (about  $\frac{1}{3}$  of the drum) and use it as a support. This part may also serve as a shield for the burner. If the vapor-type burner is used, cut the bottom edge of the lower part of the drum so that it fits tightly around the pipe.

*b. Drums Cut Lengthwise.* In this setup, the drums are placed directly on a trench. A chimney may be used to improve the draft of air. This will result in a hotter and cleaner fire.

*c. Drums Cut Two Ways.* When setting up a more permanent facility, a method in which the drums are cut in two ways may be used. The drums to be used as water containers are cut lengthwise, so that one-third of the drum is removed. The drums to be used as supports are cut so that only one-fourth of the drum is removed. The drums are then fitted together and the sides of the supporting drums may be insulated with suitable materials. As this device operates best with the vapor-type burner, holes should be cut through the ends of the supporting drums near the

bottom to permit the passage of burner pipes under the containers. Because of the close housing around the burners, this is a very efficient device.

## 69. Drainage Devices

As an aid in draining the washing units, one of the following devices may be used:

*a.* Connect all three cans to one central outlet pipe. When the washing has been completed, the valve may be opened and the water drained out. The water so removed should be passed through a grease trap and then into a soakage pit (pars. 119-123).

*b.* Cut a hole in the bottom of the drum and weld a pipe coupling into its place. Screw a short piece of pipe, about four inches longer than the depth of the water, into the fitting. This pipe should be screwed in by hand so that it can be removed easily. When the drum is to be drained, the pipe is removed. With this arrangement it is necessary to build a soakage pit under the device, or to construct a trough under the containers, and run the water into a grease trap and then a soakage pit.

## Section IV. HANDWASHING DEVICES

### 70. Introduction

Handwashing devices should be provided outside latrine enclosures and near or adjacent to kitchens. They may also be set up at other points in a bivouac area. To encourage their use they should operate easily and should be kept filled with

water at all times. Two cans should be provided and both containers checked frequently to see if refilling is needed. All of these devices should have a shallow area dug out under the outlet, which area should be filled with small stones. This will prevent the water from gathering into pools.

### 71. Improvised Devices

The simplest handwashing devices may be made from salvaged 5-gallon water cans or from No. 10 size food cans.

a. When using 5-gallon water cans, punch a hole in the cap and suspend the can from a support. By having the cans arranged as shown in

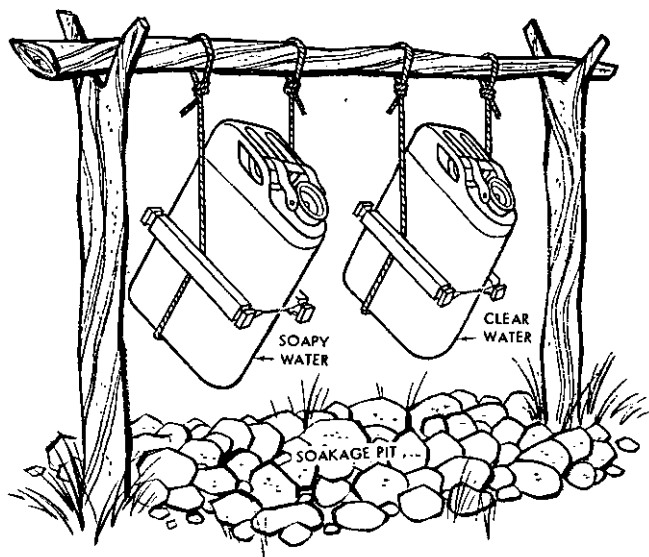

Figure 14. Handwashing device, using 5-gallon water cans.

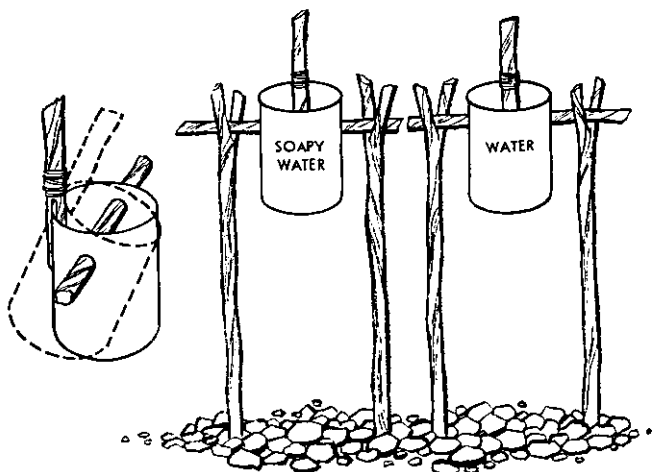

Figure 15. Handwashing device, using No. 10 can.

figure 14, they may be tipped to permit a flow of water.

b. No. 10 size food cans may be arranged as shown in figure 15. Wooden rods are run through the tops of the cans; the ends of the rods are supported by forked sticks. The handles are made from small sticks which have had one end split. These are fitted over the back of the cans. As these cans hold only small amounts of water, the water must be constantly replenished.

## Section V. SHOWER FACILITIES

### 72. General

Whenever possible, showers should be provided. They are important not only for personal hygiene but also as factors for maintaining the morale of a

unit. In hot weather, heat from the sun may be used to take the chill from shower water. Painting the containers black or some other dark, dull color will increase the absorption of heat from the sun. However, when large amounts of hot water are needed, the water heaters described in paragraphs 62 through 65 will be found necessary.

### 73. Improvised Shower Facilities

There are many ways to arrange for showers when a unit is in the field. The devices shown here are but a few of those that have been improvised and found useful.

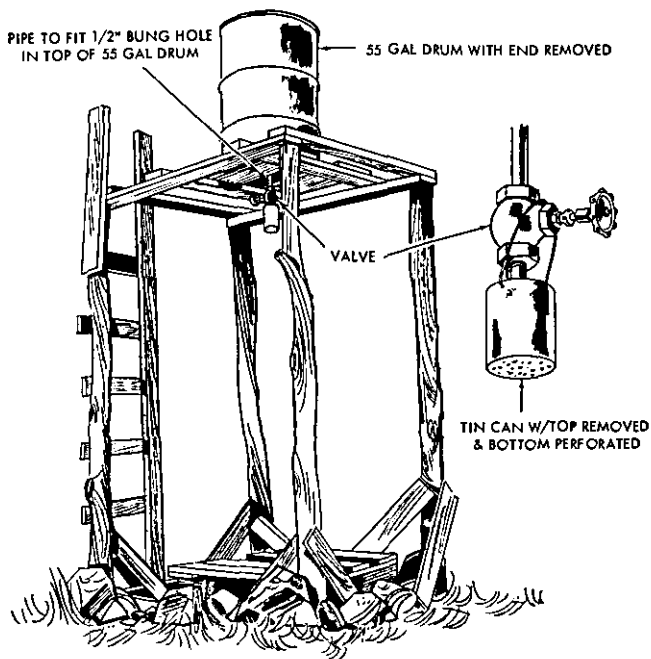
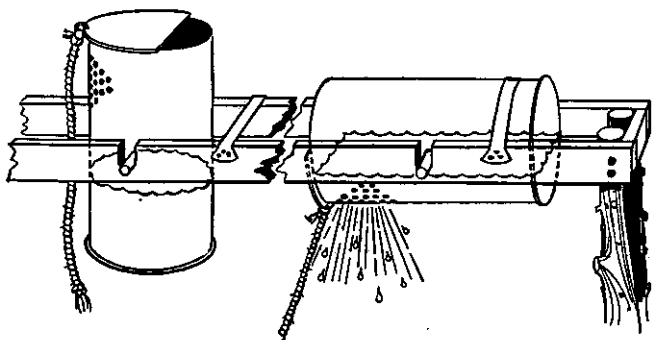

Figure 16. Shower unit, using 55-gallon drum.

a. Figure 16 shows a metal drum placed on an overhead platform. Shower water is drawn off through an outlet fitted into the bunghole. A small can with one end removed and the other end perforated serves as a shower head.

b. Another method of using the metal drum is shown in figure 17. In this shower, the drum itself has been perforated. Pulling down on the rope which is attached to the top of the drum tips the drum and operates the device.



*Figure 17. Shower unit, using metal drum.*

c. A simple method of supplying hot water for showers is the convection type hot water heater shown in figure 11, and described in paragraph 63. With this arrangement a mixture of hot and cold water is obtained for the shower. The water lines may be made from rubber tubing or from metal pipe. Heating the water in the lower container causes hot water to rise up the riser pipe. This hot water is replaced in the heating container immediately by an equal amount of cold water.



# CHAPTER 5

## WASTE DISPOSAL

---

### Section I. GENERAL

#### 74. General.

*a.* "Waste" is a general term covering all types of refuse resulting from the living activities of humans or animals. In this chapter the following types of waste will be considered:

- (1) Human wastes (feces and urine).
- (2) Liquid wastes (kitchen, bath, and wash water).
- (3) Garbage.
- (4) Rubbish.

*b.* Since the method of disposal depends on the military situation and unit location, several means of disposal are indicated for each type of waste. Under field conditions, burial or burning are the means most commonly used.

#### 75. Medical Importance of Waste Disposal

The total weight of wastes of all kinds, including liquid wastes, produced under field conditions approaches 100 pounds per man, per day. If this material were not removed promptly and thoroughly, a camp or bivouac would soon become a smelly, filthy dump. Filth-borne diseases such as dysentery (amebic and bacillary), typhoid, paratyphoid, cholera, plague, and others might become prevalent. Flies, rats, and other vermin would in-

crease and add to the individual's discomfort as well as endanger his health. Even with the relatively good sanitation maintained in the American Army camps of World War II, records show a total of nearly 1,000,000 hospital admissions for filth-borne diseases during that period.

## **76. Responsibilities**

*a.* Unit commanders are responsible for the disposal of waste from their unit areas. When waste disposal facilities are not otherwise provided, the commanding officer must arrange for the construction and operation of such facilities.

*b.* The Army Medical Service inspects waste disposal facilities and operations and recommends such changes as will aid in protecting the health and welfare of the troops.

*c.* The Corps of Engineers constructs and operates waste disposal facilities at permanent and semipermanent camps. In the field, the provision of these facilities is the responsibility of the unit commanders.

*d.* The Quartermaster Corps stores and issues certain items that are necessary for the proper disposal of wastes.

## **Section II. HUMAN WASTES**

### **77. General**

*a.* Human wastes consist primarily of urine and feces. The accumulated excrement of a group of humans or animals will contain disease-producing germs. This filth with its content of germs may enter the body in any of the following ways:

- (1) From food, water, beverages, and eating utensils which may have been contaminated by feces, by the fingers of food handlers, or by flies and other vermin.
- (2) From hands, when personal hygiene is not practiced (ch. 7).
- (3) From close physical contact with unclean persons. The above includes what are known as the classical 5 F's of filth-borne disease transmission: feces, fingers, flies, food, and fluids.

b. The basic principles in the control of filth-borne diseases are:

- (1) Prompt, thorough, and permanent disposal of urine and feces.
- (2) Observance of the practices of personal hygiene, giving particular attention to cleanliness in finger habits, cleanliness of clothing, and cleanliness of hands and body.
- (3) Prevention of the contamination of food, water, beverages, and eating utensils by fingers or by flies and other vermin.
- (4) Disinfection by boiling, or by chemical means, of eating utensils, food and water which may have become contaminated.

c. The methods of human waste disposal will vary with the situations. At permanent and semi-permanent camps, water-borne sewerage systems like those of our cities are provided. Away from these bases, military units must adopt methods discussed below.

- (1) On the march, the "cat hole" latrine is used. The individual digs a hole about a

foot deep, then replaces the earth over the feces.

- (2) In bivouacs and in overnight camps, urine and feces are disposed of by the use of straddle trenches.
- (3) In temporary camps, usually deep pit latrines and urine soakage pits are constructed. Until the construction of deep pit latrines has been completed, straddle trench latrines may be used. Where the construction of deep pit latrines is not practicable some of the other devices listed in this chapter may have to be used. Whatever the type used, the unit is responsible for its own latrine construction, maintenance, and closure.

*d.* The devices most generally used for disposal of human waste in the field are—

- (1) Straddle trench latrines.
- (2) Deep pit latrines.
- (3) Mound latrines.
- (4) Bored-hole latrines.
- (5) Pail latrines.
- (6) Urine soakage pits.

## **78. Construction of Latrines**

The following general rules apply to the construction of all types of latrines:

*a.* To make sure that food and water will be protected from contamination, latrines should be built at least 100 yards from the unit mess and the nearest water source. Also, the latrine should not be dug below the water level in the ground nor in a place where it may drain into a water source.

Usually, latrines are built at least 30 yards from the end of the unit area but within a reasonable distance for easy access. At night, if the military situation permits, they should be lighted. If lights cannot be used, a piece of cord or tape may be fastened to trees or stakes to serve as a guide to the latrine.

*b.* A canvas or brush screen should be placed around each latrine, or the latrine may be enclosed within a tent. In cold climates this shelter should be heated. The screen or the tent should have a drainage ditch dug around its edges to prevent water from flowing over the ground into the latrine. For fly control, these shelters should be sprayed twice weekly with an approved insecticide.

*c.* On the outside of each latrine enclosure a simple hand-washing device should be installed. This device should always be kept filled with water and should be easy to operate.

*d.* Latrines should be policed every day. Certain unit personnel should be assigned the responsibility of ensuring that the latrines are being properly maintained.

*e.* When a latrine has been filled to within one foot of the surface, or when it is to be abandoned, it should be closed in the following manner: the contents of the pit, the side walls, and the ground surface to a distance of two feet from the side walls should be sprayed with a DDT residual solution or other insecticide. Then the pit should be filled to the ground surface with successive, 3-inch layers of earth. Each layer is packed down and its surface is sprayed with insecticide before the next layer is added. Then the latrine pit is mounded

over with at least one foot of dirt. The purpose of this method of closing is to prevent any immature fly that may hatch in the closed latrine from getting out. The location of the latrine should then be plainly indicated with a sign which is marked CLOSED LATRINE and is dated.

### 79. Straddle Trench Latrines

A straddle trench latrine is dug 1 foot wide,  $2\frac{1}{2}$  feet deep, and 4 feet long. This will accommodate two men at the same time. The number of trenches provided should be sufficient to serve at least 8 percent of the unit strength at one time. Thus, for a unit of 100 men, at least 16 feet of trench, or 4 straddle trench latrines, are needed (fig. 18). The trenches should be at least two feet apart. There are no seats in this type of latrine, but boards may

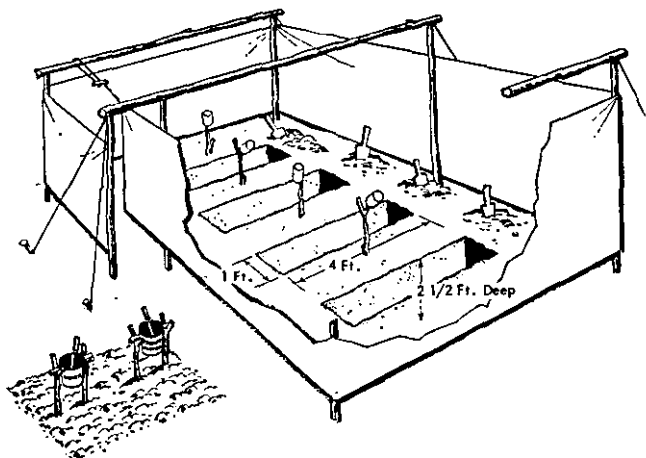

Figure 18. Straddle trench latrines for 100 men, with handwashing device.

be placed along both sides of the trench to provide better footing. Toilet paper should be placed on suitable holders and protected from bad weather by a tin can or other covering. The earth removed in digging is piled at the end of the trenches and a shovel or paddle is provided. This is done so that each man can promptly cover his excreta and toilet paper. When the unit leaves the area, or when the straddle trenches are filled to within one foot of the surface, the trenches should be closed in the manner described in paragraph 78e.

### 80. Deep Pit Latrines

The deep pit latrine is used with a latrine box. The standard type box provides four seats and is 8 feet long and  $2\frac{1}{2}$  feet wide at the base. A unit of 100 men requires 16 feet of latrine space, or two

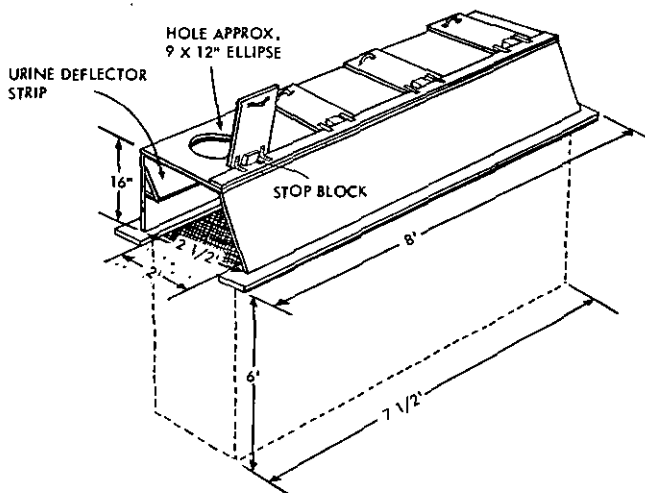

Figure 19. Deep pit latrine for 100 men.

latrine boxes (fig. 19). The holes should be covered with flyproof, self-closing lids. All cracks should be flyproofed with strips of wood or tin nailed over them. A metal deflector should be placed inside the front of the box to prevent urine from soaking into the wood.

a. The pit is dug 2 feet wide and  $7\frac{1}{2}$  feet long. This will give the latrine box 3 inches of support on all sides. The depth of the pit will depend on the estimated length of time the latrine is to be used. As a rough guide, a depth of one foot is allowed for each week of estimated use, plus one foot of depth for the dirt cover. Generally, it is not desirable to dig the pit more than six feet deep because of danger that the walls may cave in. Rock or high ground water levels often limit the depth of the pit. In some types of soil a support of planking or other material for the sides may be necessary to prevent wall cave-ins. Earth should be packed tightly around the bottom edges of the box so as to seal any openings through which flies might gain entrance.

b. In order to prevent flybreeding in the pit and to reduce odors, it is necessary to keep the latrine box clean, the seat lids closed, and the cracks sealed; also, a good fly control program must be maintained in the area. The use of lime in the pit, or the burning out of the pit contents, is not effective for fly or odor control and is not recommended. For fly control, the interior of the box and the contents of the pit should be sprayed twice weekly with a residual fly spray. The box and the seats of the latrine should be scrubbed daily with soap and water. When a unit leaves the area, or



when deep pit latrines are filled to within one foot of the ground surface, the latrines should be closed in the manner described in paragraph 78e.

### 81. Mound Latrine

This type of latrine may be used when a high ground water level, or a rock formation near the ground surface, prevents the digging of a deep pit. A dirt mound makes it possible to build a deep pit latrine and still not have the pit extending into the water or the rock (fig. 20).

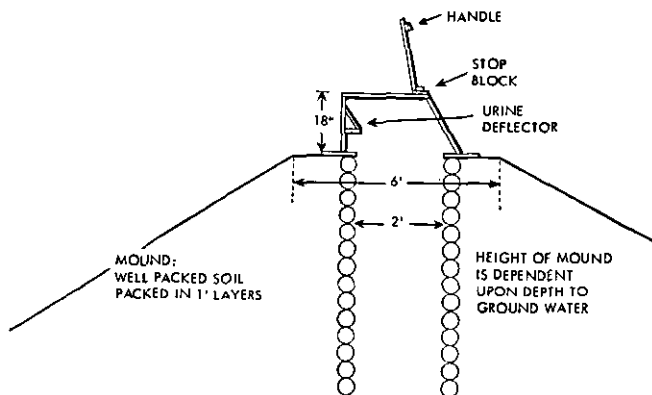

Figure 20. Mound latrine.

a. A mound of earth having a top at least 6 feet wide and 12 feet long should be constructed so that a 4-hole latrine box may be placed on its top. The mound should be high enough to meet the pit's requirement for depth, allowing one foot from the base of the pit to the water or the rock level. Before the mound is built, the area where it is to be placed should be broken up or plowed in order to

aid seepage of liquids from the pit. The mound is then built in 1-foot layers. The surface of each layer is roughened before the next is added. When the desired height has been reached, the pit is dug into the mound. It may be necessary to brace the walls with wood, sandbags, or other suitable material to prevent cave-ins. The size of the base of the mound will depend on the type of soil in the area and should be made larger if the slope is too steep. It may be necessary to build steps up the slope.

b. The mound latrine should be flyproofed in the same manner as is the deep pit latrine. It also

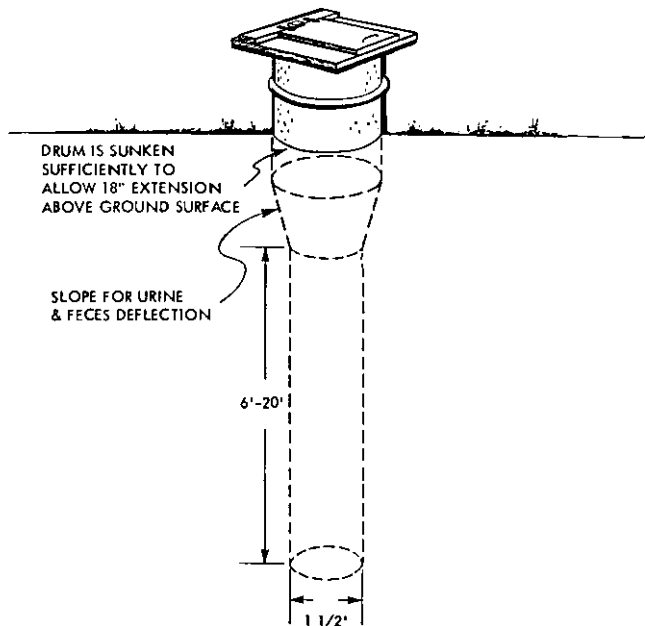

Figure 21. Bored-hole latrine.

is closed in the same manner as is the deep pit latrine.

## **82. Bored-Hole Latrine**

This type of latrine consists of a hole, about 18 inches in diameter and from 6 to 20 feet deep, covered by a one-hole latrine box (fig. 21). A converted metal drum may be sunk into the ground for use as a box. Both ends of the drum are removed and a flyproof seat cover, with a self-closing lid, is made to fit the top of the drum. This type of latrine is satisfactory for small units, provided the necessary mechanical equipment for boring the hole is available.

## **83. Pail Latrine**

A pail latrine may be built when conditions (populated areas, rocky soil, marshes) are such that a dug latrine cannot be used.

*a.* A standard type latrine box may be converted for use as a pail latrine by placing hinged doors on the rear of the box, adding a floor, and placing a pail under each seat. If the box is located in a building it should be placed against the outer wall so that the rear of the box opens directly to the outside of the building (fig. 22). The seats and rear doors should be selfclosing and the entire box made flyproof. The floor of the box should be made of an impervious material (concrete, if possible) and should slope enough toward the rear to facilitate rapid drainage of washing water. A urinal may also be installed in the latrine enclosure with a drainpipe leading to a pail outside. This pail also should be enclosed in a flyproof box.

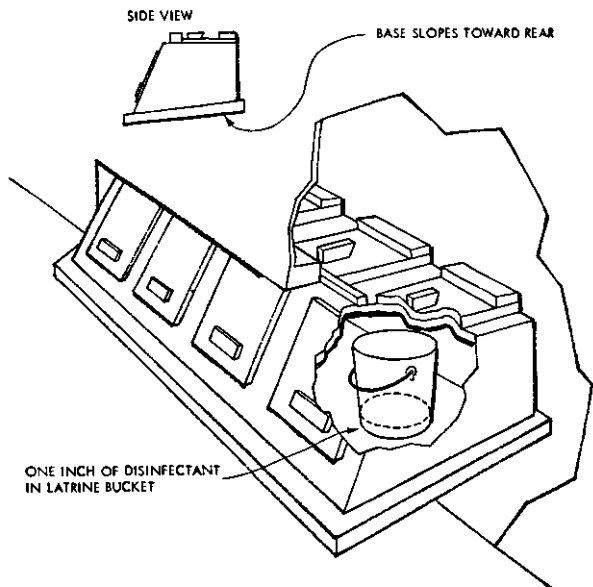

*Figure 22. Pail latrine in building.*

b. Pails should be cleaned at least once daily: oftener, if necessary. The contents may be buried, burned, or disposed of by other sanitary methods. After having been cleaned, when the pails are replaced they should contain one inch of Quarter-master disinfectant.

#### **84. Urine Disposal Facilities**

Urine disposal facilities should be provided for at least five percent of the command. This means that for a unit of 100 men, five pipe urinals are needed. When trough urinals are used, 10 feet of length should be allowed for every 100 men. In permanent and semipermanent camps, urine dis-

posal facilities are usually connected into the water-borne sewerage system.

a. When in the field, separate devices for the disposal of urine may be necessary. These should not drain into a pit latrine unless the soil is sufficiently porous to absorb the additional liquid. The best device for urine disposal in the field is the urine soakage pit. This pit is dug 4 feet square and 4 feet deep; it is then filled with rocks, flattened tin cans, broken bottles, or other coarse contact material. Depending on the materials available, either pipe urinals or a trough urinal may be used with this pit.

b. Pipe urinals should be at least one inch in diameter. They should be placed at each corner of

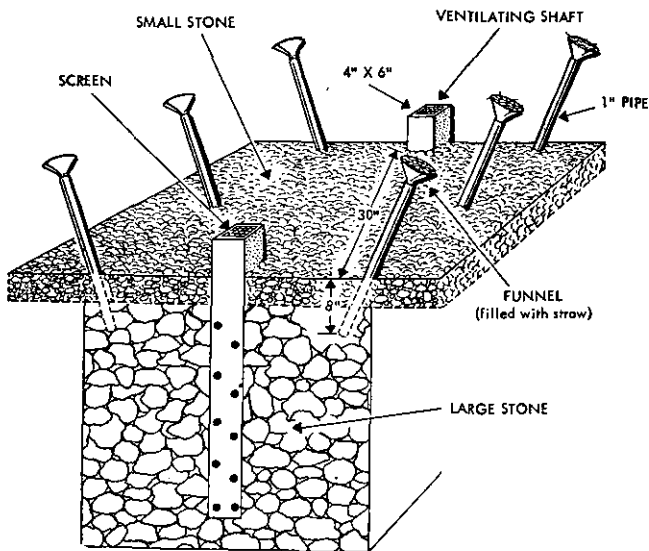
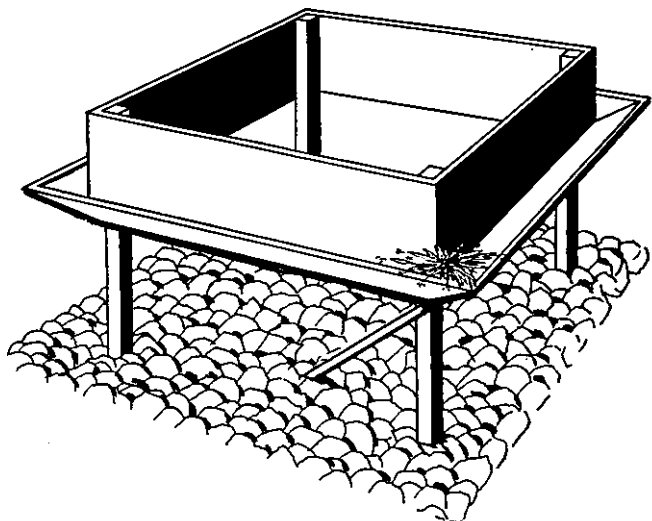

Figure 23. Pipe urinal arrangement.



*Figure 24. Trough urinal arrangement.*

the pit and, if needed, on the sides halfway between the corners (fig. 23). These pipes should extend at least 8 inches below the surface of the pit. A funnel of tar paper, sheet metal, or similar material is placed in the top of each pipe, the upper rim extending about 30 inches above the ground surface. These funnels are filled with grass or straw to keep out flies. The grass or straw filler should be changed daily.

c. If the necessary materials are available and more permanent facilities are desired, a trough urinal may be built. This trough may be either U- or V-shaped and made of sheet metal or of wood (fig. 24). If made of wood, the trough should be lined with heavy tar paper. The four sides of the

trough, each about six feet long, slope slightly toward one corner where a pipe is connected to carry the urine into the soakage pit. The trough end of the pipe should be filled with grass or straw which should be changed daily.

## 85. Operation

In order to ensure the proper operation of these latrine facilities the following procedures should be observed:

*a.* Use the trough or the pipes—do not urinate on the surface of the pit.

*b.* Change straw or grass daily and burn or bury the old material.

*c.* Wash funnels or trough daily with soap and water.

*d.* Replace funnels when necessary.

*e.* Do not let oil or grease get into the pit as this may cause the pit to become clogged and thus necessitate the digging of a new one.

*f.* If the latrine is located some distance from the sleeping area a large can or pail may be placed at a convenient location in the area for use as a urinal at night. The can used for this purpose must be emptied into the soakage pit every morning and washed with soap and water before being reused.

*g.* When a urine soakage pit is to be abandoned or has become clogged, it should be sprayed with a residual insecticide and mounded over with a 2-foot covering of compacted earth. Then the site should be marked with a sign labeled CLOSED SOAKAGE PIT.

### Section III. LIQUID WASTES

#### 86. Kitchen Wastes

Liquid wastes from mess operations contain particles of food, grease, and soap. Consequently, this liquid requires some kind of treatment before it is allowed to drain into a sewer or is disposed of by other means.

*a.* In permanent or semipermanent camps this waste, after first having passed through a grease trap, drains into the sewerage system. In temporary camps, however, this waste must be absorbed by the soil; and here, too, grease traps must be installed to take the grease from the liquid to prevent clogging of the soil and stopping absorption. These grease traps must be cleaned frequently and the removed grease either burned or buried.

*b.* In temporary camps a soakage pit, constructed like a urine soakage pit, normally will dispose of liquid kitchen wastes for a total of 200 men. The only difference in the construction of urine soakage pits and kitchen waste soakage pits is that in the kitchen waste soakage pit a grease trap is substituted for the pipes or troughs used in the urine soakage pit. If the camp is to last for several weeks, two kitchen waste soakage pits should be constructed, each pit to be used only on alternate days since a rest period will help to prevent clogging. A soakage pit that has become clogged should be abandoned and a new one constructed. When such a pit is to be closed it should be covered with two feet of compacted earth and the covered site marked with a sign labeled CLOSED SOAKAGE PIT.



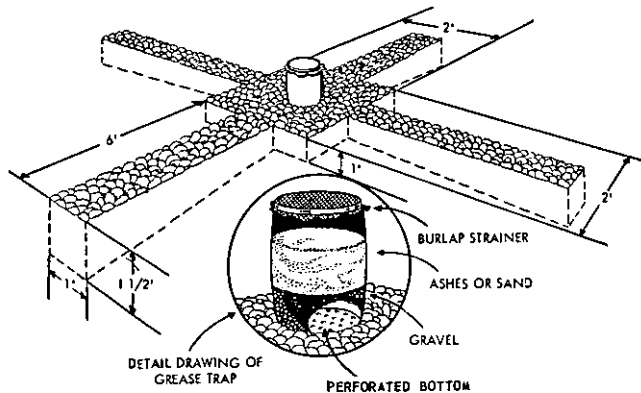

Figure 25. Soakage trench with pail filter grease trap.

c. If the ground water level or a rock formation exists close to the surface, a soakage trench may be used. This trench consists of a pit, 2 feet square and 1 foot deep, with a trench radiating outward from each of its corners for a distance of 6 feet or more (fig. 25). These trenches are built 1 foot wide and vary in depth from 1 foot at the central pit to 1 1/2 feet at the outer ends. The pit and trenches are filled with material similar to that used in the soakage pit. Two such units should be built for every 200 persons fed, each unit to be used on alternate days. A grease trap should also be used with a soakage trench.

## 87. Grease Traps

*Note* The grease trap should be of sufficient capacity so that the hot, greasy water being added will not heat the cool water already present in the trap. Otherwise, the grease will remain uncongealed and will pass through the trap.

a. A baffle grease trap may be made from half of a barrel which has been cut in two, or from a

box which has been divided vertically into unequal chambers by a wooden baffle (figs. 26 and 27). This baffle should extend to within one inch of the

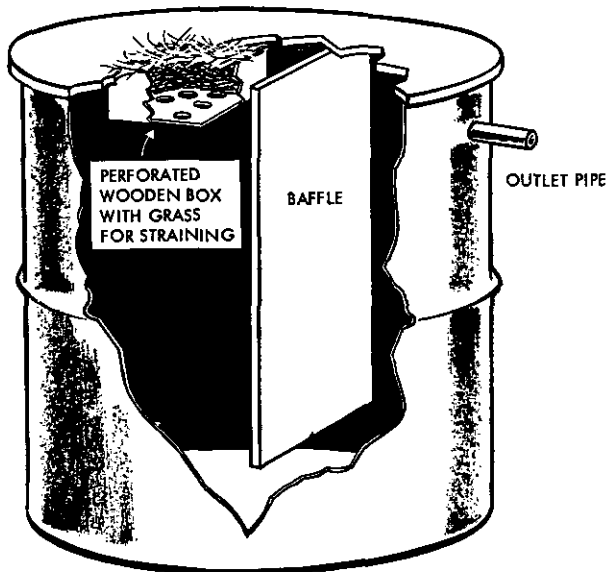

*Figure 26. Baffle grease trap (barrel type).*

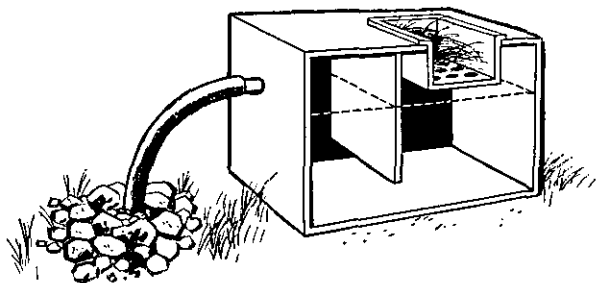

*Figure 27. Baffle grease trap (box type).*

bottom. The wastes are poured through a strainer into the larger chamber (about two-thirds of the capacity of the box or barrel); they then pass under the baffle and flow out of the smaller chamber. In the larger chamber the trap should have a removable lid and a removable strainer. The strainer, which may be a box with openings in the bottom, is filled with straw or burlap to remove coarser solids; it must be cleaned frequently to prevent clogging. A one-inch pipe, inserted about 6 inches below the top of the smaller chamber, acts as an outlet and carries the liquid from the trap to the soakage pit. To ensure proper operation of the trap it must be cleaned frequently. Grease must be removed, the trap drained, and the sediment in the bottom removed. The removable strainer may be cleaned by scrubbing it with soap and water. The grease, sediment, and straining material should be either burned or buried.

b. The barrel filter grease trap may be made from a 30-to 50-gallon barrel or drum which has had its top removed and a number of large holes bored into the bottom (fig. 28). Eight inches of gravel or small stones are placed in the bottom and covered with 12 to 18 inches of wood ashes or sand. A piece of burlap is fastened to the top of the barrel to serve as a coarse strainer. The trap may be placed directly over the soakage pit, or it may be placed on a platform with a trough leading to the pit. If it is placed directly over the pit, the bottom may be removed instead of having holes bored into it. Every two days the grease trap should be emptied, washed, and refilled with fresh ashes or sand. The old ashes or sand should be buried.

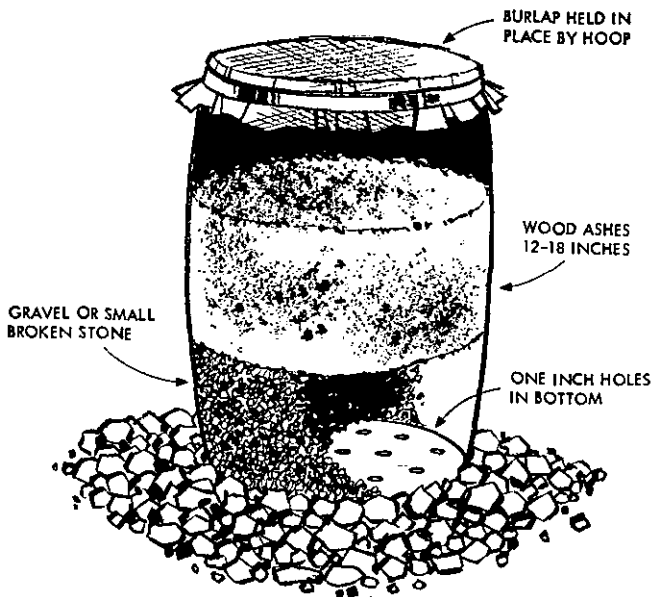

Figure 28. Barrel filter grease trap.

The burlap strainer should be either washed or renewed every day.

c. A pail strainer may be made by boring holes in the bottom of an old metal pail, or can, and filling it with grass or straw. This strainer will remove coarse particles of food and a small part of the grease. It may be used on top of the barrel grease trap to prevent the latter from becoming clogged by coarse food particles.

## 88. Bath and Wash Water

a. These wastes are disposed of in the same manner as are the liquid kitchen wastes. In perm-

anent or semipermanent camps they are usually drained into the water-borne sewerage system.

b. At field installations these wastes should pass through a grease trap which will remove the soap before they enter the soakage pit. Either the soakage pit or the soakage trench, each with a grease trap, may be used. In the field, every device that is used for washing or drinking should have some type of soakage trench under it. Figure 29 shows one method of connecting a washing rack to the soakage pit. The area under field showers should be excavated a few inches and then filled with small, smooth stones to keep the water from forming into pools under the shower device.

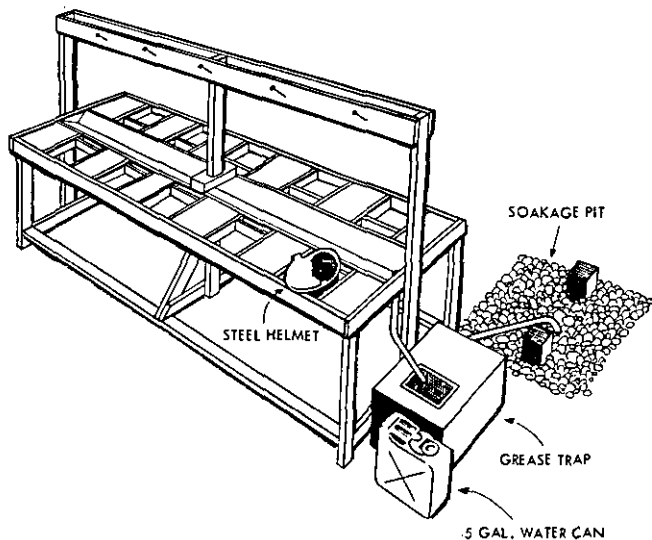

Figure 29. Washing device with soakage pit.

## Section IV. GARBAGE

### 89. General

Garbage is the solid or semisolid waste resulting from the preparation, cooking, and serving of food. It does not include rubbish, which is discussed in paragraphs 94 through 96. Garbage is classified as either edible or nonedible.

*a.* Edible garbage is that part of the garbage which is suitable for animal food. It includes scraps of meat, vegetables, and other material which may be eaten by hogs.

*b.* Nonedible garbage is that garbage which cannot be used for animal food. It includes coffee grounds, bones, egg shells, and the skins of citrus fruit. A kitchen usually produces an average of from one-half to one pound of garbage per man, per day. About half of this is edible garbage. Since garbage decays rapidly, causing odors and attracting flies and rodents, it should be collected at least once a day and hauled to a point of disposal.

### 90. Collection

*a.* The number of cans required for the storage of garbage at kitchens will depend upon the method of disposal. Few cans are needed when all of the garbage is buried or burned; more, when edible garbage is salvaged and sold. When kitchen wastes are salvaged, each type (edible garbage, nonedible garbage, grease, tin cans, glass, ashes) should be stored in separate cans on the garbage stand, each can being properly labeled.

*b.* Each dining hall should be supplied with a sufficient number of 32-gallon galvanized iron

garbage cans for the storage of kitchen wastes. These cans should have tight-fitting covers. To lessen the chance of spillage when they are removed from the garbage stand, cans should be filled no higher than four inches from the top. Cans should not be stacked on a vehicle; if they are, they may overturn or their covers may become bent. Except when removed for the purpose of being emptied or cleaned, cans should be kept on the garbage stand. They should not be kept in the kitchen.

c. At permanent or semipermanent installations, individual dining halls are generally equipped with can-washing facilities. These devices should have a concrete base. The floor should slope toward a center drain which should connect to the sanitary sewer. Under no circumstances should these wastes drain into the storm sewer. The washing section should be surrounded by a concrete curb to prevent the washwater from flowing onto the ground.

d. In all permanent and semipermanent camps a garbage stand is provided near each kitchen. This stand is usually constructed of concrete, with an 18-inch apron at the base. It may be from 12 inches to the level of a truck floor in height. A drain to a sanitary sewer from the platform makes cleaning easier. The platform should be scrubbed daily with hot, soapy water. In some camps the stand is made of wood, the boards being placed crosswise and spaced about three inches apart. This spacing allows any spillage to fall on the ground where it may be picked up and replaced in the can. This type of stand is less desirable than

the concrete stand and replacement should be recommended. A sign should be placed by each can, or group of cans, indicating the type of material that is to be placed therein, such as "edible garbage," "nonedible garbage," "refuse and tin cans," "ashes." These stands will not be screened as this would make their cleaning more difficult. Frequent treatment of the stand and the surrounding area with an approved insecticide will control flies that may be attracted to the area. Careful handling of the garbage is essential for fly, rodent, and odor control.

e. Since the spilling of garbage will pollute the soil and attract flies and rodents, garbage should never be transferred from one can to another at the stand. Provided that precautions are taken to prevent spillage, the garbage may be transferred to watertight truck bodies, properly protected from insects and rodents. Before being returned to the garbage stands the cans must be thoroughly cleaned. Garbage cans will not be painted or white-washed.

## 91. Sale or Gift

At permanent or semipermanent installations, edible garbage may be sold or given to civilians for use as animal food. The contract covering such sale or gift is made by the Quartermaster Corps and must conform to all military and local health department regulations. Before such a contract is awarded, an Army Medical Service officer should inspect the location where the garbage is to be used to make certain that it will not constitute a hazard to the health or welfare of the troops. The



person who receives the waste should provide a truck with a watertight body for the transfer of the garbage at the garbage stand. Emptied garbage cans are to be left at the stand for cleaning by the dining hall personnel. For the sake of maintaining sanitary conditions at the dining halls, persons collecting the garbage should make the collections at regular intervals and take every precaution to prevent spillage.

## 92. Burial

*a.* On the march, in bivouac, or in camps of less than one week's duration, garbage probably will be buried in pits. For this purpose, a pit 4 feet square and 4 feet deep is suitable for one day for a unit of 100 men. At the end of the day, or when filled to within about 1 foot of the surface, the pit should be filled in with earth and mounded over with an additional foot of compacted earth. Sometimes, a trench 2 feet wide and 4 feet deep may be used for the burial of garbage, the length of the trench depending on the length of time it is to be used. The operation of this trench is similar to that of the sanitary fill. The dirt that is removed to extend the trench is used to cover the garbage that has been added during the day.

*b.* A sanitary fill is a good method of disposal for all types of solid wastes and is used for this purpose at many permanent and semipermanent installations. Under this method the waste materials are placed in a continuous series of trenches, compacted, and then thoroughly sealed with a covering of two feet of earth. The earth used for covering is that which comes from the

digging of the next trench. As the sanitary fill requires close supervision and the use of heavy machinery, its use may not be practicable in small or in temporary camps. Details regarding the operation of a sanitary fill are published in TM 5-634.

### 93. Incinerators

a. Garbage and rubbish may be burned and reduced to an ash which may be used for fill; but the burial method is better and should be used whenever possible.

b. If burial is not practicable, several types of incinerators may be constructed for use in the field (Figs. 11 and 12).

c. The Corps of Engineers has standard incinerators of several types which are installed at certain permanent stations. These are specially designed high-temperature furnaces which can destroy garbage and rubbish without creating a nuisance.

## Section V. RUBBISH

### 94. General

a. Rubbish or trash consists of wastes which originate at kitchens, barracks, wards, quarters, and offices; it includes such items as emptied containers, waste paper, wood, metal, glass, ashes, and crockery. Depending on the local salvage program, some of these items may be salvaged and reused or sold.

b. Rubbish is divided into two classes: combustible—that which can be burned; and noncombustible—that which will not burn.

## **95. Permanent and Semipermanent Camps**

At permanent and semipermanent camps the collection of rubbish is the normal responsibility of the Corps of Engineers. Salvaged material may be collected separately and delivered to the salvage officer for disposal; or, if there is no local salvage program, both the rubbish and the garbage may be picked up together. Either incinerators or sanitary fills may be used for final disposal.

## **96. Temporary Camps and Bivouacs**

At temporary camps or on bivouac, rubbish usually is buried in pits or in trenches with the garbage. If this is done, care should be taken to flatten tin cans and break down boxes before they are added to the rubbish. Should the unit be located near an ocean or on an island, the rubbish and garbage may be disposed of by having it hauled out to sea and dumped.

## CHAPTER 6

# KITCHEN AND MESS SANITATION

---

### Section I. GENERAL

#### 97. Importance of Good Kitchen and Mess Sanitation

Food, even the most appetizing, can cause illness if through improper handling it has become contaminated with disease germs. Outbreak of food poisoning, dysentery, and typhoid fever may result from insanitary practices in kitchens and dining halls. Persons who handle food must always maintain the highest standards of personal hygiene and sanitation.

#### 98. Responsibilities

a. *Commanding Officer.* Commanding officers are responsible for the sanitary control of food served on military installations to members of their command as well as for the enforcement of sanitary regulations and orders which govern the handling and serving of food. The unit commander appoints a food service officer who has the duty of direct supervision over the messes within that unit.

b. *Quartermaster Corps.* The Quartermaster Corps procures, stores, and issues food, prepares master menus, trains food service personnel, and recommends measures for the proper preparation and serving of food.

c. *Army Medical Service.* The Army Medical

Service advises on the nutritional adequacy of the ration and is responsible for making sanitary inspections of the food and of food service facilities and operations.

## Section II. FOOD INSPECTION

### 99. General

All food used in the Army is inspected several times prior to its being issued to a unit. Specially trained medical service personnel, under the supervision of the Veterinary Corps, perform these inspections. If any signs of spoilage are noticed at the kitchen, the food must again be inspected and must pass the approval of a medical service officer before it may be prepared for serving. Locally produced foods will not be procured without prior approval of the surgeon.

### 100. Fresh and Cured Meat

Officers of the Veterinary Corps who have been trained in meat inspection approve meat before it is used as food; but kitchen personnel should also make a final check on the condition of the meat before it is prepared. The wholesomeness of meat may be determined by its color, odor, and consistency.

*a. Color.* The color of fresh meat depends upon the kind, the age, and the condition of the animal when killed, and the body part from which the meat is taken. Choice fresh beef usually is a bright cherry red; veal, a pinkish brown; mutton, a dark pink or red; lamb and pork, a light pink.

*b. Odor.* Meat should be free from any abnormal odor. An individual who is familiar with

the odors of different meats can detect spoilage in the deeper part of the meat by passing a clean knife deep into the center of the meat. The knife is then withdrawn and the odor of the knife is noted. If any abnormal odor is detected, it usually is evidence of spoilage.

*c. Consistency.* Good meat should feel firm to the touch and should barely moisten the fingers. If the meat has been affected only slightly on the surface, the inspector may consent to trimming or wiping off the surface of the cut. Slight surface spoilage and mold often may be removed by wiping with dilute vinegar or baking soda solution. If a considerable part of the cut is not firm or gives other evidence of questionable freshness, the meat should not be used.

## 101. Poultry

The term "poultry" includes chickens, ducks, geese, turkeys, and any bird or fowl used for food. Both poultry and meat products spoil readily if handled or stored improperly, but poultry is the more likely to be contaminated with disease-producing germs. Should poultry show any evidence of spoilage, slimy or sour carcass or other unsoundness, it should not be used as food.

## 102. Eggs

Disease germs may be transmitted by eggs which have become contaminated in the nest or through subsequent handling. All eggs, therefore, should be inspected for cleanliness, freshness, and soundness, and those found to be unsatisfactory should not be used for food. If a number of eggs are to be broken into one container, each egg

should be broken and dropped separately into a small dish before being added to the others in the larger vessel. In this way one spoiled egg will not ruin the entire lot. Since duck eggs are particularly prone to contamination without apparent change in color, odor, or appearance, they are not to be used by troops unless they have been thoroughly cooked.

### 103. Seafood

a. Because it spoils quickly, seafood must be handled transported, and stored with great care from the time it is taken out of the water until it reaches the dining table. To be sure that it is safe to eat, fresh chilled fish must be inspected carefully. The following are the most important signs of good quality in fish:

- (1) *Gills*. Bright red, usually closed, no abnormal odor.
- (2) *Eyes*. Prominent appearance, transparent cornea (window of the eye).
- (3) *Scales*. Tight.
- (4) *Skin*. Free from bad-smelling slime; not discolored.
- (5) *Flesh*. Firm; only temporary denting by finger pressure.
- (6) *Body*. Stiff, sinks in water; tail, fairly rigid.

b. Fish or seafood that is bruised, spoiled, or otherwise unsound is never to be used for human consumption. Oysters, particularly, spoil easily and must be inspected for bad odor and staleness; pink discoloration indicates that they are not fresh. Other seafood such as crabs, clams, shrimp,

and lobster also require careful inspection to ensure that they have a normal color and no unusual odor or appearance.

#### **104. Dairy Products**

*a.* Raw milk is an ideal culture medium (food) for bacteria and thus frequently contains disease germs. When the temperature of the milk is above 50°F., bacteria will grow and multiply rapidly. It is necessary, therefore, to observe the strictest sanitary control over the production, handling, and processing of milk. All milk used by the Army must be pasteurized and should be procured only from dairies approved by the Army Medical Service. The use of raw milk in Army kitchens and dining halls is forbidden.

*b.* Butter is the fat which is churned from cream. Like all other dairy products, butter must be safeguarded closely in every stage of its handling because it, too, can transmit disease to man.

*c.* Ice cream contains milk and butterfat. Since the process of freezing does not purify the ice cream it can spread disease to man if it becomes contaminated; it must therefore be safeguarded just like all other dairy products.

#### **105. Canned Foods**

*a.* All types of canned foods should be examined carefully for faulty containers. Spoilage of food within a can usually is indicated by some deformity or abnormality in the can itself. Normal cans have sunken ends. Defective cans are easy to detect and may be classified into the three types listed below. All three of these types should be



rejected unless they have passed inspection by qualified personnel of the Army Medical Service.

- (1) *Leaker*. This is a can that has a defect which allows air to enter the can or the contents to leak out. When air has entered a can the ends will no longer be curved in but will have flattened. The contents of such a can must be considered spoiled and must be discarded.
- (2) *Springer*. This is a sealed can which has one end bulging. Pressing on the bulging end with the thumb will cause the other end to bulge out or to "spring." This condition is due to gas-producing bacteria in the food which were not destroyed in the canning process or to bacteria which may have entered through tiny holes in the can.
- (3) *Sweller*. This is a can which bulges at the sides and ends. The causes are the same as those which produce the springer.

b. Cans that contain food must be protected from contamination by filth, flies, rats, and other vermin because such contamination may be transferred to the food when the can is opened and the contents are being removed. Canned food which has an abnormal odor, taste, or appearance must not be used without the approval of a veterinary or medical officer.

### Section III. HANDLING AND STORAGE OF FOOD

#### 106. General

Food must be protected from sun, heat, dust,

insects, rodents, and any other agent which might cause contamination or the growth of disease germs. Perishable foods, such as fresh vegetables, meats, dairy products, and bread should be issued daily, preferably in the morning.

#### **107. Transportation of Bread, Meat, and Similar Items**

*a. Cleanliness of Vehicles.* Vehicles used for transporting foods should be covered. They must at all times be kept clean and never be used for transporting garbage, trash, petroleum products, or other materials by which food might be contaminated.

*b. Means Used to Protect Food.* Every unit should secure clean tarpaulins, cloths, boxes, or bags for the protection of food from improper exposure, handling, or contact with contaminating objects. The officer who issues food supplies should report violations of these precautions to the commanding officer of the unit concerned.

*c. Refrigerated Vehicles for Bulk Shipment of Meat and Dairy Products.* Vehicles used for transporting bulk quantities of meat and dairy products over considerable distances should be refrigerated.

#### **108. Procedure to be Followed by Unit upon Receiving Food**

*a. Inspection.* Immediately upon its arrival, food received at the kitchen from the issuing point should be inspected by the unit mess officer or by another responsible individual. Food which appears unwholesome should be referred to a veterinary officer or to the surgeon for an opinion as to its suitability for human consumption.

*b. Immediate Storage.* Foods accepted by the kitchen should be placed in storage as quickly as possible. Staple items should be arranged neatly on storage racks. Vegetables, such as potatoes and onions, are best kept in bins constructed of slats so spaced as to permit the circulation of air. This will retard decay and spoilage.

### **109. Mechanical Refrigeration**

*a. Proper Storage of Items.* Food items under refrigeration should be spaced in such a manner as to permit cold air from the cooling unit to circulate to all parts of the stored food. When food has to be placed in containers, shallow trays are preferable because they permit rapid cooling of the items stored. All food items should be covered or protected in a manner that will prevent contamination of the food by drippings or by contact with unclean objects.

*b. Operating Temperature.* Frozen foods received in the kitchen must be stored in freezers or in the freezing compartments of the refrigerator at a temperature of 10° F., or lower. Unfrozen foods requiring refrigeration should be stored at a temperature no higher than 42° F.

*c. Efficiency of Cooling.* The cooling efficiency of refrigerators is increased by having the food stored properly and by regular defrosting. Variations in temperature should be held to a minimum. Leaving the refrigerator door open rapidly increases the temperature within the refrigerator.

### **110. Refrigeration Expedients**

Iceboxes or ice chests, when mechanical refrigeration is not available, should be used. Ice

for this purpose must be obtained from a source approved by the Army Medical Service. The drains for such boxes must not be connected directly to the sanitary sewers, as this could permit a backup of sewage into the box. As in mechanical refrigeration, the arrangement of food items in iceboxes should be such as will allow the free circulation of cold air. Usually it is impossible to maintain a temperature of 42° F. in iceboxes, but every effort should be made to bring the temperature down to at least 50° F. or lower.

### 111. Storage Rules for Various Foods

*a. Meat and Poultry.* As soon as received at the kitchen, all meats should be stored in the refrigerator. The procurement of fresh meat should be planned so that it will require no more than 72 hours storage. It is extremely important that refrigerated meat be hung so that air can circulate freely around it. Should frozen food accidentally become defrosted it should be used at once. No attempt should be made to refreeze it.

*b. Seafood.* Fresh fish and other seafood can be kept for several days if held at temperatures below freezing. Unless it is kept frozen, seafood should be used the same day it is issued to the unit. Variations in temperature should be avoided.

*c. Milk and Dairy Products.* As soon as milk is received, it should be stored in a refrigerator at a temperature below 42° F. Bottled milk is not to be submerged in ice water, as contaminated water may seep in through the cap. Fish, cheese, and certain vegetables such as fresh onions should not be stored near dairy products. Milk in open con-

tainers may absorb disagreeable odors and flavors from other foods. This is also true of butter. It should be stored at the lowest possible temperature and always in a tight container.

*d. Dressing.* Dressing for fowl should not be allowed to stand at room temperature. It should be prepared just before the fowl is to be cooked and handled as little as possible. After it has been cooked, and unless it is to be eaten within three or

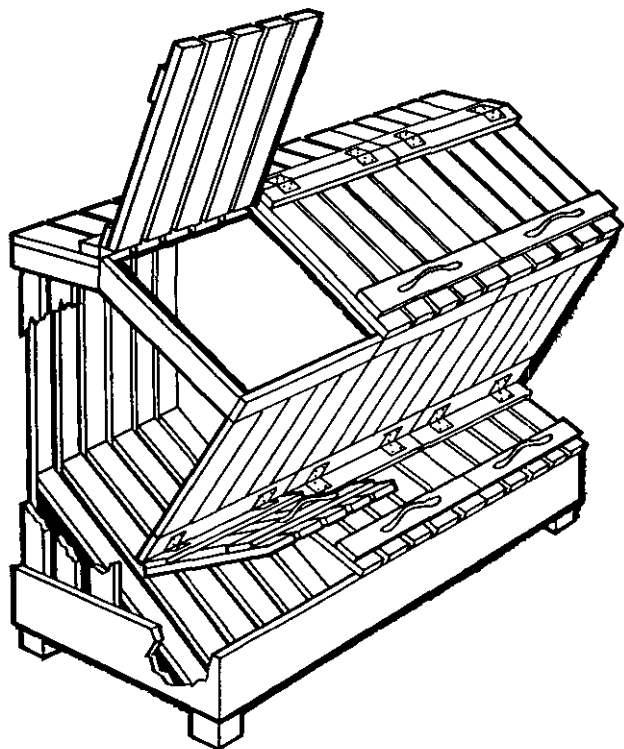

Figure 30. Vegetable bin.

four hours, the dressing should be removed from the roasted fowl and placed in a separate shallow pan for quicker chilling. Dressing is easily contaminated in preparation and is seldom thoroughly sterilized by the baking or roasting process. Since under these conditions germs can multiply rapidly, dressing may cause food poisoning if not held at a low temperature or eaten promptly.

*e. Bread.* Bread should be stored in screened cabinets to protect it from insects and rodents. Bread cabinets should not be placed close to the floor or ground where dust and dirt may be swept into them. Free circulation of air in the bread cabinet will delay the development of mold. If space is available, bread may be stored in the refrigerator.

*f. Vegetables.* Leafy, green vegetables must be stored in a refrigerator or other cool place. Such vegetables as potatoes and onions should be stored in dry, well-ventilated bins (fig. 30).

## Section IV. PREPARATION AND SERVING OF FOOD

### 112. General

While it is desirable to make food as attractive as possible, it is more important to assure sanitary methods of preparation, handling, and serving. A prime responsibility of food service supervisors and a most important element in the operation of a military mess is the training of food handlers to use sanitary methods in the handling of food. Failure to maintain high standards of personal cleanliness and health can quickly ruin a unit's food service program. Conveniently located, well-

kept handwashing facilities for all mess personnel are an absolute necessity in every Army kitchen. Washing the hands after going to the latrine must become a fixed habit continually to be enforced by supervisors.

### 113. Food Handlers

In the Army, food handlers are classified as permanent and temporary. Under certain conditions the employment of civilian food handlers is authorized.

*a. Permanent.* This class of food handlers includes cooks, bakers, permanent kitchen police, dietitians, and others assigned permanently to food-handling work. Prior to their assignment as permanent food handlers, personnel are given a preemployment physical examination by a medical officer. Those who have a communicable disease, or who are known to be carriers of such diseases, are not assigned as food handlers. Even more important than this initial screening is the supervisor's daily on-the-job check of food-handling personnel for signs of illness or infection. This inspection should be thorough enough to make certain that food handlers have no obvious signs of illness or infection; that their hands, fingernails, and clothing are clean; that they have no boils, rash, skin or wound infections. Food handlers should be instructed to report sore throats, colds, coughs, diarrhea, vomiting, or other symptoms of infection and disease. Questionable cases must be referred to the surgeon without delay.

*b. Temporary.* This class includes rotating

kitchen police. It usually is impossible to keep such transient personnel under sufficiently close and constant surveillance to be certain that they are free from infectious conditions. This class of food handlers, therefore, should not be assigned to duties which require them to come into contact with prepared foods .

*c. Use of Civilians as Food Handlers.* In parts of the world where sanitation is primitive and where intestinal and other communicable diseases are prevalent, natives should not be employed in Army kitchens to handle food without the specific approval of the surgeon. Where the employment of civilians as food handlers is approved, they should undergo the same type of preemployment examination as do Army personnel and they should be given the immunizations prescribed by the surgeon. Thorough instruction in sanitary methods and constant supervision over their work habits are even more necessary for such personnel than for military personnel.

#### **114. Raw Fruits and Vegetables**

*a.* Fruits and vegetables which are to be eaten raw must be washed thoroughly in potable water before serving. This applies especially to leafy and root vegetables such as lettuce, celery, cabbage, carrots, radishes, and fresh onions, all of which usually are contaminated with germs from the soil. In some areas of the world, human waste is used as a fertilizer. If it is necessary to use green produce grown in such areas, it must be washed and thoroughly disinfected before serving. Disinfection may be accomplished by dipping the



produce in boiling water for 10 seconds. Placing the fruits or vegetables in net bags will make dipping and draining them quick and easy. Since the boiling water must come in contact with all parts of the vegetables, the batches to be dipped should be small and loosely arranged. Leafy vegetables treated in this manner may show some wilting of the outer leaves, but when heat disinfection is used this cannot be avoided.

b. Chemical disinfection may be accomplished by trimming away the outer leaves, washing the produce thoroughly, and then immersing it for 30 minutes in a chemical solution prepared by dissolving one package of "Disinfectant, Chlorine, Food Service," in 10 gallons of warm water. A fresh solution must be prepared for each new batch to be treated. After the soaking, the chlorine may be removed from the produce by rinsing in potable water.

## 115. Milk

Milk is an excellent food. If obtained from an approved source and handled properly it can be used with safety. Three kinds of milk are used in the Army—pasteurized, evaporated, and powdered.

a. *Pasteurized.* Pasteurized milk is raw milk which has been heated to a temperature of 143° F. and held at that temperature for 30 minutes; or heated to a temperature of not less than 161° F. and held at that temperature for 15 seconds. This will destroy most of the common disease organisms found in milk.

b. *Evaporated.* Evaporated milk is pasteur-

ized milk from which half of the water content has been removed by evaporation. After the milk is sealed in the can it is sterilized by heat.

*c. Powdered.* Powdered milk is the solid portion of milk which remains after 99 percent of the water has been removed by heat and drying. Powdered *whole* milk contains the natural butter fat. Powdered *skim* milk contains no butter fat.

## 116. Preparation and Serving of Milk

*a.* Fresh milk for beverage purposes should be served in original 1-quart or smaller containers as received from the distributor, or from a bulk container through an approved dispenser. All unused milk left either in the opened original container or in an individual's drinking receptacle will be disposed of as food waste.

*b.* To prepare evaporated milk for drinking purposes, an equal amount of potable drinking water is added.

*c.* Powdered milk is made into liquid milk by dissolving it in drinking water. Whole milk powder stored for long periods of time may become rancid and for this reason is not included in all rations.

*d.* Reconstituted milk should be handled exactly like fresh milk.

## 117. Salads, Hash, and Chopped Meats

*a. Hazards.* Hash and chopped meats are foods ideal for the growth of bacteria. Salads containing egg, milk, or mayonnaise are also excellent culture media for germs. Since these foods require considerable handling in their prepara-

tion, the chances for contamination are greatly increased.

*b. Handling.* Whenever possible, the touching of food with the hands should be avoided. It is easy to learn to handle food with utensils (spoons, forks, tongs, or other suitable devices) and so avoid direct contact with the hands. Food service personnel who prepare salads should take special care to cleanse their hands with soap and hot water before they handle the ingredients. Foods which readily support bacterial growth, such as salad dressings, ham and chicken salads, hash, cream fillings, cream sauces, and custards, should be prepared as shortly before serving time as possible. Foods of this nature must not be held over from one meal to another or left standing at room temperature. Sandwich fillings for box lunches should never be made with spreads containing salad dressing, ground meat, or chopped egg. Preserved ground meats such as bologna, liver sausage, etc., may be used, but the modern quick-processed hams are apt to cause food poisoning since they readily support germ growth. Ham contaminated in preparation causes much of the food poisoning that occurs in the Army.

*c. Adequate Refrigeration.* At normal room temperatures the bacteria which cause food poisoning grow and multiply rapidly; as the temperature is reduced, their rate of multiplication is retarded. If it is necessary to prepare salads, sliced meats, and fowl as long as three hours before serving time they must promptly be cooled in shallow pans to a temperature of 42° F., or lower. Foods which readily support bacterial

growth should be kept under continuous refrigeration during the time elapsing between preparation and serving.

## 118. Temperature Guides

a. *Value of Thorough Cooking.* The best safeguards against getting sick from food are thorough cooking and immediate serving. With the exception of those foods which contain chemical poisons or the very common staphylococcus toxin, food usually can be made safe to eat by thorough cooking. It is necessary, however, that all parts of the food be heated close to boiling temperature.

b. *Minimum Times and Temperatures for Various Meats.* Food roasted or baked before eating should be heated so that the internal temperature of the meat is from 160° F. to 180° F. for at least one-half hour. A good rule to follow is to bake beef roasts 25 minutes for each pound of meat and pork roasts 30 minutes for each pound of meat at an oven temperature, in both instances, of 325° F. The longer cooking time for pork is necessary because of the danger of trichinosis which is caused by tiny parasitic worms. If meat juices and drippings are saved they should be refrigerated and then used as soon as possible.

c. *Use of Leftovers.* Meals should be planned so that there will be a minimum of leftover food. Foods of the type described in paragraph 117b should never be held over from one meal to the next. Other foods must be refrigerated immediately and not held over for more than 24 hours. The only exceptions to this policy are such

items as apples, bananas, and similar foods which do not require refrigeration and have not been subjected to contamination.

## Section V. CLEANING OF MESSES, KITCHEN EQUIPMENT, AND EATING AND COOKING UTENSILS

### 119. Importance

No one wants to eat in a dirty dining hall or from a dirty plate or mess kit. Particles of food that are allowed to remain on dishes or mess kits will become breeding places for disease-producing germs. This is the health reason for stressing the importance of thorough dishwashing.

### 120. Cleaning of Mess Halls and Their Furnishings

A dirty, unsightly dining hall usually is an indication of poor sanitation throughout the establishment. If personnel can be trained to keep the kitchen and dining room neat and clean, they can also be trained in the vital matter of sanitary food handling.

*a. Kitchen.* Floors, tables, stoves, and refrigerators must be kept clean. Covered cans should be placed at convenient places in the kitchen to collect wastes. If the kitchen is in a tent, the ground and surrounding area must be well policed.

*b. Storerooms.* Supplies should be stored above the floor on platforms about a foot high. These platforms can be made of scrap lumber. The area can be made insectproof and rodentproof by the use of the screening and metal strips

through which neither bugs nor animals can enter.

*c. Refrigerators.* Refrigerators must be cleaned frequently with soap and hot water or they will smell sour from spilled foods.

*d. Mess Tables.* Mess tables should have solid tops without cracks or crevices in which food particles can lodge. If material for solid tops cannot be found, tabletops can be made of smooth boards. When this is done the center board should be made removable for easier cleaning. Kitchen and dining tables should be scrubbed immediately after using. The presence of old food particles promotes the growth of germs and gives a sour, unpleasant odor to the establishment.

*e. Ranges.* Ranges should be cleaned after each meal; otherwise dirt and grease will accumulate and be baked onto the metal.

## **121. Cleaning of Cooking Utensils**

Cooking utensils must be cleaned and disinfected after each use. They should be scraped free of food particles, washed in hot soapy water, rinsed in hot water, and rinsed again in boiling water; then allowed to dry in the air. Cooking utensils should be stored in a clean, covered place where they are protected from dust and vermin.

## **122. Unit Cleaning of Eating and Serving Utensils**

When all of the eating and serving utensils of a unit are collected for washing, the following methods may be used:

*a. If Hot Water is Available.*

(1) Wash in warm water containing soap or

other detergent.

- (2) Rinse in clear, hot water.
- (3) Give a final, disinfecting rinse in clear water at 180° F. for 30 seconds (when a thermometer is available to check temperature) or immerse in boiling water.
- (4) Dry utensils in the open air.

*b. If Hot Water is Not Available.*

- (1) Wash the utensils in water containing soap or detergent.
- (2) Rinse in clear water.
- (3) Immerse for not less than 30 seconds in a solution of "Disinfectant, Chlorine, Food Service." This solution is prepared by following the direction on the package. When this material is not available, immerse for not less than 30 seconds in a chlorine solution containing at least one level mess kit spoonful of high test calcium hypochlorite (water sterilizing powder) in 10 gallons of water. These quantities of disinfectant will ordinarily suffice for disinfecting the personal mess gear of approximately 100 men.
- (4) Dry in the open air.

### 123. Individual Cleaning of Mess Gear

*a. Equipment.* In the field, each individual cares for his own mess gear. Proper washing is important, otherwise food particles will remain and become breeding places for disease germs. Three GI cans or other similar containers, placed in a row, are used for this purpose. Enough water

is placed in each can to allow at least one quart of water per man. Large messes may require several washing lines. The first GI can contains hot, soapy water (120° F. to 140° F.), the second and third cans contain clear water which is kept boiling throughout the washing period. A long-handled washbrush and a garbage can or pit are also needed.

*b. Procedure.*

- (1) Scrape the food scraps remaining in the mess gear into the garbage pit or the garbage can.
- (2) Wash the gear in the first container of hot, soapy water using a long-handled brush.
- (3) Rinse the gear in the second can of clear, boiling water by dipping it up and down several times.
- (4) Disinfect the gear by putting it in the third container of boiling water for several seconds.
- (5) Remove the gear and shake it to remove the excess water. Allow it to dry in the air. Replace cover to keep out dust and vermin.

*c. Methods of Heating Water.*

- (1) *Immersion heater.* This unit is the field-type water heater used most widely in the Army. It is standard equipment for all units organized under tables of organization and equipment. The heater is fired by gasoline and consists of a doughnut-shaped combustion chamber and a stack assembly welded together. The



unit is placed directly in the water that is to be heated and displaces approximately 12 gallons of water. A metal plate with operating instructions is located on the hinged hood which covers the top of the burner compartment.

**Caution:** Do not operate heater within a building, tent, or other enclosed place unless exhaust fumes are piped outside.

For more detailed information on operation and maintenance, see TM 10-702.

- (2) The heating unit of the Quartermaster field range, M-1937, can be used to heat water for cooking and cleaning purposes.
- (3) When standard items either are not available or are insufficient in number to heat water properly, necessary devices must be improvised. Chapter 4 describes several excellent methods of heating water in the field.

*d. Disinfection Prior to Use.* Mess gear should be cleaned and sterilized before use by immersion in boiling water. In addition to killing any bacteria present and removing dust, the boiling water heats the mess kit and helps to keep the food warm.

# CHAPTER 7

## PERSONAL HYGIENE

---

### Section I. GENERAL

#### 124. Definition

Personal hygiene is the practice of health rules by the individual to safeguard his own health and the health of others. Personal hygiene is often thought of as being the same as personal cleanliness. Yet, while cleanliness of the body is important, it is but one of the many essentials of healthful living.

#### 125. Importance of Personal Hygiene

Personal hygiene contributes to health in several ways—

a. It protects the individual against disease germs that are present in the environment.

b. It protects the group by reducing the spread of disease germs.

c. It promotes positive or total health—a state of maximum physical and mental well-being above and beyond the mere absence of disease.

d. It improves morale.

#### 126. Responsibility

a. *The Individual.* A soldier's fulfillment of the obligation of honorable military service involves doing the best job possible in any given assignment. This demands, among other things,

that the soldier maintain his health and physical fitness at the highest level; also, that he do everything possible to protect and promote the health of the other members of his organization. This calls for a clear understanding and continuous application of the principles of personal hygiene.

*b. Commanding Officer.* The unit commander is responsible for:

- (1) Providing and maintaining facilities, equipment, and supplies necessary for the personal hygiene of his command.
- (2) Ensuring that the members of his command are instructed in the essentials of personal hygiene.
- (3) Securing compliance with the principles of personal hygiene. He must obtain the cooperation of each individual in maintaining good health and physical fitness for the job.

*c. Medical Officer.* The unit surgeon is the technical advisor on hygiene and sanitation. As such, he or his assistants—

- (1) Conduct instruction in personal hygiene.
- (2) Carry out inspections and observations of personnel and facilities.
- (3) Recommend correction of such defects as have been found.

## **127. Importance of Prompt Medical Treatment**

The Army provides for its members a medical service of the highest possible caliber. Seeking medical care without delay may avert or at least shorten illness, hasten recovery, and prevent the spread of disease to others. Resorting to self-

treatment or to treatment from unauthorized sources outside of Army channels may prove dangerous.

### **128. Importance of Individual Health to Unit Efficiency**

An efficient military unit is a carefully planned, well-organized, well-trained fighting team. It is a team that carries no substitutes. When any team member is absent or sick, teamwork suffers. Carelessness of one member of an organization on matters of health may result in incapacitating the personnel of an entire unit.

## **Section II. MEASURES TO PROTECT AND IMPROVE HEALTH**

### **129. The Principles of Personal Hygiene**

Paragraphs 130 through 141 discuss in detail the measures which the individual may apply personally to prevent disease and to promote health and physical fitness. Collectively, these are the rules or principals of personal hygiene. These principles will be considered under the following headings:

- a.* Personal cleanliness.
- b.* Care of the mouth and teeth.
- c.* Care of the feet.
- d.* Food and drink.
- e.* Exercise.
- f.* Rest and recreation.
- g.* Protection against the elements.
- h.* Protection against insects.
- i.* Avoidance of the sources of disease.
- j.* Cultivation of a healthy mind.

## 130. Personal Cleanliness

a. *General.* Even before it was known how the germs of disease are spread, civilized people gave attention to personal cleanliness because of a desire to please themselves as well as to be attractive to others. Now it is known that there are also sound medical reasons for bodily cleanliness. Dirt, filth, and invisible disease agents (germs) are inseparable. Keeping the body and clothing clean is a simple, effective means of reducing the number of disease agents which could invade the body.

b. *The Skin.* The body should be washed from head to foot frequently with soap and water. If no shower or tub is available, the body should be cleaned with a wet, soapy cloth, paying particular attention to the body creases (armpits, groin, crotch), the face, hands, feet and under the foreskin. Infections, cuts, and burns should have prompt treatment at the dispensary. Some of the more common and troublesome diseases of the skin are considered in subsequent chapters of this manual.

c. *The Hair.* The hair should be kept neatly trimmed—preferably two inches or less in length—and combed. At least once a week the hair and scalp should be shampooed with soap and water. The soldier should be clean shaven. Combs, brushes, and razors are not to be shared with other persons.

d. *Hands.* Fingernails should be kept closely trimmed and clean. The hands should be washed (with soap and warm water, if available) after

any dirty work, after each visit to the toilet, and before touching food or food utensils. The habits of nose-picking, nail-biting, and unnecessary scratching will cause contamination of the hands and of the things later touched by the hands. These habits are unpleasant to see, are unhealthy for the individual, and should be controlled. Coughs and sneezes should always be smothered in a tissue or handkerchief or at least should be directed away from other persons. Fingers and other contaminated objects should be kept out of the mouth.

*e. Clothing.* Clothing easily becomes contaminated with any disease agent that may be present in the stool, urine, or in secretions of the nose and throat. Underclothing, if possible, should be changed daily. Outer clothing should be washed or cleaned when it has become soiled. Shaking of clothing, followed by a 2-hour airing and sunning, will greatly reduce the content of disease germs. The shaking should always be done out of doors. At least once a week bedsheets should be changed, and blankets, pillows, and mattresses should be sunned and aired.

### **131. Care of the Mouth and Teeth**

The mechanical cleansing of the mouth and teeth by means of toothbrush, dentifrice, dental floss, and toothpick constitutes the fundamental principle of good oral hygiene. Ideally, this cleansing should be done immediately after eating and just before retiring. In the absence of prepared dentifrices, soap or table salt and soda with water will do an excellent job of removing food

particles lodged between the teeth. Both the inside and outside surfaces of the teeth should be brushed in a direction away from the gum tissues and toward the biting surfaces. Cross-brushing of these surfaces can be harmful to tooth structures and should be avoided. The chewing surfaces of the teeth are best cleansed by vigorous horizontal strokes combined with a twisting motion. Mouth brushing, to include the gum tissues, roof of the mouth, and tongue, is equally as important as brushing of the teeth and can be performed safely with lightly placed strokes of the brush. Dental floss and toothpicks are considered excellent supplements to the toothbrush. Prepared dental floss with flat surfaces and a coating of wax permits entry between tooth surfaces without injury to soft tissues. A flat, polished toothpick can be used effectively and safely if forceful entry between surfaces is avoided.

a. *Care of Dentures and Bridges.* It must be recognized that replacements for lost natural teeth in the form of dental prosthetic appliances are only substitutes. The degree of successful usage that can be expected of these replacements is in direct proportion to the care and maintenance given them by the wearer and the dental officer. Cleansing of removable and fixed dental appliances is of greatest importance and should be given as much care as is given to the cleansing of natural teeth. In no instance should it be assumed that the prosthesis is equal or superior to natural teeth. Distorted or damaged dentures can be injurious to mouth tissues and should be evaluated and adjusted by a dental officer.

*b. Tooth Restorations.* Fillings, crowns, inlays, and other types of restorations are simply substitutes for lost tooth structure and have varying degrees of functional limitations. The use of good judgement regarding these limitations will be the determining factor in the overall functional effectiveness of the teeth and the health of all of the oral structures. Damaged or loose restorations should be replaced early. Teeth and other oral structures which appear or feel abnormal should be examined by a dental officer with the least possible delay.

### 132. Care of the Feet

Battles and wars still are being won by the foot soldier. Proper care of the feet is essential to the maintenance of physical fitness. Serious foot trouble usually can be prevented by observance of the following simple rules of foot hygiene.

*a. Proper Fitting of Shoes.* In the field, only footgear issued by the Quartermaster Corps should be worn. Expert fitting at the time of issue is absolutely essential. There should be no binding or pressure spots; neither should the footgear be so large that it will permit the foot to slide forward and backward when walking.

*b. Socks.* Socks should be changed and washed daily. They should be large enough to allow the toes to move freely, but not so loose as to wrinkle. To allow for shrinkage, woolen socks should be at least one size larger than cotton socks. Socks with holes or poorly darned socks will cause blisters. Different types of socks are provided for



special footgear. The proper use of the various types should be learned at the time they are issued.

*c. Common Foot Troubles.* Blisters, corns, bunions, ingrown toenails, and fungus infections are the most common causes of foot trouble. Blisters can be prevented by the proper fitting and slow breaking-in of shoes and the wearing of properly fitting, whole, clean, dry socks. If a blister develops, treat it as follows:

- (1) Wash the foot and dry thoroughly.
- (2) Insert a flamed needle, pin, or fine knife-point into the lower edge of the blister to let out the fluid.
- (3) Apply adhesive tape or plaster bandage. Corns and bunions usually can be prevented or relieved by the wearing of properly fitted shoes. Ingrown toenails develop when nails are improperly cut. Toenails should be trimmed square across rather than on a curve. If tenderness develops in the nailbed or along the edge of the nail, report to the dispensary.

*d. Prevention of Fungus Infection.* Fungus infection (dermatophytosis, athlete's foot) is the most common infection of the feet and the most common of skin diseases. Serious trouble with athlete's foot can almost always be prevented by careful attention to good foot hygiene as described in paragraph 237.

*e. Special Care of the Feet on Foot Marches.* The foot march is the severest test of fitness of the feet. Unless special attention is given to the feet of marching troops, serious casualties from foot troubles will result.

- (1) *Preparation for the march.* Well in advance of the march, unit officers should ascertain by means of inspection that all men are equipped with the proper type of well-fitting, broken-in footgear; with the necessary number of clean socks free of holes or bunchy darns; and with an adequate supply of foot powder. Any deficiencies in supply or proper fitting should be corrected before the march is begun. Blisters, pressure spots, and infections should be treated promptly. Sound, well broken-in footgear should be selected. Never attempt to "break in" a new pair of shoes or boots on a long march.
- (2) *On the march.* The feet should be kept as dry as possible. If socks become damp from perspiration or wetting they should be changed for dry ones at the first opportunity. Placing damp socks under the shirt around the waist will do a good job of drying if the body is not sweating. Tender pressure spots should be relieved promptly by adjusting gear or applying adhesive tape. Once or twice daily during the march the feet should be dusted lightly with foot powder.
- (3) *At rest periods.* The feet should be inspected from time to time and preventive measures applied before serious trouble develops. Persistent complaints should be brought to the attention of the aid man or other medical personnel. If pos-

sible, the feet should be washed during the noon break. While resting, it is helpful to elevate the feet: this reduces congestion and swelling. Company officers should make periodic checks for foot complaints and see to it that corrective measures are applied.

- (4) *In bivouac.* All used socks should be washed thoroughly with soap and water, stretched to facilitate drying, and hung in the sun or in an air current. Woolen socks should be washed in warm water but never boiled.

### 133. Food and Drink

For proper development, strength, and survival, the human body requires the following variety of food substances: proteins for developing muscle, fats and carbohydrates for energy, minerals for blood and bone, certain essential vitamins, and water. The Army ration provides these essential food elements in adequate amounts and in proper balance and is varied to meet the special requirements of climate and activity. A normal, healthy appetite usually will ensure the intake of adequate amounts of all essential elements. Only occasionally is it necessary to provide supplements, such as salt for hot climates or vitamin tablets for special nutritional situations. Our common beverages (soft drinks, tea, and coffee) contribute little to the diet nutritionally, but they do no harm if taken in moderation. Alcohol, if taken in more than small quantities, impairs judgment and slows the reflexes, contributes to overweight, and is habit

forming. The beverages of health are milk, fruit juices, and water.

#### **134. Exercise**

Regular exercising of muscles and joints is necessary for maintaining physical stamina and good health. Military duties usually impose a considerable amount and variety of physical activity. Training schedules include periods of supervised physical training. But when such physical training is not included in the soldier's schedule, he should participate voluntarily in some form of exercise or sports to develop and maintain his physical fitness. Both the supervised and voluntary exercises should be suited to the age and physical condition of the individual and should stop short of causing extreme fatigue and exhaustion.

#### **135. Rest and Recreation**

Our bodies require regular periods of rest to restore physical and mental vigor. Seven or eight hours of unbroken sleep each night is desirable. The soldier, however, must learn to make himself comfortable and to obtain rest under conditions less than ideal. He must learn to use the shelter half, the blanket, and the sleeping bag as substitutes for the barracks and the bed. In the course of his daily schedule he should use his rest periods to obtain a change either from physical exertion to complete rest, or from mental activity to physical activity, as the case may be. Part of his off-duty time should be devoted to pleasant recreational activities such as social and religious activities, avocations, hobbies, and sports.

### **136. Protection Against the Elements**

Both in training and in combat the soldier is often exposed to the full force of the elements; to extremes of heat, cold, rain, mud, and wind, in situations which make it impossible for him to give the normal thought and care to his comfort. For his protection against these forces of nature, he is provided with the best equipment available. If he is to survive the hardships of training and combat, he must learn to use and to adjust himself to this equipment. Among the important adverse effects of the elements are frostbite, trench foot, heat exhaustion, heat stroke, and sunburn. These conditions and their prevention are described in detail in chapter 16.

### **137. Protection Against Disease-Bearing Insects**

Cleanliness of the body and clothing is the first line of defense against body parasites. In certain situations special measures must be used to control body lice, mosquitoes, fleas, and other insects. These measures are considered in detail in subsequent chapters.

### **138. Avoidance of the Source of Disease**

Through the application of a variety of measures, the Army attempts to make the soldier's surroundings as healthful as possible. This includes the provision of water and food free from disease germs and poisons and of facilities for the sanitary disposal of body wastes and the elimination of insects and rodents. Certain special procedures such as drug prophylaxis, immunization, and the detection and treatment of cases of

communicable disease are additional measures which can be applied with a minimum of individual effort. Ultimately, however, the health of an organization depends on the consistent, intelligent application of the rules of healthful living by each and every member of that organization. The soldier must avoid food and drink which may possibly be contaminated; he must protect himself against insects; and he must not expose himself unnecessarily to the germs of venereal disease, dysentery, malaria, and a host of other infectious diseases. Particularly must he avoid close association with natives in areas where sanitation and hygiene are still in a primitive state.

### **139. Special Protective Measures**

Each different geographical area, climate, and living situation has its own special health hazards. As the occasion arises, military personnel are given necessary instruction in the nature of these dangers and in ways of guarding against them. Among the special measures for individual protection are the use of bednets, the wearing of proper clothing, protection against frostbite, the use of prophylactic measures, the addition of salt to the diet, and the use of individual water purification tablets. The degree of effectiveness of these and other protective measures depends on their consistent and intelligent use by every individual of the organization.

### **140. Cultivating a Healthy Mind**

The health of the body is bound up with the health of the mind. Mental disorders may be just

as disabling as are physical diseases. The soldier who is incapacitated by combat fatigue is just as much a casualty as is the soldier with malaria. In considering the total health of the individual, both his mental and his physical health must be considered. A sense of well-being, the absence of overpowering fears and anxieties, and a wholesome attitude toward life are the essentials of total health. By following the suggestions given below, much can be done to cultivate and improve this aspect of health and prevent the occurrence of mental disorders.

*a. Friendliness.* The individual should seek friendships among the members of his organization, learn to enjoy the companionship of others, and join wholeheartedly in group activities. By active participation in group activities morbid concentration on personal and individual problems and feelings will be avoided.

*b. Tolerance.* Apply the Golden Rule. The Army is composed of individuals of various ages, races, and religious beliefs. The right of each individual to his own beliefs and habits should be respected.

*c. Combatting Worry.* Worry has been defined as a lot of useless thoughts whirling around a hub of indecision. While worry cannot be shut off like a faucet, positive action can be taken to combat it. Troubles should be faced boldly; they may be put into words and shared with one's associates. Unit officers, chaplains, and medical officers are interested in the physical and mental welfare of each person in their unit and should be

consulted by those whose worries threaten to get them down.

*d. Combatting Fear.* Fear is a normal reaction. It serves the important purpose of preparing the body for action, for selfdefense. Fear is only destructive when allowed to get out of control. The best defense against overpowering fear is familiarity with the sensations involved—the trembling, the jumpiness, the pounding heart, the sick stomach, the sweating, the momentary “freezing.” That is why the soldier is given battle indoctrination—to familiarize him with the sounds and the sights that cause fear in combat and to learn to control the normal fear responses to them. The best antidote for fear is action. The individual should concentrate on the job to be done and act in accordance with his orders and training. By doing so he will find that fear loses its paralyzing powers.

#### **141. Rules for Avoiding Illness in the Field**

Under field conditions the dangers of disease are multiplied. Following are some simple “do’s” and “don’ts” that will help to keep the soldier healthy.

*a.* Don’t consume foods and beverages from unauthorized, unapproved sources. They are very apt to contain disease germs or poisons. When away from approved water sources, use water purification tablets as instructed, or boil water that is to be used for drinking.

*b.* Don’t soil the ground with urine or feces. Use the latrine. In the field, dig a “cat hole” and cover your waste.



c. Keep the fingers and other contaminated objects out of the mouth. Wash hands following any contamination and before eating or preparing food.

d. Be sure that after each meal the mess kit, knife, fork, and spoon are well cleansed and sterilized in boiling water or in a germicidal solution. Whenever possible, resterilize them just before use.

e. Avoid the bites of insects by keeping your body clean, wearing proper, protective clothing, and using bednets, insecticides, and repellents, as instructed.

f. Avoid unnecessary wetting and chilling. When wet, change to dry clothing at the first opportunity. When possible, wear clothing suited to the temperature, weather conditions, and type of activity.

g. Don't share with others such personal items as canteens, pipes, mouth organs, towels, toothbrushes, handkerchiefs, and shaving outfits.

h. Don't take a laxative for pain in the stomach. Instead, see a medical officer.

i. Don't throw food scraps, cans, and refuse about the camp area. Such accumulations serve as breeding places for disease-carrying insects and rodents.

j. Avoid contacts with sources of disease. This applies particularly to natives in areas where sanitation is poor.

k. Don't contact loose women. Prostitutes and promiscuous women inevitably become infested with venereal disease. There is no such thing as a "clean" prostitute. Venereal disease may develop

in spite of all the protective measures taken after exposure.

*l.* Whenever possible, get seven or eight hours of sleep each night.

*m.* Engage regularly in some form of physical exercise or sport, preferably out of doors.

*n.* Use a portion of off-duty time for wholesome recreation and self-improvement: sports, hobbies, studies, religious activities.

# CHAPTER 8

## MOSQUITO-BORNE DISEASES AND THEIR CONTROL

---

### Section I. GENERAL

#### 142. General

Mosquitoes are found all over the world. In the tropics and subtropics they breed throughout the year; and even in the subarctic regions they appear in tremendous numbers during the brief summer season. Most of the disease-vector (disease-carrying) mosquitoes are found in the milder climates and in the tropics. Since different types of mosquitoes transmit different types of diseases, it is important to know the type, the habits, and the characteristics of mosquitoes in each area. For this reason considerable space is given in the following paragraphs to the characteristics of mosquitoes and to the means and methods of their control. Figure 31 presents a schematic view of the important parts of the mosquito body.

#### 143. Diseases

Diseases transmitted by mosquitoes include malaria, dengue, yellow fever, virus encephalitis, and filariasis. Of these, malaria is the greatest threat to military operations. It is important to realize that antimosquito measures are the major weapons against this group of diseases. In addi-

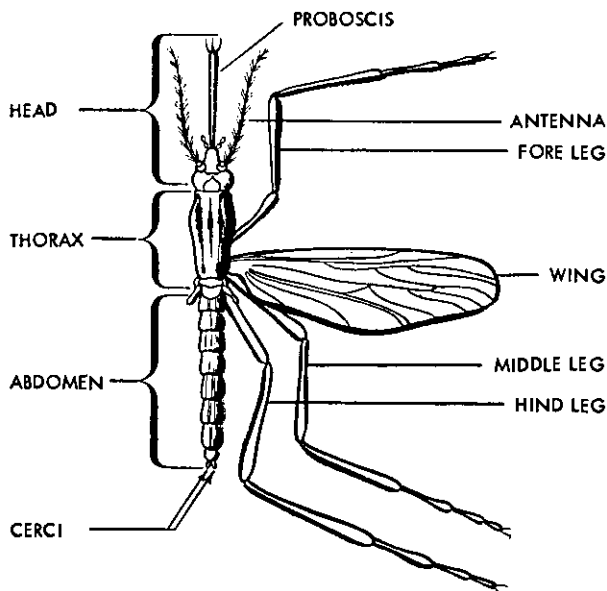

Figure 31. Adult mosquito.

tion, there are excellent drugs for the suppression and cure of malaria and an excellent vaccine for the prevention of yellow fever.

*a. Malaria.* Malaria is one of the most common and disabling of diseases found in tropical and subtropical countries. It is caused by a microscopic parasite carried by the female of the *Anopheles* mosquito. This parasite destroys the blood cells and causes chills, fever, weakness, and anemia. Unless the disease is treated promptly and properly, it may cause death by damage to the brain or rupture of internal organs. The only sure way of preventing malaria is to avoid the bites of infected mosquitoes. In areas where com-

plete control is difficult or even impossible, the so-called "suppressive" treatment often is used. This consists of taking, regularly, small doses of a drug such as chloroquine. These drugs do not absolutely prevent malaria, but they do hold down the symptoms, so that the infected person can carry on his duties. When the drug is stopped the symptoms may reappear, usually within a month, but sometimes after a much longer interval. Individuals who are trained in "malaria discipline" can avoid becoming infected with malaria. This phase of prevention is most important in the malaria prevention and control program.

b. *Dengue (Breakbone Fever)*. This is an acute type of painful fever caused by a virus which is spread from person to person by an *Aedes* mosquito. It seldom is fatal, but it causes severe aches and pains in the joints and bones. The best preventive for dengue is the prevention of bites from infected mosquitoes.

c. *Yellow Fever*. This is a highly fatal disease caused by a virus which is usually transmitted to man by an *Aedes* mosquito. In the jungles of Central and South America it is transmitted to man by the *Haemagogus* mosquito. Fortunately, we have an excellent vaccine that gives almost perfect protection against this disease.

d. *Encephalitis (Brain Fever)*. This is a dangerous virus disease of the brain and spinal cord. It is transmitted to man by the bites of both *Aedes* and *Culex* mosquitoes. Our best protection against it is the prevention of mosquito bites. This disease is present in the United States and in many areas overseas. Japanese B encephalitis is

one of the forms of encephalitis which caused sickness and death among troops in the Far East.

*e. Filariasis (elephantiasis).* This disease occurs in the Pacific and Far East areas. It is caused by a tiny worm which is injected into man by the bite of an infected mosquito. If there are only a few of these parasites in the body they will do no harm and will eventually die off. Natives who develop ugly, swollen limbs (elephantiasis) from this disease are those who have been exposed to huge doses of infection over a period of many years. Protection consists of preventing the bites of infected mosquitoes.

## Section II. CHARACTERISTICS OF MOSQUITOES

### 144. Life Cycle

Mosquitoes go through four stages of growth—egg, larva, pupa, and adult (fig. 32). The egg takes 1 to 3 days to hatch, the larva about 10 days to develop, and the pupa about 3 days before the adult emerges. (The exact number of days depends on the temperature and nutrition and the particular type of mosquito.) The larval and pupal stages of all mosquitoes are passed in water where the larvae, sometimes called wigglers, can easily be detected. In their adult or flying stage, certain mosquitoes, including the *Anopheles*—vectors of malaria—can fly at least one mile; *Aedes aegypti*—vectors of yellow fever—travel a few hundred yards; other species have been known to travel 100 miles or more when the wind is favorable. Male mosquitoes are harmless vegetarians; the females are bloodsuckers and are the transmitters of disease.

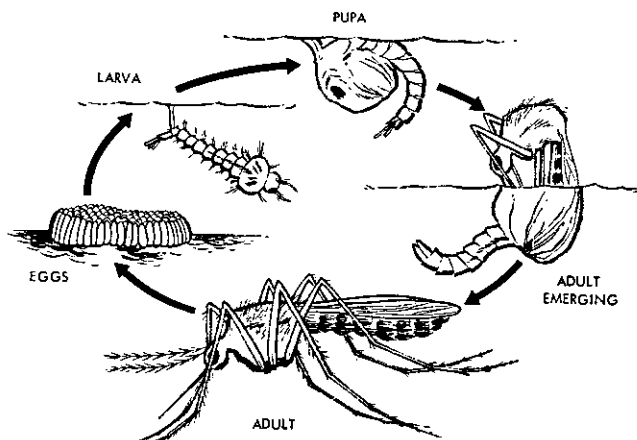

Figure 32. Life cycle of mosquitoes.

#### 145. Breeding Places

Mosquitoes will breed in practically any collection of water which stands longer than 10 days. Those breeding in and around human dwelling places are called domestic mosquitoes. Different kinds of mosquitoes vary in their choice of breeding places. Some like sunlit places; others prefer the shade; many breed in fresh water; others prefer the brackish water of salt marshes. Common breeding sites are ponds, swamps, slow-moving streams, drains, water receptacles, tree holes, and roof gutters. Stagnant water in bomb craters, road puddles, excavation sites, septic tanks, pit latrines, and other man-made water reservoirs may also serve as breeding places.

#### 146. Group Characteristics

The three most important groups of mosquitoes which transmit disease are the *Anopheles*, the

*Aedes*, and the *Culex*. Each of these groups consists of many species. The general characteristics of the three main groups are given below.

a. *Aedes*. Mosquitoes of this group transmit yellow fever, dengue fever, filariasis, and encephalitis (brain fever). Aside from the fact that these mosquitoes are important as disease vectors, they are also very annoying as pests. They breed in fresh or brackish water, in a variety of places such as rain barrels, fire buckets, roof gutters, forest pools, tree holes, bogs, swamps, and rock holes. The larvae are equipped with an air tube or siphon and, when breeding, hang at an angle to the surface of the water. The adults do not have spots on their wings. *Aedes* can be distinguished from *Culex* by two small, finger-like structures (cerci) projecting from the end of their abdomen. The adults rest and feed with their body parallel to the surface.

b. *Culex*. This group of mosquitoes transmits filariasis and encephalitis, particularly Japanese "B" encephalitis. *Culex* larvae are commonly found in water in and about buildings, also in stagnant water, swamps, ditches, street gutters, and cesspools. The common house mosquitoes found in the United States are members of this group. The adults rest and feed parallel to the surface as do the *Aedes* (fig.33). The larvae rest at an angle in the water. *Culex* adults are distinguished from *Aedes* in that they do not have cerci and from *Anopheles* in that they do not have spots on their wings.

c. *Anopheles*. Mosquitoes of this group transmit malaria and filariasis. They bite primarily at



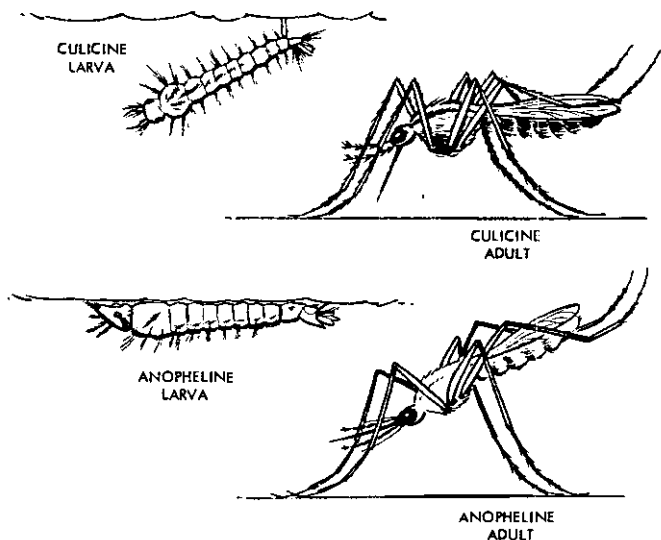

Figure 33. Typical positions of Anopheline and Culicine larvae and adults.

dusk, at night, and at dawn. They breed chiefly in ponds, streams, swamps, and man-made collections of water; and some species breed only in tree holes. Larvae lie parallel to the surface of the water. They do not have a long air tube or siphon as do the *Culex* and *Aedes*. Adults have spotted wings and usually rest and feed with the body at an angle of  $45^{\circ}$  to the surface (fig 33).

### Section III. CONTROL MEASURES

#### 147. Responsibility

Commanding officers are responsible for mosquito control in their respective areas (AR 40-205). In this activity they are advised by Army

Medical Service officers who conduct surveys and recommend the methods of control for each particular situation.

a. *Zone of Interior.* At posts, camps, and stations within the United States, insect control operations usually are performed by the post engineer. The Army Medical Service has the responsibility of conducting surveys to determine the requirements and the efficiency of these control operations. Preventive medicine units perform insect and rodent control tasks for training purposes only. When participating in field maneuvers, the commanding officer of each unit of company, battery, or similar size will appoint a vector control detail to perform insect and rodent control operations in his unit area. These vector control details must be trained in the importance of basic sanitation, individual protective measures, and unit protective measures. Preventive medicine units assist in the training of vector control details and supervise or conduct control operations in the areas beyond the boundary of military units as required.

b. *Combat Zone.* In the combat zone, commanding officers of all levels are responsible for insect and rodent control operations in their respective unit areas. For this purpose a vector control detail is appointed by the commanding officer of each military unit. The vector control detail controls mosquitoes in its unit area by destroying adult mosquitoes; by eliminating breeding by means of ditching, draining, and larviciding; and by residual spraying of quarters, mess halls, and latrines. This detail also conducts inspections to determine the effectiveness of individual protec-

tive measures required for the area, including the following: condition and use of screening and bed-nets; use of insect repellents; and use of protective clothing. Preventive medicine units assist in the training of vector control details in control methods and supervise extra-bivouac area mosquito control operations using military or civilian personnel.

#### **148. Camp Sites**

The ideal location for a camp site is on high, dry ground, at least a mile away from important breeding areas of mosquitoes and from native villages, since natives often are heavily infected with mosquito-borne diseases. At temporary camps it usually is more economical to control mosquitoes through the application of insecticides than it is to carry out large drainage projects. With the proper application of insecticides by means of both ground and aerial equipment, effective control over large areas can be accomplished.

#### **149. Larval Control**

Since all mosquitoes require water for their development, larval control is effected through the control of breeding areas. This is accomplished by proper drainage; elimination of standing water by the filling in of low areas; control of plants and debris along the shores of lakes or streams; removal or destruction of temporary water containers; and application of larvicides (chemicals) to the water which will act as poisons to the larvae.

a. *Larvicides.* Insecticides may be applied in various formulations. Only a small quantity of the

actual chemical ingredient is necessary to effect control. DDT in the amount of 0.1 to 0.25 pound of actual DDT per acre of water surface is sufficient. Formulations of DTD should be used for larval control until it is proven to be noneffective. (See par. 151 for the application rates of various insecticides.)

b. *Ditching and Drainage.* At fixed military installations, usually permanent-type ditching and drainage are employed. Antimosquito drainage can be accomplished by surface ditches (either lined, unlined, or rock-filled) or by subsurface drains. Regardless of the type of drainage selected, careful planning will increase its effectiveness. Grade lines should be established for at least the main ditches or drains. Sometimes the drainage system can be set up so that all of the water will collect in one area, and larvae can then be killed there more easily. Open ditches should be so dug that standing water is carried off and storm water is drained from ground and ditches within five days after a storm. Ditches should be wide enough and steep enough to accommodate all collected water, but the flow should not be so rapid that pot-holes will form in unlined ditches. If a ditch is too wide and too flat, water may remain in small depressions. Only as many ditches as are needed to accomplish the job should be constructed. Care must be taken to avoid creating new breeding areas while trying to fill or drain old ones.

c. *Artificial Containers.* All containers, such as discarded tin cans, oil drums, pails, old tires, barrels, or coconut shells which may collect water should be eliminated. When it is impossible to get

rid of them completely, as in the case of fire barrels, these breeding sites should be treated with a larvicide; otherwise, disease-carrying mosquitoes like the *Aedes* will multiply. The responsibility for cleaning up each nuisance should be clearly assigned and frequent inspections should be made to see that it is properly carried out.

*d. Filling.* At fixed installations it is advisable to fill nearby depressions and low areas which may become breeding sites. Man-made breeding sites like ruts, bomb craters, and foxholes can be filled; and the area of water surfaces can be reduced so that it is easier to spray with larvicides. Filling is slow and expensive but it is one certain and permanent way of controlling mosquitoes. In getting material for filling, care should be taken not to create new depressions which may fill with water and so become new breeding sites.

## 150. Adult Control

Adult mosquitoes are controlled by the use of insecticides; or by the use of mechanical barriers, such as screening, bednets, protective clothing, and chemical repellents.

## 151. Insecticides

All of the various formulations of DDT, lindane, dieldrin, and allethrin are effective against adult mosquitoes when used properly. All but allethrin are commonly used in residual-type applications. A residual spray is an insecticide that is applied to surfaces where insects may later come into contact with it and receive a toxic dose. A residual spray may remain toxic to certain insects for a

period of from a few days to several months. DDT has the longest residual effect against mosquitoes and should be used until qualified personnel have found it to be noneffective against adult mosquitoes. Within buildings, residual sprays are applied to the interior surfaces of walls and ceilings where mosquitoes usually rest when not feeding. Under certain conditions outdoor residual applications are sometimes made in the form of a protective barrier or zone between the breeding areas and human habitations by spraying shrubbery or other vegetation with water suspensions of the chemical. Aerosols applied into the air of inclosed spaces will kill insects in flight. Their effectiveness will last from a few minutes to several hours. The chemicals allethrin and pyrethrum possess properties which effect quick kills and are issued by the Army as aerosols.

*a. Insecticide, DDT-Oil Solution.* This formulation contains 5 percent DDT. It requires no dilution and is the preferred formulation issued to units for use by vector control details. It should not be used inside buildings or rooms where open flames are present. Inside buildings the material is best applied with the 2-gallon hand pressure sprayer (fig. 36). It is applied to the interior surfaces of buildings at the rate of 1 gallon per 1000 square feet of surface. The number of seasonal treatments required will vary with geographical locations and the abundance of adult mosquitoes. Some quarters may have to be treated every two months, while for others one annual application may be sufficient. To set up an effective program,

recommendations from qualified personnel of preventive medicine units should be obtained.

b. *Insecticide, DDT-Emulsifiable Concentrate.* This formulation contains 25 percent DDT and has been used quite extensively for outdoor mosquito and fly control. It is very useful for this purpose because the actual percent of DDT can be modified by the addition of water. At low concentrations it can be used on plants without danger of burning; it can also be used in buildings or areas where the use of oils might cause a fire hazard. When applied with the portable power sprayer (fig. 39) it is diluted to a low concentration, and a heavy application is delivered. Normally, this material is not issued to units in a combat zone, or to units participating in maneuvers in the zone of interior, but is reserved for preventive medicine units which have the necessary personnel and equipment to use the material properly. For preparation of various dilutions, see the appendix.

c. *Insecticide, DDT 75 Percent, Water Dispersible Powder.* Water is added to this material to prepare the desired concentration. It may be used on plants, shrubs, and grasses without danger of burning the foliage. It can also be used in buildings or other areas where there is a fire hazard. The material is applied with either the 2-gallon sprayer or the portable power sprayer. During use, the material must occasionally be stirred to prevent its settling.

d. *Insecticide, DDT, 100 Percent, Technical Grade.* The technical grade DDT, 100 percent, should never be used without dissolving in oil

(kerosene or fuel oil). Without the addition of a special solvent, kerosene will dissolve only enough DDT to make a 5 percent solution. Fuel oil will dissolve enough DDT to make a 10 percent solution. When prepared in the field without the special solvent, this solution should be used during that same season as it has a tendency to settle out during cold weather. Seven ounces of DDT to 1 gallon of kerosene or 1 pound of DDT to 2½ gallons of kerosene, will give approximately a 5 percent solution. DDT, 100 percent, is not issued to field units who do not have the qualified personnel and the necessary equipment for mixing it. If this material must be used it should be mixed by preventive medicine units and then placed in quartermaster supply channels for distribution.

**Caution:** DDT insecticide may be poisonous if it is absorbed through the skin in sufficient amounts. Often kerosene alone will cause skin irritation. The skin should be washed with soap and water if it becomes contaminated. Coveralls, or fatigues, and rubberized gloves should be worn when mixing or applying this insecticide. When applying in closed spaces, gauze mask or suitable respirator should be worn. Food, utensils, and table tops should be covered before spraying. Fires should be extinguished when oily sprays are used. Only trained personnel should apply this material.

*e. Insecticide, Lindane, Emulsifiable Concentrate.* This material is effective for the control of DDT-resistant flies, mosquitoes, mites, ticks, roaches, and fleas and should be used only against insects which cannot be controlled with DDT.



Lindane is about six times as toxic to houseflies as is DDT and produces a much more rapid knock-down than does either DDT or chlordane. It is very effective against chiggers, mites, and several species of ticks. For application as a residual spray in buildings, a 1 percent lindane solution is applied to surfaces at the rate of 1 gallon per 1000 square feet of surface. Temporary control of mosquitoes, flies, and sandflies may be obtained around camp sites and bivouac areas with a 0.5 percent lindane spray applied lightly to vegetation and other surfaces at the rate of from 5 to 10 gallons per acre. Mosquito larvae may be controlled by applying the spray as a fine mist at the rate of 3 gallons per acre of water surface. Mites, ticks, and flies may be controlled by the use of the above dilution at the rate of from 10 to 20 gallons per acre. A 5 percent lindane spray is suitable for aerial spraying against adult mosquitoes and is applied at the rate of one quart per acre in heavily vegetated areas, or one pint per acre in sparsely vegetated or open areas. Mosquito larvae can be controlled by applications of one quart of the 5 percent spray per acre of water surface from aircraft.

*f. Insecticide, Lindane, 75 Percent Water Dispersible Powder.* This concentrated powder should be used only under the supervision of trained Army Medical Service personnel. The finished spray must be prepared within as short a time as possible before use; and during the spraying operations it must be agitated in order to maintain a satisfactory suspension. Especially useful for the control of DDT-resistant flies, it may also be

used for the control of mosquitoes and sandflies. A 1 percent lindane water-dispersible spray is used for the residual control of mosquitoes, flies, and sandflies. When a camp site or bivouac area is to be occupied for only a few days, temporary control of mosquitoes, flies, and sandflies may be obtained by applying a 0.5 percent spray to all vegetation. This same spray may be used in the control of ticks, mites, and fleas, and is applied at the rate of from 10 to 20 gallons per acre, depending on the amount of vegetation and litter on the ground.

**Caution:** The acute toxicity of lindane is greater than that of DDT, and gross contamination of the skin should be avoided. When used as prescribed, the danger of poisoning is reduced to a minimum.

*g. Insecticide, Dieldrin, Emulsifiable Concentrate.* Insecticide, dieldrin, emulsifiable concentrate is issued in 5-gallon steel drums. Dieldrin emulsifiable concentrate contains 18 percent dieldrin. It is highly toxic to mites, ticks, and insects, and is stocked by the Army to provide control of insects when DDT is not effective. DDT-resistant mosquitoes, flies, and fleas are adequately controlled by residual applications of a 0.5 percent dieldrin spray. For area control of adult mosquitoes and flies, this spray should be applied to vegetation at the rate of from 5 to 10 gallons per acre. Dieldrin emulsifiable concentrate may be used as a mosquito larvicide when it is mixed 1 part dieldrin to 49 parts water (2 ounces per gallon of water). This 0.3 percent dieldrin spray should be applied as a fine mist to breeding areas at the rate of from 2 to 4 gallons per acre. Against ticks,

mites, and fleas a slightly heavier concentration is necessary. A 0.5 percent dieldrin spray can be applied at the rate of from 10 to 20 gallons per acre, depending upon the density of vegetation in the area. Dieldrin emulsifiable concentrate may also be used in preparing aerial spray by diluting with fuel oil to form a 3 percent solution. This should be applied at the rate of 2 quarts per acre, which will give a deposit of approximately 0.125 pound of dieldrin per acre.

*h. Insecticide, Dieldrin 50 Percent, water Dispersible Powder.* This insecticide may be used in the same manner as outlined in *g* above.

**Caution:** Dieldrin is dangerously toxic and should not be used in mess halls or near food. Contamination of the skin or inhalation of sprays or dusts should be avoided. In case any of the material is spilled on the skin, it should be removed immediately with soap and water. Concentrated solutions should be handled with care and diluted with specified amounts of water before use. When these precautions are followed, toxicity hazards are reduced to a minimum.

*i. Insecticide, Aerosol, DDT, and Allethrin 12-Ounce Dispenser.* DDT is added to the formulation to insure the killing of insects knocked down by the action of allethrin. This is a low-pressure aerosol bomb in a 12-ounce beer-can type dispenser (fig. 34). It is used to kill flying insects in tents, foxholes, bomb shelters, barracks, and other quarters or shelters. The aerosol bomb cannot be used to apply a residual spray. Its toxic action is immediate but of only temporary duration. Seven seconds of spraying per 1,000 cubic feet, or

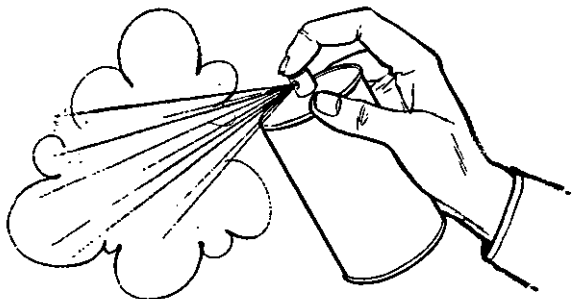

Figure 34. Aerosol bomb.

roughly 22 seconds for a squad tent, is sufficient time. The dispenser should be carried quickly to all corners while the aerosol is escaping. Dispensers may be supplied to men in combat areas along with food, ammunition, and first-aid supplies. Shelter tents and dugouts are sprayed at dusk and at other times when mosquitoes bite, to keep out the insects as well as to kill them. A few seconds of spraying is enough for an ordinary shelter.

## 152. Individual Protective Measures

a. *Malaria Discipline.* The equipment and supplies issued to an individual for his use as protection against mosquitoes and other insects are called individual protective items. Such items include protective clothing, headnets, bednets, repellents, insect powders, aerosol bombs, and suppressive drugs. Because malaria is considered to be the most important of the mosquito-borne diseases, the term "malaria discipline" has been used to describe the training of individuals in the proper and consistent use of items issued for their per-

sonal protection. The closer a man gets to combat, the more important it is that he should know how to use and take care of these protective items. Troops with malaria cannot fight. Instruction given in training periods should be repeated when necessary and applied on field maneuvers. Commanders will strictly enforce individual measures for insect and malaria control. A man in a foxhole or on the front line can protect himself reasonably well if he knows how to avoid infection and realizes the importance of doing so.

b. *Clothing.* This includes gloves, headnets, and impregnated clothing. The wearing of shorts as an outer garment during the hours from dusk to dawn should be prohibited; and after dark men should not be allowed outdoors without shirts. This type of control can be effected only by strict discipline and frequent inspection.

c. *Nets.* Headnets afford excellent protection for the face and neck and are particularly useful in areas where biting flies and mosquitoes are abundant, as in the arctic during summer. Bednets or "mosquito bars" protect men during sleep. The malaria-carrying mosquito usually bites at night; therefore, the nets must be so arranged that mosquitoes cannot bite persons through the net. Before getting under a net at night, release the aerosol bomb for a few seconds inside the netting in order to kill any mosquitoes that may be under the mosquito bar. Cots and beds should be provided with overhead frames which have no sharp points that might tear the netting (fig. 35). Holes in the net should be repaired promptly with needle and thread, with adhesive tape, or by tying string

around the pinched-up torn part. Hang shelter tent nets inside, not outside. The importance of nets cannot be overemphasized; they should always be carried as personal equipment by all troops entering a malarious area, even in forward combat areas. There are places in the tropics where 20 percent of the troops have caught malaria during a single night's exposure without the protection of nets.

*d. Repellents.* Insect Repellent, personal application, 2-ounce bottle is the standard repellent issued by the Quartermaster Corps for individual protection of exposed skin surfaces. The standard clothing insect repellent is: Insect Repellent, clothing application, 1-gallon can. Insect repellents are

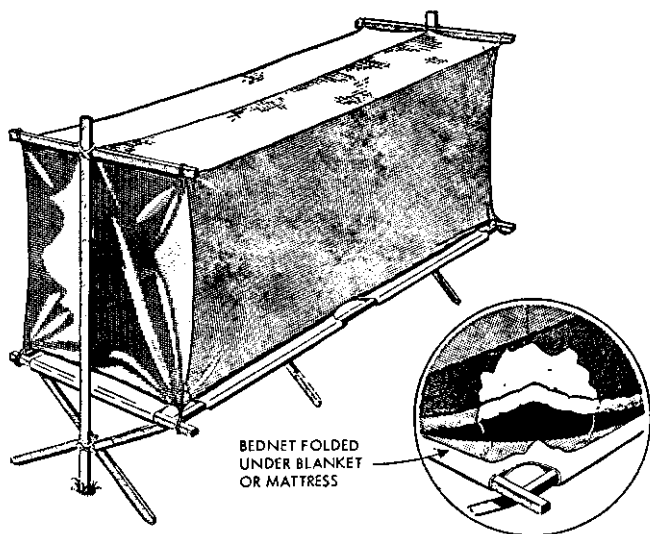

*Figure 35. Mosquito bednets on folding cot.*

chemicals which, when applied to the skin or clothing, repel biting insects. Standard insect repellents furnish protection for from 2 to 4 hours after they have been applied to the skin. Repellents should be applied freely to exposed skin and close-fitting parts of clothing, especially when the use of other protective measures is not feasible. Since some repellents will dissolve plastics, apply the repellent in such a manner as to prevent contact with plastic items. As a rule, repellent will last much longer when applied to clothing than when applied to the skin; but for maximum protection both the exposed skin and the clothing should be treated. Remember that no insect repellent is 100 percent effective for long periods of time; therefore, repeat applications as often as necessary to prevent the insects from biting.

### **153. Unit Protective Measures**

Unit control and protective measures are accomplished by vector control details. Sufficient quantities of supplies and equipment are issued to units to meet insect control problems within their unit area. In a combat zone the unit's responsibility for mosquito control generally extends over the immediate vicinity up to 100 yards from the perimeter of the area occupied by the unit. If only minor breeding areas are involved, the area may be extended further. Clearing away mosquito resting places such as tall grass, brush, and leafy vines and bushes; applying larvicides to breeding areas; space spraying; and residual applications to tents, latrines, and buildings—all will help in the control of mosquitoes and other insects in the area. During

maneuvers in the zone of interior, vector control details will perform duties similar to those accomplished in a combat zone. In garison, the vector control detail will constantly inspect the unit area to determine whether normal housekeeping responsibilities are being accomplished, and will correct minor deficiencies such as the repair of window and door screens, clean and maintain small surface drains, and supervise the accomplishment of individual protective measures when required.

#### 154. Unit Control Equipment

The equipment issued to units for unit control in a combat zone are the 2-gallon compression sprayer and the hand dust gun. In certain units and specific areas an insect-proof liner may be authorized for use in tents. In the zone of interior the equipment issued to units will be in accordance with positive requirements for control of disease vectors and for training .

*a. Hand Pressure Sprayer, 2-Gallon (fig. 36).* The 2-gallon compression sprayer is an item of engineer issue—Sprayer, insect, knapsack, cylindrical, 2-gallon. Personnel operating this sprayer must be trained in its operation and maintenance. At the end of each day's operation the sprayer should be flushed with water so as to remove any of the liquid spray remaining inside the tank, hose, wand, and nozzle. At weekly intervals a drop or two of oil should be applied to the inside wall of the pump cylinder. A box should be constructed for protection of the sprayer during storage and transport.



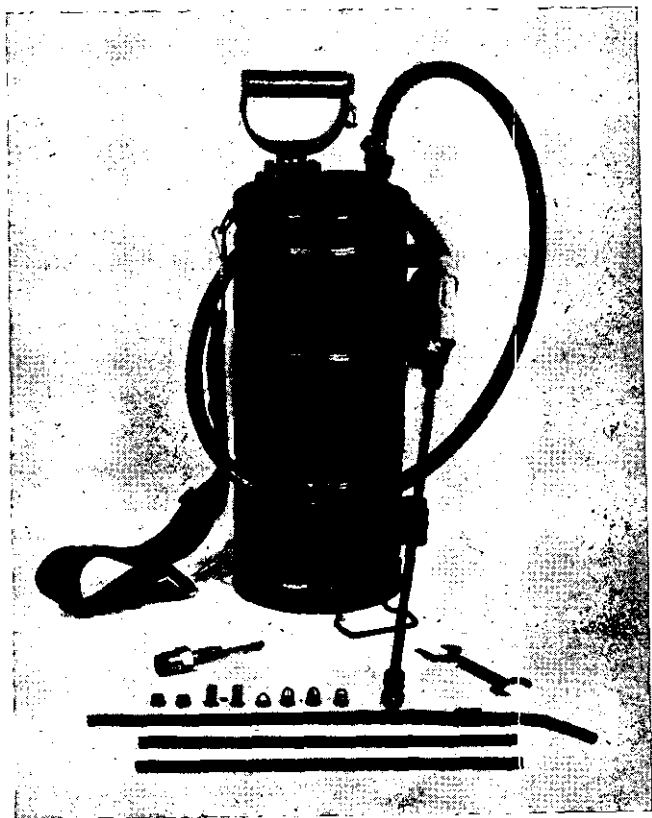

*Figure 36. Hand pressure 2-gallon sprayer.*

*b. Hand Dusters.* Duster, insect, hand, pump type. This item is a plunger-type duster for use in dusting individuals with louse powder and for the application of dusts for the control of mosquito larvae, fleas, ants, and other insects. The only maintenance required is a drop of oil applied occasionally to the pump cylinder. This duster

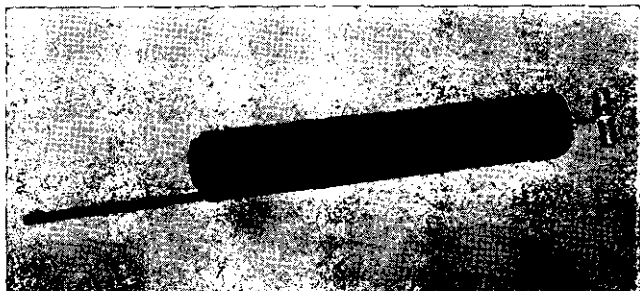

*Figure 37. Hand duster.*

operates best when the dust cylinder is not filled over three-quarters of its capacity (fig. 37).

### **155. Mosquito-Proofing**

All buildings where men gather should have fine mesh screening (18 mesh) on doors and windows. Screen doors should open outward and close automatically. They should be of sturdy construction so as not to warp or sag, and at hand and foot levels they should be reinforced with cross-strips of wood or metal. Strips of wood or metal should also block any spaces between the frame and the door where mosquitoes might enter. In highly malarious areas, entrances should have a vestibule with double screen doors at least six feet apart and opening outwards. All openings in screened buildings, such as cracks, knotholes, spaces in flooring, walls, or corner joints should be closed with pieces of tin cans, shingles, or a mastic made by boiling shredded paper and flour into a doughy mass and adding sand and cement. Torn screening must be repaired promptly. At permanent posts, camps, and stations the post engineer performs major

mosquito-proofing operations; but the occupants of each barracks building are responsible for their own minor repairs. Because this measure is so important to the health and comfort of all personnel it should be strictly enforced. Unit vector control details should be given the duty of making regular inspections, necessary minor repairs, and promptly reporting major repair requirements.

#### 156. Area Protective Measures

Area insect control is performed under the supervision of preventive medicine units. These units are capable of performing and supervising control operations over large areas against arthropod-, rodent-, or water-borne diseases. Usually, these units are available at the army, corps, or division level.

a. *Equipment.* The equipment used by these units for area control includes all items used for individual and unit protection and all other available items of equipment: 2-gallon hand sprayer; aerial spraying kit; and power mist sprayers and fog machines.

- (1) *Rotary duster* (fig. 38). Duster, insect, hand, rotary-blower type, 5- to 10-pound capacity. This duster is used for applying various insecticide dusts for control of mosquito larvae, flies, fleas, and other insects. It is issued to all preventive medicine units and to post engineer personnel, as required. Normally, it is not issued to other units.
- (2) *Power sprayer* (fig. 39). Sprayer, insecticide, portable, gasoline engine-



*Figure 38. Rotary duster.*

driven, 3 GPM, M-1. This portable sprayer is capable of applying all types of insecticides issued by the Army. Usually it is operated from a jeep trailer or weapons carrier in applying insecticides to mosquito breeding areas, vegetation, or ground. This equipment is issued to preventive medicine units and to engineer insect and rodent control teams who are trained in its operation and maintenance.

- (3) *Hand pressure sprayer.* For a description of this item see paragraph 154a.
- (4) *Aerial spraying kit.* This kit is designed for use with an L-19 liaison-type plane or a helicopter. It is issued only to preventive medicine units whose personnel are trained in its operation and use. This equipment is used where conditions do not demand large aerial control projects; for aerial spraying of spots that cannot



*Figure 39. Portable power sprayer.*

be reached from the ground, such as mine fields; and in emergencies when immediate relief is required.

- (5) *Mist machines and fog machines.* These items are used by preventive medicine units for area control and by engineer insect and rodent control teams. The procurement of these items depends on conditions in the area to be controlled and on the recommendations of the area surgeon.

*b. Residual Spray.* The use of DDT or other approved insecticide as a residual spray to kill adult mosquitoes in houses as well as in their outdoor resting places is an important addition to present methods of mosquito control (par. 151a).

Native quarters, villages, and cities may be treated with a residual spray if there is a threat of an insect-borne disease epidemic.

*c. Space Spraying.* Aerosol bombs may be used to rid enclosed spaces of flying insects (par. 151*i*). When antitank gun emplacements, pill-boxes, and sentry huts are occupied at night they should be sprayed every three hours, or at least at dusk and just before dawn.

#### Section IV. INSECT RESISTANCE

##### 157. General

Many insects, including mosquitoes, flies, lice, and roaches, have developed resistance to insecticides. This means that an insect can survive in the presence of a chemical which formerly was deadly to it. It does not mean that every insect of this kind will survive the application of the insecticide, nor does it mean that the resistant insects will live indefinitely in the presence of a heavy application. Insects are said to be resistant if a sizable number can survive after contact with an insecticide which has been applied at a practical dosage.

##### 158. Development of Resistance

Like other animals, insects vary in the effect that diseases, chemicals or other injurious things have upon them. Thus, when insecticides are applied at normal rates, not all of the exposed insect population will receive a death-dealing dose. Because they naturally can tolerate or withstand more than others, some will survive. Those that survive will mate and pass on to their descendants

the ability to withstand the insecticide; and this condition is repeated with each generation as long as exposure to that insecticide continues. Careless spraying may result in the deposit of an insufficient amount of material so that the most susceptible insects are killed while the hardier ones are left to multiply. Insects are known to have developed resistance to every insecticide that is used by the Army. An important point to remember is that insects can develop resistance to different kinds of insecticides at the same time. This means that if several chemicals are used together, the chance of rapidly exhausting the supply of effective insecticides is thereby increased.

#### **159. Precautions**

a. Use insecticides properly; improper use will build up resistant insect populations that will be difficult to control.

b. Do not use mixtures of insecticides; insect populations can develop resistance to many kinds of insecticides at the same time.

c. Watch the effectiveness of the insecticides that have been applied. If control becomes unsatisfactory even though the insecticides have been applied properly, report this situation to the commanding officer who is responsible for forwarding the information through technical medical channels.

Table I. *Material and Personnel Involved in the Three Phases of Insect Control*

| Individual protection  | Unit protection   | Area protection  |
|--|---|--|
| <p>(Individual soldier).<br/> <i>Material</i><br/>                     Repellents<br/><br/>                     Bednets<br/>                     Headnets<br/>                     Protective clothing<br/>                     Aerosol bombs<br/>                     Insect powder<br/><br/>                     Malaria suppressives.</p> | <p>(Vector control details).<br/> <i>Material</i><br/>                     2-gallon sprayer<br/><br/>                     Hand dust gun<br/>                     5 percent DDT solution.<br/>                     Space spray<br/>                     Insect powder<br/><br/>                     Fly swatters</p> | <p>(Preventive medicine units).<br/> <i>Material</i><br/>                     Aerial spraying equipment.<br/>                     Power sprayers.<br/>                     Power fogging machines.<br/>                     Delousing machines.<br/><br/>                     Rotary dusters.<br/>                     All insecticides.<br/>                     All rodenticides.<br/>                     All material issued for individual and unit protection.</p> |



# CHAPTER 9

## LOUSE-BORNE DISEASES AND THEIR CONTROL

---

### Section I. INTRODUCTION

#### 160. General

*a. Military Importance of Louse-Borne Diseases.* Louse-borne diseases have always been a threat to fighting forces. Their history dates back to the earliest recordings of mankind. Wars have been lost through casualties caused by louse-borne typhus.

*b. Distribution.* Human lice are distributed all over the world. They thrive during famines and wars and among people suffering economic hardships. Whenever large groups of people are deprived of homes, clothing, and bathing facilities, lice usually appear. They are particularly associated with cold weather; and while lice are also present in the higher altitudes of the tropics, they are found more commonly in temperate and subarctic areas where clothing is heavy and is worn in several layers.

#### 161. Louse-Borne Diseases

The louse-borne diseases are typhus (epidemic type), relapsing fever, and trench fever. Of these, epidemic typhus is the most important. Trench fever was present in European armies during World War I, but it has not been identified since

that time. Both typhus and trench fever are caused by a special type of germ called *Rickettsia*. Relapsing fever usually is present wherever epidemic typhus occurs, and cases have occurred among American troops both in World War II and in Korea. All of these diseases have this in common: they are spread from man to man by lice; they are serious infections and a special threat to armies; and they occur in epidemics. We have a good vaccine against typhus but as yet none for relapsing fever or for trench fever.

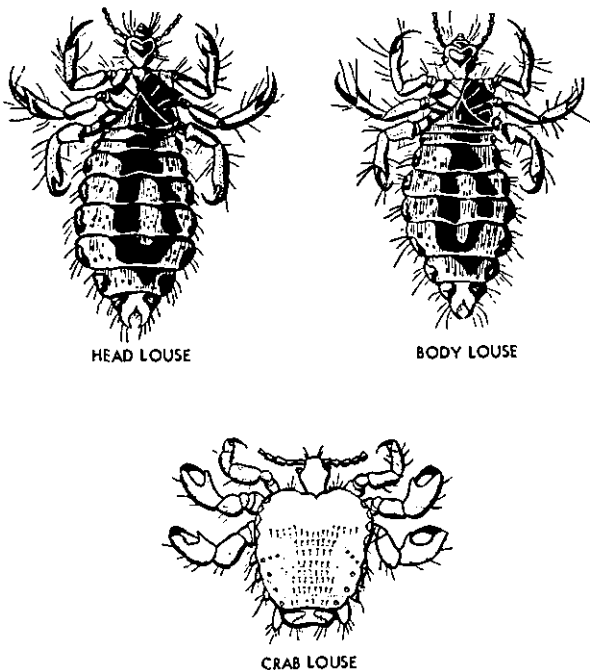

Figure 40. Human lice of medical importance.

## Section II. CHARACTERISTICS OF LICE

### 162. Classification

Three species of lice are of special medical importance; the body louse, the head louse, and the crab louse (fig. 40).

a. The body louse (*Pediculus humanus humanus*) is the vector of louse-borne typhus, also known as epidemic typhus.

b. The head louse (*Pediculus humanus capitis*) is considered to be of lesser importance in the transmission of disease.

c. The crab louse (*Phthirus pubis*) is probably of no importance in the transmission of disease but is important as an annoying pest.

### 163. Life Cycle

All lice have three stages of growth: the egg, the nymph, and the adult (fig. 41).

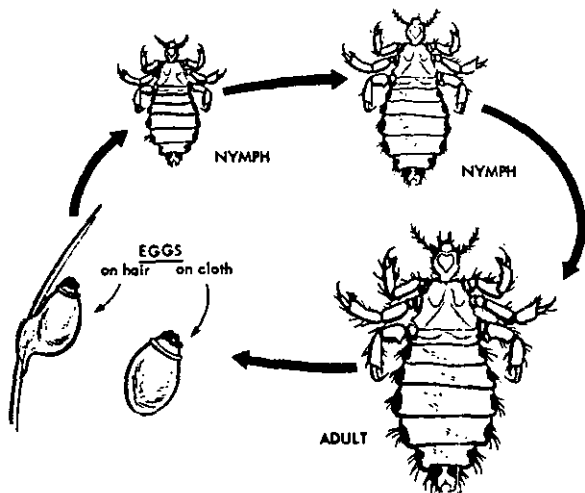

Figure 41. Life cycle of lice.

## 164. Body Louse

a. The body louse attaches its eggs to the fibers of clothing, especially along the seams, and occasionally to body hairs. The eggs are white in color, oval in shape, have a lid on one end, and are about the size of the period at the end of a sentence. At temperatures of from 86° to 90° F., eggs will hatch into nymphs in about 8 days; but at lower temperatures the hatching process may take 2 weeks or more.

b. Nymphs (immature forms) are similar to the adult, except that they are much smaller (pin-head size). Unless they obtain a meal of blood within 24 to 48 hours after hatching, the nymphs will die. The nymphal stage lasts about 9 days, after which the louse is a mature adult.

c. Adult females begin to lay eggs 4 days after maturity, at the rate of from 5 to 10 eggs a day. Under favorable conditions they will continue the laying process for 30 days. Except when feeding, the adult louse remains in the person's clothing.

## 165. Head Louse

This species, which is a close relative of the body louse, prefers the hairy parts of the body, particularly the head, where it attaches its eggs to the hair. Its life cycle is similar to that of the body louse.

## 166. Crab Louse

This species, which has a short body with long legs that end in claws, is recognized by its crab-like appearance. It infests the armpits, beard, eyebrows, and eyelashes, but particularly the pubic

regions. Females will lay about 20 to 50 eggs which they attach to the body hairs. The incubation period requires from 7 to 10 days. It takes about 15 days for nymphs to reach the adult stage.

#### 167. Characteristics of Lice

a. Lice live on human blood. If unable to feed they will die in a relatively short time. In the higher temperatures, lice require more food and die even more quickly if deprived of it.

b. Lice are spread by contact with infested persons or when adult lice or eggs drop off into straw, debris, blankets, clothing, or on latrine seats. Crab lice are frequently acquired during sexual intercourse with an infested individual.

c. Disease is seldom transmitted by the actual bite of the louse. The germs (*Rickettsia*) of typhus are contained in the gut of the louse and are passed out with the droppings of the louse when it feeds. Louse bites itch and cause scratching during which the *Rickettsia*-laden feces are rubbed into the tiny skin abrasions. Scratching also may crush the louse and rub the germs it contains into the wound. This is true especially in the case of relapsing fever.

### Section III. DELOUSING METHODS

#### 168. Indications of Lousiness

In every military campaign, provisions to combat lice must be made in advance. Head and crab lice present individual problems, but from the standpoint of disease they are of no great importance. When troops are located in areas where the civilian population is lousy the chances are that

troops will become infested, particularly if facilities for bathing and changes of clothing are not available. Under such conditions frequent inspections must be made. Lice are not easy to find and may become quite numerous before they are noticed. Whenever a person's skin shows evidence of scratching or of insect bites he should carefully examine his clothing for lice, particularly at the seams where eggs and young lice are most likely to be found. When one infested person is found, all other personnel in that particular unit should also be examined.

#### **169. Requirements for Delousing a Unit**

If during any unit inspection 5 percent or more of the personnel are found to be infested the entire unit should be deloused, using mass delousing procedures. If less than 5 percent are lousy, the infested individuals and the remaining personnel in the unit should be required to dust themselves with 2-ounce cans of delousing powder. Weekly inspections should be made by the medical officer to determine the efficiency of the operation. Clothing should be changed as soon as possible, with bathing before the clothing change. In all areas where natives are known to be infested, personnel should use louse powder routinely as a preventive measure and should be warned to stay away from the natives.

#### **170. Insecticides**

DDT has been the basic louse powder since it was made available during World War II. In 1951 the strain of lice in Korea was found to be resistant to DDT (par. 157), hence a substitute powder

(lindane) was made available. The Army now issues three insecticides for the control of lice: 10 percent DDT powder, DDT delousing spray, and 1 percent lindane powder. Louse powders are effective against all three forms of lice.

a. *Insecticide, DDT, Powder, 10 Percent DDT, 2-Ounce Can.* This powder contains 10 percent DDT and 90 percent talc. It is issued for individual louse control in 2-ounce cans.

b. *Insecticide, DDT, Powder, 10 Percent DDT, 25-Pound Pail.* This powder has the same ingredients as *a* above. It is packed in 25-pound cans and is issued for the mass delousing of personnel and for the control of mosquito larvae, fleas, and ants. For mass delousing it is applied with the hand duster (fig. 37) or with the powder delousing machine (fig. 42).

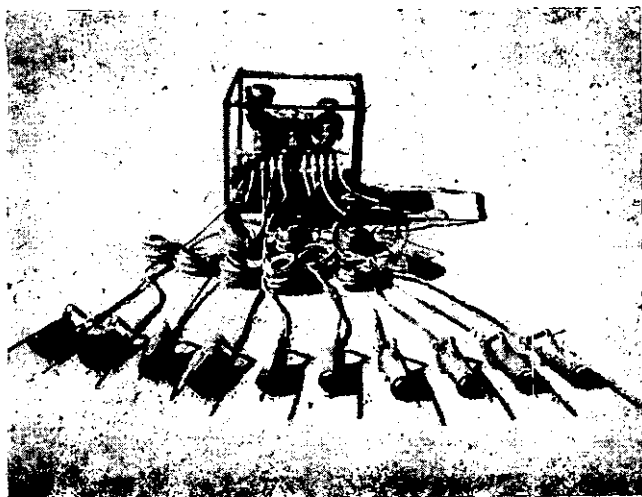

Figure 42. Power delousing unit.

c. *Insecticide, Lindane, Powder, 1 Percent, 2-Ounce Can.* This material contains 1 percent lindane and 99 percent talc. It is effective against lice, fleas, and bedbugs. The amount used per person should be limited to not over two ounces per week.

d. *Insecticide, Lindane, Powder, 1 Percent, 25-Pound Drum.* This material is supplied in 25-pound containers. It is issued in bulk for mass delousing. The hand duster or the power delousing machine is used for applying the material. It contains the same ingredients as *c* above, and in its use the same precautions must be observed.

e. *Insecticide, DDT, Liquid, 6 Percent DDT (Delousing Spray).* This liquid delousing spray contains 6 percent DDT, 68 percent benzyl benzoate, 12 percent benzocaine, and 14 percent emulsifier. This stock solution must be diluted just prior to use—1 part of concentrate to 5 parts of water—and is to be used only on recommendation of a medical officer. It is very effective for the control of head, body, and crab lice. It kills the eggs as well as all other stages of the lice. This material was formulated primarily for use at delousing stations. After personnel have bathed, and prior to the issue of freshly laundered clothing, the insecticide is sprayed over the body, with special coverage for the hairy portions, and should be allowed to remain for at least 24 hours before the next bath is taken.

#### 171. Application of Insecticide

a. *Head Lice and Crab Lice.* To get rid of these pests, dust the hairy portions of the body



with the louse powder and let it stay on 24 hours or longer. Apply powder again after 1 week to kill lice that may have hatched in the meantime. If louse *spray* is available, use it instead of powder because it will kill both the eggs and the lice. Examine the hairy parts of the body closely at the end of the week or 10 days to be sure that no living lice are present. If the hair is cut short it will be more difficult for the lice to hide in it and it will also be easier to apply powder and spray. The shorn hair should be collected and burned.

b. *Dust Guns.* Louse powders may be applied with a hand dust gun (Duster, insect, hand, pump type) or a power duster (Outfit delousing, gasoline engine driven). The powder compartment of either type is filled about three-fourths full of louse powder. Before beginning operations, delivery of the powder should be tested in the open and the flow should be so adjusted as to get a heavy cloud of powder from the outlet tube. Delousing is done without having the clothing removed, and in such a manner that the inside of garments next to the body, as well as the body itself, is covered with powder. Operators doing this work for the first time should check results by examining the skin and garments of the first few men dusted. If done properly, powder should cover the underwear entirely and should be visible on the body hairs of the chest, back, armpits, crotch, and thighs. Since body lice are most often found in the seams of clothing, particular attention must be given the neck, armpits, waist, shirt-tail, and crotch of clothing. The men loosen their collar, tie, and belt, and then stand or sit (which-

ever is most suitable) with hat in hand. The routine for dusting given below should be followed (fig. 43).

- (1) First dust the head, having the subject rub the powder into his hair until it is whitened. Then dust the hat and replace it on head.
- (2) Insert the nozzle of duster into the right sleeve next to the skin, with subject's arm outstretched to side at shoulder height, and direct the flow of powder toward the armpit. With power duster, hold trigger down until powder is seen to come from the loosened neck of shirt.

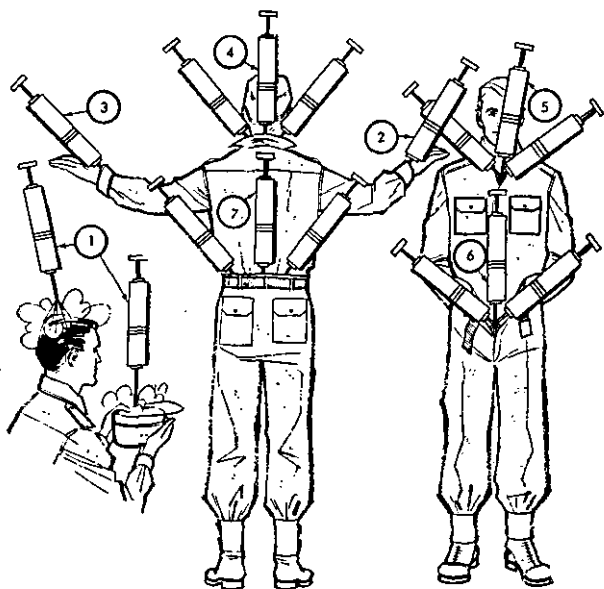

Figure 43. Delousing procedures.

Subject's face should be turned away from the side being dusted. Repeat the operation for left sleeve next, or after (4) below.

- (3) Insert the nozzle inside the shirt collar at front next to skin, below powder toward right armpit, toward front waistline, and toward left armpit. Operator stands in front; subject leans forward with head tipped back.
- (4) Insert the nozzle inside the shirt collar at back next to the skin; blow powder toward right side, toward back waistline, and toward left side. Operator and subject remain in the same relative position as in (3) above but with subject's chin on his chest. Be sure that some powder is dusted on the collar where lice like to hide.
- (5) Insert the nozzle inside the top of loosened drawers at front next to the skin, having subject stand (if he has been sitting); blow powder toward his right side and leg, toward crotch, and toward his left side and leg. Operator remains in front.
- (6) Insert the nozzle inside the top of loosened drawers at back next to the skin; blow powder toward his right side and leg, toward buttocks, and toward his left side and leg. Operator may remain in same position as in (3), (4), and (5) above, and have subject turn around; or operator may walk around to back of subject.

- (7) When hand dusters are being used, two full, even strokes per area are required. With power dusters, a momentary pressure on the trigger usually is all that is necessary. The exact timing must be learned by experience.
- (8) For female personnel the same general procedure give above should be followed, if women operators are available. Otherwise, liberal use of the powder at the neck and sleeve levels next to the skin may be sufficient.
- (9) If a power dust gun is used, dusting of individuals and of clothing can be done more rapidly and with the use of less powder, because the power gun is easy to manipulate and gives a uniform cloud of dust. This is the ideal method for mass delousing.

## 172. Use of Sifter Can

For the dusting of small numbers of personnel it is sometimes more convenient to have each individual apply powder to his own clothing. The powder may be dusted on clothing from the sifter can (insecticide powder, louse, 2-ounce can) or from any improvised shaker; however, the clothing must be removed. Powder the inside of the hat. Lay the coat, with sleeves turned inside out, on a table; spread coat wide open so that the whole inside can be seen; then powder inside, taking particular care to get powder along the shoulder and armpit seams and down the arms. Next, lay the trousers, turned inside out with the seat

uppermost, on top of the coat. Powder all seams, particularly at the crotch, and shake powder down the seams of both legs. Then powder the shirt like the coat. The underwear should be turned inside out and powdered thoroughly, again paying particular attention to all seams. Shoes usually are not powdered. Fold the entire pile of clothing and give it a few sharp blows so as to fluff the powder about; then the clothes are ready to wear. Repeat the powdering with each change of clean clothes before putting them on. This will prevent reinfestation.

### **173. Delousing Spray**

Insecticide, spray, delousing is supplied mainly to delousing plants at ports (par. 170*e*). It is used in connection with gas or steam disinfection methods.

### **174. Treatment of Extra Clothing and Bedding**

Although 99 percent of all lice are found on a person's body or on the clothes he is wearing, extra clothing and bedding may be infested and cause reinfestations.

*a.* When dusting extra clothing and bedding with a dust gun, place the delivery tube between the layers of clothing in order to speed the job and avoid wasting powder. If mattress covers are not in use, place a blanket over the mattress and dust between the two, taking care to reach the sides and seams. Blankets are dusted by piling one on top of another and dusting between every two blankets; or by folding and dusting between two layers of the same blanket; or by holding a folded blanket in the air (if help is available) or

hanging it over a line and dusting between the fold. When the whole job is finished, each pile of blankets should be given several blows in order to spread the powder and work it into the seams and patches.

*b.* When a dust gun is not available, use the shaker can on each successive layer of bedding; the surface of one blanket will then spread the powder by its contact with the under surface of the next. After the pile has been dusted, beat or fluff lightly to distribute powder evenly. Canvas packs, duffle bags, boxes, footlockers, and similar items also may need dusting.

### **175. Comments on Dusting**

*a.* The amount of powder required for one complete individual dusting depends on how much clothing and bedding is to be dusted. The underwear surface next to the skin is the most important. From 1 to 1½ ounces of powder are required per person.

*b.* The arrangements for dusting depend upon the size of the group, the layout of the camp, and the opportunity for getting the men and their bedding together: the object being to dust all of the men and the bedding at the same time. Unit members who are absent should be scheduled for later dusting, since if anyone is omitted there is danger that he may reinfest the group.

*c.* Infested native laborers and troops who work closely with American personnel should be given at least monthly dustings. This will give sufficient protection even if their clothing is not changed during that period.

*d.* The time between dustings in a prison camp or other isolated group depends upon the success of the first job, the rapidity of reinfestation, and the general hygiene of the group concerned. Before the redusting of an entire group is ordered, a careful inspection should be made of the innermost clothing of several members of the group, giving special attention to seams at the arms, armpits, neck, waist, and crotch. Where 5 percent or more of those examined are found to be lousy, the entire group should be redusted.

*e.* In dusting large numbers of refugees and prisoners of war, teams should be organized to include an officer or noncommissioned officer in charge, interpreters, gun operators and personnel to fill the dust guns. The men who are doing the dusting may rotate with the men who are filling the dusters and opening the cans. The operators should wear dust masks. Operating continuously, a crew and one machine can dust approximately 6000 persons per day. In prisoner-of-war compounds, dusting usually can be performed by a crew of selected and trained prisoners.

## **176. Bathing**

Whether or not the individual is infested with lice, bathing is important for personal hygiene and baths should be taken as often as possible. Men should bathe while their clothing and equipment are being deloused, except when powder is being used. In the field, quartermaster bath units, or improvised showers are used. For details pertaining to the construction of improvised showers, see paragraph 73.

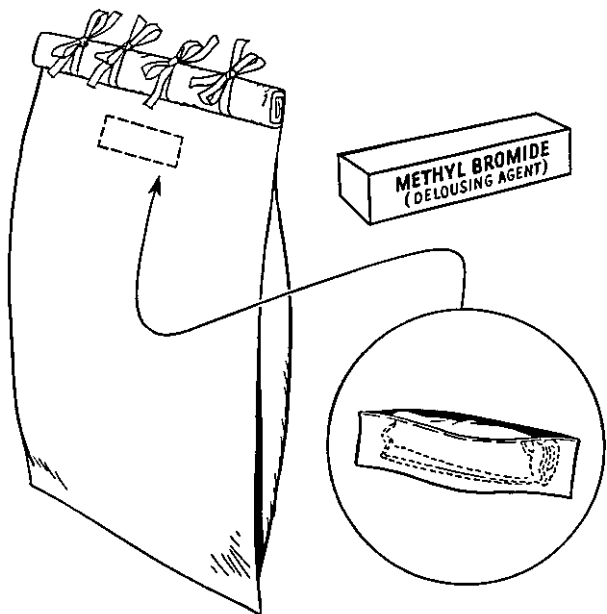

*Figure 44. Methyl bromide fumigation bag (Insert indicates location of inner pocket for placement of ampule).*

### **177. Methyl Bromide Fumigation**

Methyl bromide gas kills both the lice and their eggs. It is supplied in 20 cc. ampuls, 1-lb. cans, and 150-lb. cylinders and is used in plastic delousing bags and fumigation chambers. It is used only upon recommendation of the surgeon and by, or under the supervision, of preventive medicine units (fig. 44).

### **178. Delousing Plant**

At ports of embarkation or debarkation, special delousing plants may be established to provide mass bathing and delousing facilities.



# CHAPTER 10

## FLY-BORNE DISEASES AND THEIR CONTROL

---

### Section I. INTRODUCTION

#### 179. General

Houseflies are found all over the world, but are more abundant in warmer climates. The housefly is the most important of the nonbiting species in the transmission of disease, and comprises the majority of all flies found in kitchens and dining rooms.

#### 180. Fly-Borne Diseases

The medical history of past wars indicates that the health of troops has been seriously affected by flies. They may carry the germs that cause typhoid, cholera, and dysentery. In the tropics, various skin and eye diseases may be spread by the housefly. There is evidence that they may be connected with the transmission of other diseases.

#### 181. Method of Transmission

Flies transmit disease organisms on the tiny hairs of their body and feet and in their feces and vomitus. Flies may bring disease organisms directly from a manure pile or from human feces to food.

### Section II. CHARACTERISTICS OF FLIES

#### 182. Life Cycle

The common housefly (*Musca domestica*) goes

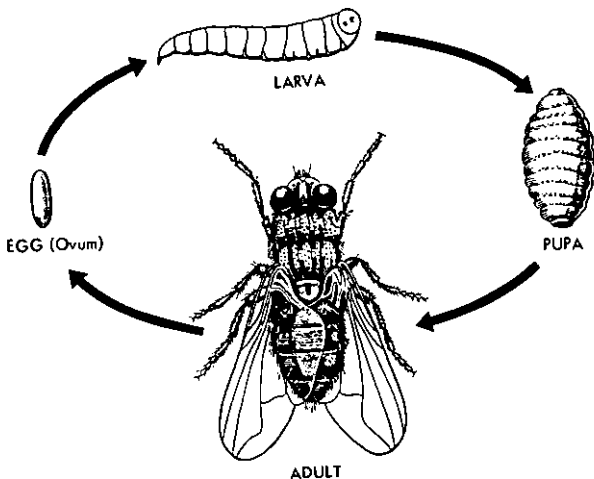

Figure 45. Life cycle of common housefly, *Musca domestica*.

through four stages during its life cycle: egg, larva, pupa, adult (fig. 45).

a. *Egg*. The female fly lays eggs in clusters of 120 or more, in filth such as manure, garbage, rotting fruit or vegetables, and decaying organic matter. During her life a fly will lay an average of 1,000 eggs. The eggs are white ovals, about the size of a period at the end of a sentence. Depending upon temperature and other conditions, the egg stage lasts from 5 to 36 hours.

b. *Larva*. Newly hatched larvae, or maggots, are about twice the size of the eggs. They move about, feed on organic matter, grow rapidly, and under favorable conditions will reach the pupal stage in from 5 to 8 days. When fully grown the maggot leaves it filthy, wet, breeding grounds and migrates to drier soil or sand to pupate.

c. *Pupa.* The pupae are dark, reddish brown, and about one-quarter inch long. Unlike the larvae or maggots, the pupae do not feed or move about. The pupal stage lasts from 4 to 7 days.

d. *Adult.* From the pupal stage the fly emerges as a full-grown adult and crawls upward through the loose soil to the surface. Soon after its emergence its wings dry and harden. The fly is now ready to start feeding on filth and bring disease germs to our food. The female usually starts laying eggs, about 48 hours after hatching from the pupa. Under favorable conditions of food, temperature, and humidity, the fly's entire life cycle, from egg to egg, averages 15 days. During the summer, adult flies may live about 30 days.

### 183. Habits

Since their mouthparts are fitted only for sponging up liquids, houseflies cannot take up solid food. To dissolve solid food, the fly vomits some of its stomach contents onto the food and then sponges it up. By this method flies sample all manner of filth and waste matter and may easily swallow disease organisms or pick them up on their feet and bodies. Knowledge of the characteristics and habits common to houseflies, described below, will serve as a useful guide to effective fly control.

a. Houseflies breed in animal manure, human waste, and decaying vegetable or other organic matter.

b. Suitable food, moisture, and warmth are required by growing larvae or maggots.

c. Temperature most favorable for breeding is from 80° to 90° F.

- d.* Larvae move from the breeding material to a drier place to pupate.
- e.* Adult flies are attracted by food odors.
- f.* Flies tend to rest on vertical surfaces and hanging objects.
- g.* In the temperate areas of the world, flies are most abundant in late summer and early fall.
- h.* In warm climates, breeding may take place throughout the year.

### Section III. CONTROL MEASURES

#### 184. General

Flies may be controlled through proper sanitation by eliminating their breeding areas; by screening living quarters; and by the use of chemicals to kill both adults and larvae. Elimination of breeding is the most effective part of a fly control program. Sanitation, therefore, is a "must" if the program is to be successful.

#### 185. Control of Breeding Places

To eliminate breeding places of flies, all human waste, animal manure, and garbage must be covered, disposed of, or treated promptly and effectively. In any fly control program, strict observance of the following procedures is most important:

- a.* Have garbage picked up regularly.
- b.* Keep garbage cans clean and covered with tightly fitting lids.
- c.* Keep ground areas around garbage racks free of refuse and properly drained.
- d.* Clean grease traps regularly.

e. Protect foods by screening or refrigeration, as indicated.

f. Clean latrines daily.

g. Operate waste disposal facilities properly to prevent fly breeding.

### **186. Field Waste Disposal**

In the field, waste disposal is always a problem. This subject is covered in detail in chapter 5.

### **187. Screening**

All food-handling establishments, hospitals, post exchange buildings, latrines and living quarters should be protected by screening. These screens should be constructed of 18 mesh wire to bar mosquitoes as well as flies. Screens must be kept in good repair, and doors should fit snugly, be self-closing, and open outwardly. Garbage stands, however, will not be screened or otherwise enclosed as this would make them difficult to clean.

### **188. Chemical Application**

While the use of chemicals is an important aid to sanitary practices, it should never be adopted as a substitute for sanitation in the control of flies. In places where sanitation is difficult, chemicals can be used to control fly breeding or to prevent new adults from leaving their breeding places. Unless they are properly maintained, areas surrounding garbage platforms, as well as stables and outside latrines, make good fly-breeding grounds. The use of chemical applications at these sites is additional insurance against fly buildup. Two types of insecticide spray are used for fly control:

*a. Space Spray.* The aerosol bomb may be used for quick knockdown and kill and, when correctly applied, is very effective. During application of the spray, windows and doors should be closed and remain closed for from 30 to 60 minutes after the application. In mess halls, application at the rate of 7 seconds per thousand cubic feet should be made from one-half to one hour before serving meals. Since it does not have sufficient strength to deposit a reliable residue of toxic materials, the aerosol should never be applied to surfaces as a residual spray.

*b. Residual Sprays.* Insecticide, 5 percent DDT, liquid, residual spray or other approved insecticides may be used as residual sprays for control of adult flies. Residual sprays are effective for long periods of time. Usually, it requires from one-half to four hours' exposure to this residue before a fly is killed. In spraying the interior of buildings, special attention should be given to areas where flies usually rest, such as ceilings, corners, table legs, and fixtures. Doors, screens, porches, and the outside areas around buildings to which flies are attracted should be sprayed with a residual spray. Most of the flies not found in buildings will be found resting in those areas. For shrubbery, trees, and grass, use emulsifiable concentrate or water dispersible powder (par. 151b and c). These preparations will not harm vegetation as will the oil formulations described above. Since larvae are usually below the surface of breeding media, it is difficult to reach them with chemicals. Effective results have been obtained when the soil was saturated with lindane and

dieldrin. The most effective way to control fly larvae is to destroy or remove their breeding area.

*c. Fly Baits.* Where houseflies have developed resistance to DDT and other chlorinated hydrocarbon insecticides, effective control can be obtained by using baits containing an organic phosphorous insecticide such as malathion. These baits are prepared by trained personnel and usually consist of cornmeal or sugar and malathion. The prepared bait is furnished to units and is sprinkled in mess halls, barracks, around garbage racks and at other locations where flies congregate, at a rate of one ounce per 300 square feet. Some of the organic phosphorous insecticides are highly toxic to humans. Therefore only approved formulations will be used at Army installations.

### 189. Swatting

Swatting is an excellent method of destroying flies which have entered a screened building. If the shades are drawn on most of the windows, flies will congregate near the light of the unshaded windows where they can be knocked down quickly. No mess hall should be without several conveniently placed fly swatters.

### 190. Flytraps

Before modern fly sprays were available for issue, flytraps were used extensively for fly control by the Army. With an effective sanitation program and the proper use of sprays, flytraps are no longer authorized. They can, however, be used to advantage in conducting surveys to determine the species of flies present in a given area. A fly-

trap of simple construction and efficient operation is shown in figure 46.

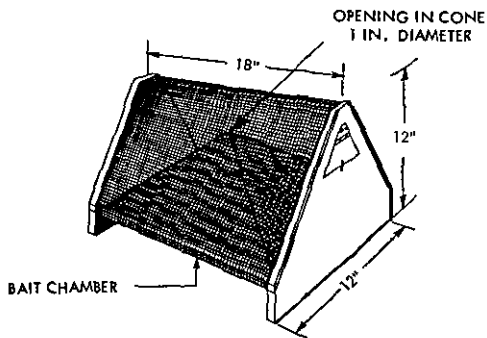

*Figure 46. Flytrap (easily constructed, screen wire placed around frame and holes punched in the inverted V).*



# CHAPTER 11

## ARACHNID-BORNE (TICKS, MITES, SPIDERS) DISEASES AND THEIR CONTROL

---

### Section I. INTRODUCTION

#### 191. General

Ticks, mites, spiders, and scorpions are commonly referred to as insects. Technically, however, they belong to the class Arachnida, whereas true insects belong to the class Insecta. Arachnids differ from insects in their body structure as follows:

| <i>Arachnida</i>                                 | <i>Insecta</i>                              |
|--|---|
| (Ticks, Mites, Spiders,<br>Scorpions)            | (Flies, Fleas, Mosquitoes,<br>etc.)         |
| Antennae absent                                  | Antennae present                            |
| Four pairs of legs in adult<br>stage.            | Three pairs of legs in<br>adult stage.      |
| Body divided into one or<br>two parts (fig. 47). | Body divided into three<br>parts (fig. 31). |

#### 192. Ticks

Ticks occur most commonly in the tropic, subtropic, and temperate zones; but they have also been collected in the arctic and subarctic zones. They are divided into two groups: hard ticks and soft ticks. The hard tick has a hard shield on its back and the mouthparts can be seen from above (fig. 47). The soft tick has no shield over its back, its body is soft, and the mouthparts can be seen only from below (fig. 48).

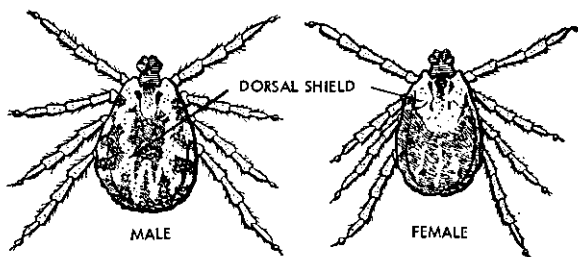

Figure 47. Adult hard ticks (note dorsal shield and visible mouthparts).

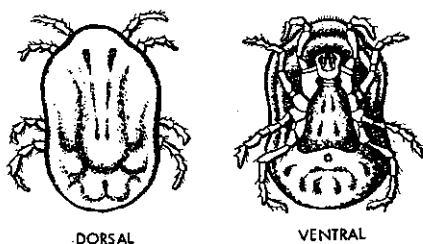

Figure 48. Adult soft ticks (note the absence of visible mouthparts and dorsal shield when viewed dorsally).

a. *Tick-Borne Diseases.* Ticks are the vectors and reservoirs of several diseases. Hard ticks are known to transmit Rocky Mountain spotted fever and other typhus-like fevers, tularemia (rabbit fever), and Q fever. Moreover, the females of certain species are capable of causing a condition known as tick paralysis. Several species of soft ticks transmit the disease organism of relapsing fever. When tick bites are numerous the skin may become badly inflamed and infected.

b. *Methods of Transmission.* The tick becomes infected with the disease organism when it feeds on an infected animal. It can then transmit this disease to man if it feeds on him later. Both

the hard and the soft ticks can also pass the germs of several diseases on to their offspring through the egg, so that future generations of ticks are already infected when they hatch from the egg.

## Section II. CHARACTERISTICS AND HABITS OF TICKS

### 193. Life Cycle

The life cycle of ticks is not the same for all species. Some species have a one-host cycle; that is, the tick does not leave its host until it reaches the adult stage. Others have several hosts; the tick will feed on one animal, then drop off to enter the next stage of its life cycle and later attack another animal to obtain a blood meal. The life cycle of a tick consists of four stages: egg, larva (seed ticks), nymph, and adult (fig. 49). Below is shown the life cycle of the Rocky Mountain spotted fever tick—*Dermacentor andersoni*.

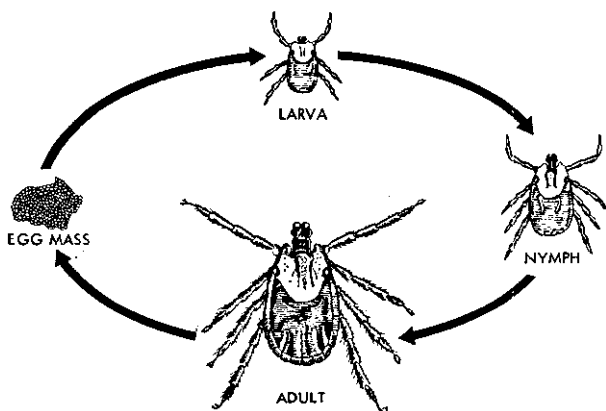

Figure 49. Life cycle of ticks (note 6-legged larva).

a. *Eggs*. The fully engorged female deposits eggs on the ground in masses of from 100 to 10,000 or more. The incubation period requires about 35 days.

b. *Larvae (Seed Ticks)*. The larvae have six legs. The young larvae climb upon grass and brush and await the passing of animals. The disturbance caused by animal or man moving through the area causes the seed tick to reach out with its forelegs. Should an animal or man brush by the vegetation on which the larval or "seed tick" is waiting, the tick grabs at the fur or the clothing and thus transfers itself to the host. Here it feeds for a few days and then drops off to molt to its next form, called nymph.

c. *Nymphs*. The six-legged larval forms transform into eight-legged nymphal forms, which become active and climb upon plants and vegetation; if fortunate, they become attached to some animal on which they will feed for approximately one week. After engorgement, they drop to the ground. During the next two months they change into the adult stage. Usually the hot weather prevents the adults from seeking a new host and they remain inactive until the following spring. If the nymphs have not found a host during the summer they may survive another season before feeding.

d. *Adults*. The adults, both male and female, become active in the early spring when the weather turns warm. They also climb upon vegetation and await the passing of animals. Large animals, including man, are the usual hosts of adult ticks. The males and females mate on the

animal; and after feeding for a week or two, the females drop to the ground, seek out a crevice in rocks or under debris, digest their blood meal, deposit their eggs, and die. It usually requires two years to complete a tick's life cycle, but it may last as long as three or four years.

### Section III. CONTROL OF TICKS

#### 194. General

Out in the open, ticks are very difficult to control with insecticides. A certain amount of local control can be accomplished by clearing away brush and vegetation and keeping animals out of the area. Within buildings, insecticide sprays and dusts have been used successfully for the control of dog ticks. Personal protective measures, such as the use of chemical repellents and protective clothing, are very effective.

#### 195. Control of Breeding Areas

The control of large breeding areas involves the application of chemicals to the areas in order to destroy all stages of the ticks, as well as the control or removal of animal hosts. Cattle that may be grazing in these areas should be dipped periodically in insecticidal solutions. Area control of ticks is a major operation and should be confined to small bivouac areas or camp sites.

#### 196. Insecticides

Dieldrin or lindane applied at a rate of 0.5 to 1.0 pounds per acre is preferred for area control of ticks. DDT or chlordane applied at a rate of 1 to 2 pounds per acre may also be used. The degree of

control depends upon the extent of coverage and penetration of tick-infested litter, with either large quantities of liquid applied as coarse sprays or smaller quantities applied as fine mist sprays from close range. Drifted sprays are unsatisfactory. Effective control of ticks depends on knowledge of the characteristics of the species concerned.

### **197. Preventive Measures**

Since it usually is impracticable to control ticks in the field, effort should be concentrated on keeping ticks off the body and removing them before they become attached.

### **198. Repellents**

Insect repellent can be applied to the clothing below the knees and around the belt line. A narrow band about one-half inch wide may be applied along both the inside and outside of all openings in the clothing, neck and cuffs of shirts, waist, fly, and cuff of trousers, and socks above shoes. For details pertaining to applications to the skin see paragraph 152*d*. Clothing may also be treated by impregnation of the entire uniform (par. 201*b*).

### **199. Removal of Ticks**

It may require some time for ticks to infect a person after they have attached themselves to the body. Persons in tick-infested areas should examine their bodies frequently so that ticks may be removed before they have been attached to the body for as long as 2 hours. This will often prevent the transmission of disease. To remove a tick

attached to the skin, be care not to crush it or to leave the mouthparts imbedded in the skin. Crushing it with the fingers may cause the fingers to become contaminated with disease agents. Ticks may be removed by careful pulling with small forceps, although they may detach themselves if insect repellent or heat is applied. After removal, the best method of destroying ticks is by burning. The bite wounds should be treated with a suitable antiseptic.

#### Section IV. MITES AND CHIGGERS

##### 200. General

Some mites are blood feeders and attack both warm- and cold-blooded animals. Other mites are free-living in the soil and on plants and do not attack man or animal. Mites are distributed widely throughout the world and are found in practically all climates.

*a. Diseases Transmitted by Adult Mites.* The disease rickettsialpox, which at the present time is only known to occur in the United States, is transmitted to man by a rodent mite. Several species of mites found frequently on rats and mice are involved in the transmission of other diseases. The itch mite burrows and lives in the skin of man, causing the disease known as scabies (the itch). Related species of mites cause similar skin conditions among animals such as dogs, horses, and hogs.

*b. Control of Adult Mites.* The control of adult mites varies with their types. Normally, the control of mice and rat hosts will also effect con-

trol of the mites that are associated with them. Dusting rat burrows and runways with an insecticide powder may help to control the mite population on the rodents. The most permanent control method is to eradicate the rodent hosts, either by poisoning or by trapping (ch. 14).

- (1) *Scabies*. This disease, known also as "seven-year itch," is a contagious skin infestation caused by a tiny itch mite (fig. 50).
- (2) Scabies mites in the skin can be killed by applying lindane ointment. Methyl bromide gas kills all stages of mites. The personal clothing and bedding of infested

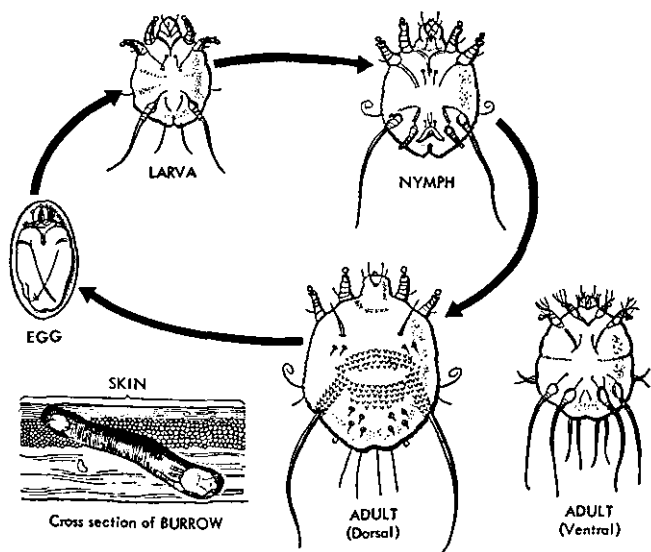

Figure 50. Life cycle of scabies mite and cross section of a typical itch mite burrow.



personnel may be fumigated in a de-lousing bag with methyl bromide. Ordinary laundering and cleaning will destroy mites in clothing.

## 201. Chiggers (Larval or Immature Mites)

The "chigger" is in reality an immature mite which has only three pairs of legs (fig. 51). Larval mites in the United States are not known to transmit disease, but because of the itching caused

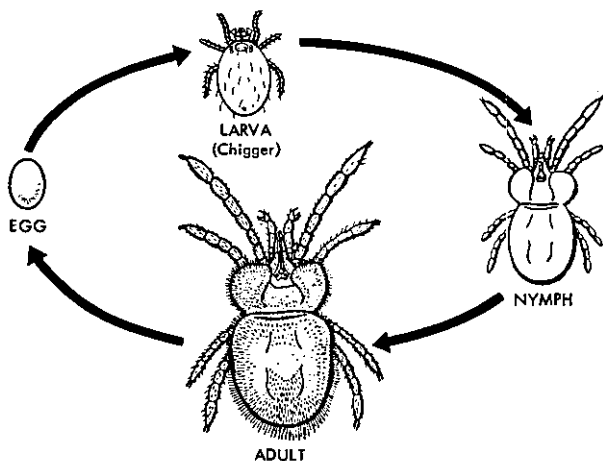

Figure 51. Life cycle of mites (note the 6-legged larva or chigger).

by their bite they are most annoying. Persons not accustomed to chigger bites often suffer more from them than do those who have lived for some time in areas where chiggers are abundant.

a. *Diseases Transmitted by Chiggers (Larval Mites)*. Larvae of certain oriental mites, often

called the kedani mite, transmit a severe type of fever known as scrub typhus, Japanese river fever, tsutsugamushi, or mite-borne typhus. In Japan, the chigger vector is found along rivers and flooded areas, especially during the hemp harvesting season, and in the scrub brush areas of Mount Fuji. In the tropics the chigger is very common in jungle grass, low brush, and other uncultivated areas.

*b. Control Measures.* Area control of mites is difficult and in many cases impracticable. The number of mites in a particular area may be reduced to some extent by the use of sprays of dieldrin at the rate of 1 lb. per acre or lindane, 0.4 lbs. per acre. In permanent or semipermanent camps located in areas where scrub typhus is prevalent it may be necessary to remove all surrounding growth with bulldozers, to burn the collected debris, and to place tents two or three feet off the ground. Control of rodents is also helpful. Protection from mites through the use of protective clothing and repellents is the most useful method of preventing scrub typhus. Mite-infested areas should, if possible, be avoided. If these areas cannot be avoided, men should fasten their trousers snugly at the ankles, roll their sleeves down, button their collars, and use skin and clothing repellent in the following manner:

- (1) *Insect repellent.* The repellent issued by the Quartermaster Corps for protection against mosquitoes is also effective against chiggers (par. 153*d*). It should be applied to the exposed skin and as a

moist band, 1/2-inch wide, on the inside of the trouser bottoms and waist band, inside the cuffs of the sleeves, and between the buttoned surfaces of the shirt front. Chiggers will not cross these protective bands of repellent, and a single application will furnish protection from chiggers for as long as two weeks. A better method, however, is to treat the entire uniform with the emulsion discussed below.

- (2) *Clothing impregnants.* Repellent, insect, clothing treatment. Personnel going into an area which is suspected of being endemic for scrub typhus, or of being heavily infested with mites, should have their clothing impregnated with this repellent. The material is diluted with water before use. The clothing, including jacket, trousers, and cap, should be immersed in this emulsion, then wrung out to remove excess fluid, and allowed to dry. Socks should be impregnated when the trousers are not tucked inside boots. Impregnation instructions are printed on each can of the repellent. In the absence of unit impregnation facilities, the diluted material may be issued to individual personnel at the rate of three pints per person. The helmet can be used as a container and the articles of clothing dipped individually.

## Section V. BLACK WIDOW SPIDER

### 202. General

Very few spiders are capable of inflicting bites that are fatal to man. Several species, however, do inflict painful bites. The spider of greatest importance to the soldier is the black widow, also called hourglass spider, shoe-button spider, or pokomoo.

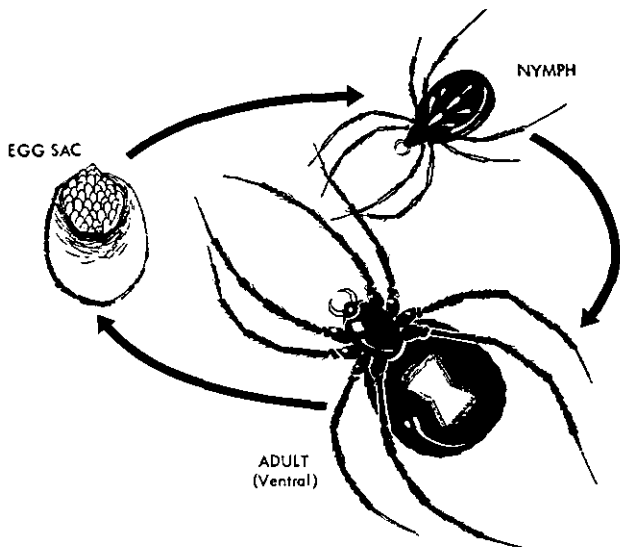

Figure 52. Life cycle of black widow spider.

*a. Characteristics and Habits.* The black widow spider (fig. 52) is found in practically all parts of the Western Hemisphere and can easily be identified by its jetblack color and the reddish hourglass-shaped figure that is found on the underside of its abdomen. It is found in grass,

shrubs, rock piles, outhouses, latrines, and similar locations. This spider is not aggressive and usually prefers to remain hidden. When it is molested, however, it will readily bite.

*b. Medical Importance.* The venom injected by the black widow spider affects the nervous system of the body, especially the nerves of the abdominal muscles. Ordinarily, the bite itself is not felt but two tiny red spots usually appear. A few minutes later severe pain is felt at the location of the bite and may last as long as 2 days before it subsides. The muscles of the abdomen frequently become stiff and board-like and there is severe abdominal pain.

*c. Control.* Whenever discovered, the spider and its web should be destroyed with a broom or stick. The egg sac which may be present in the web should not be overlooked, but special care must be taken when an egg sac is being removed because the female, when guarding her eggs, is apt to be quite aggressive and inclined to attack. As a rule, sprays of DDT-kerosene solution, lindane, chlordane, and dieldrin will give satisfactory control.

*d. Treatment.* The regular snakebite first aid treatment is of little or no value in the case of a black widow spider bite. The victim should be kept as quiet as possible and should receive the attention of a medical officer without delay. Ice packs should be placed around the region of the body where the bite occurred to keep the venom from spreading. Although the bite of a black widow spider is quite painful, death seldom results if proper treatment is administered in time.

## Section VI. SCORPIONS

### 203. General

Scorpions are easily recognized by their crab-like appearance and their long, segmented tail which ends in a sharp spine or stinger (fig. 53). Scorpions are found most commonly in warm climates. They prefer damp locations and are particularly active during the night. In the daytime they prefer to remain hidden under the bark of fallen logs and under rocks, woodpiles, floors of outbuildings, debris, sand, or loose dirt. Their diet consists of insects and spiders which they grasp with their pincers and kill with their stinger. Dampness and a supply of food seem to attract them to certain areas. Some houses may become infested, while adjacent houses remain free.

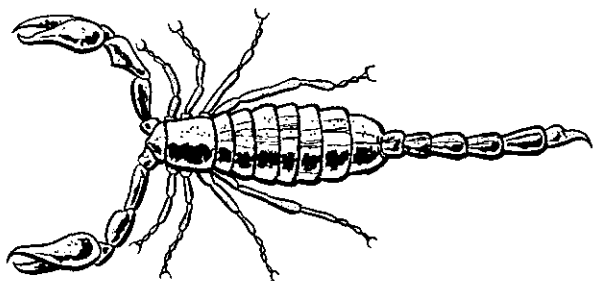

Figure 53. A typical scorpion.

a. *Medical Importance.* Scorpions are able to inflict painful stings, and in some cases they may even cause death. In Arizona, Mexico, and Egypt there are types of scorpions that are reported to have caused several deaths a year, but in most instances the victims were either young children or

aged adults. Many small varieties, however, are harmless since they are unable to penetrate the human skin with their stinger. All but a few of the scorpions found in the United States are capable only of causing a painful sting. Scorpions enter houses and have been known to crawl into closets, shoes, beds, or other areas during the night. Many a soldier has been stung in the toe as he put on his shoes in the morning.

*b. Treatment.* When stung by a scorpion on the face, neck, or genital organs, the victim should receive the immediate attention of a medical officer. First aid for an ordinary scorpion sting consists of applying a piece of ice to the site of the sting as soon as possible. While this has no effect on the poison itself, it does decrease the absorption of the venom by the body. If ice is not available, baking soda applied as a paste to the site of the bite often will relieve the pain.

*c. Control.* At the present time there is no satisfactory insecticide that will effectively kill or repel scorpions. Two percent chlordane has given fair results (par. 211b(1)). DDT residual spray in protected areas has been quite effective over a period of months on the inside of buildings, in closets, cupboards, cabinets, plumbing fixtures, and other areas where scorpions hide. On the outside of buildings a band extending around the house as far up as window sills may be treated, particular care being taken to saturate all cracks or crevices in and around the wall or window sill. Scorpions depend upon household insects for food; if these insects are kept to a minimum the scorpions will leave in search of food elsewhere.

## 204. Whip Scorpions

Whip scorpions are ferocious in appearance, but from a medical standpoint they are unimportant. They are of interest only because they closely resemble and may be confused with true scorpions. The distinguishing feature of whip scorpions is that they have no stinger at the end of their tail.



# CHAPTER 12

## FLEA-BORNE DISEASES AND THEIR CONTROL

---

### Section I. INTRODUCTION

#### 205. General

Fleas are of medical importance because they produce irritating bites and transmit serious diseases. The fleas which attack man live chiefly on cats, dogs, and rodents. When man is in close association with these animals, conditions are ideal for the occurrence of flea-borne diseases. In areas where rats and other rodents abound, the rat and flea problem demands particular attention (fig. 54).

*a. Flea-Borne Diseases.* Rodent fleas are responsible for the transmission of bubonic plague and endemic (murine) typhus. Various rodents, principally rats and ground squirrels, are sources of infection from which fleas pick up the disease organisms and transmit them to man. When the normal rodent hosts are unavailable, rodent fleas will readily attack man. Some fleas harbor the cyst stage of a small tapeworm and if accidentally swallowed by man they will cause tapeworms to develop in his digestive tract. Other fleas (chigoe or jigger flea) attack the bare feet, usually between the toes and on the soles of the feet, where they cause painful swelling and inflammation (fig. 55).

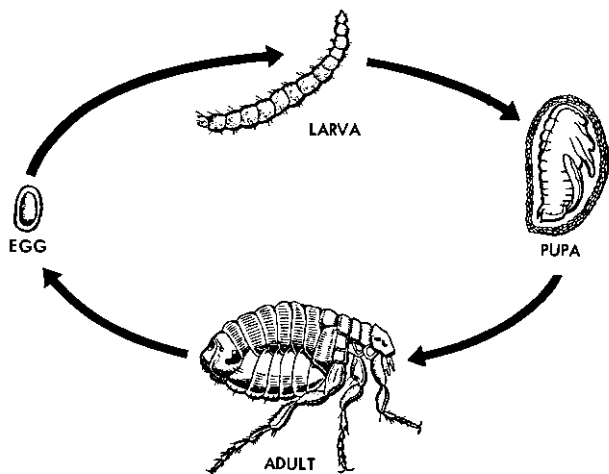

Figure 54. Life cycle of a flea.

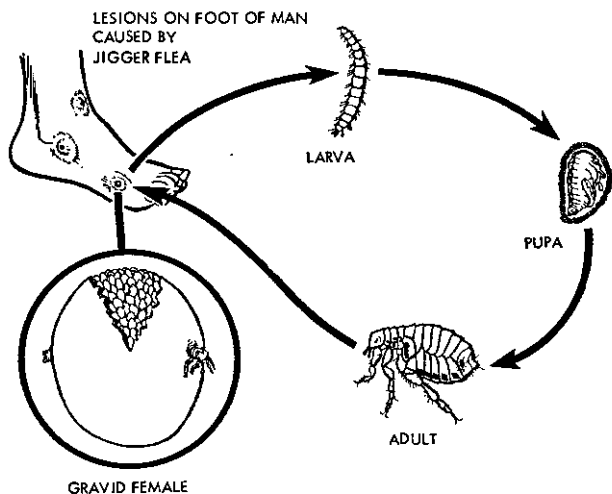

Figure 55. Life cycle of the jigger flea. (Insert shows the enlarged gravid female and typical lesions caused by the flea.)

*b. Method of Transmission.* In the case of plague, the flea feeds on a rodent which is infected with plague. The plague germs then multiply in the stomach of the flea. After a period of time a mass of blood and germs is formed which blocks the flea's digestive tract. Thereafter, when the flea attempts to feed, the blood meal cannot break through this obstruction but is forced back through the mouth by the struggle of the insect and is returned to the victim, carrying with it living plague germs from the flea's fore-gut. Plague germs are also passed in the feces of the flea and may enter the host if rubbed into skin abrasions at the site of the flea bite. Under certain conditions the organism may be coughed out from the lungs of pneumonic type cases and then breathed in by persons near the patient. The germs causing endemic typhus are transmitted in the feces and crushed bodies of fleas in the same manner as is louse-borne typhus.

## Section II. CHARACTERISTICS AND HABITS OF FLEAS

### 206. Life Cycle

Fleas go through four stages of development: egg, larva, pupa, and adult (fig. 54).

*a. Egg.* Flea eggs are small, glistening white, and are laid in the debris of rodent nests or in places where cats and dogs sleep. The adult female lays from 2 to 18 eggs at one time and during her life may lay 400 eggs or more. Depending upon temperature and humidity, the egg stage lasts from 2 to 12 days.

b. *Larva.* Flea larvae are tiny worm-like creatures. They feed in the debris of the nest of their hosts, such as rats, squirrels, cats, dogs, etc. The larval stage may last from 9 to 200 or more days, depending on temperature, humidity, and the availability of suitable food.

c. *Pupa.* Mature larvae spin cocoons and pupate inside of them. The pupal stage takes from seven days to over a year to complete. The length of time required to pupate depends upon temperature and humidity.

d. *Adult.* The wingless adult fleas are flattened from side to side and have strong, spiny legs which enable them to move rapidly among the hairs or feathers of their host and to jump great distances, (the human flea can jump as far as 13 inches). Their mouthparts are fitted for piercing the skin and sucking blood. Adult fleas are parasitic on warm-blooded animals.

e. *Habits.* Although fleas have certain host preferences, they will readily transfer the feed on different animals, including man. This makes them important in the transmission of disease from animal to man. Both male and female forms occur on the host, and eggs are deposited and fall off on the ground or into burrows, nests, or shelters. The adult females require a blood meal before egg laying.

### Section III. CONTROL MEASURES

#### 207. General

Fleas are controlled by applying insecticides either to the animal hosts or to the infested areas.

Insecticide powder is applied to animals; powder or liquid is applied to floors and basements. Powder is preferred, and it can be distributed more thoroughly than can a spray when treating rodent burrows.

*a.* In the control of the common dog and cat flea, lindane powder is more effective than is DDT (par. 170*c* and *d*). The powder is applied in a thin layer over the infested area. Infested animals should be dusted lightly. Animals which clean themselves by licking—such as cats and rabbits—should not be dusted with lindane or DDT. On such animals pyrethrum or rotenone powder should be used. In thatched huts and adobe structures the rate of dosage must be increased.

*b.* In dusting burrows and harbors for the control of rodent fleas, lindane or DDT powder (par. 170*b*) is very effective. It is applied with a dust gun to burrows and rodent runs in and about buildings. Special attention must be given to the spaces between walls and floors, beneath boxed-in shelves, and between the first floor and the ground. In a plague epidemic, dusting should always be accomplished before a rat-poisoning program is begun, since it is vital that the infected fleas be killed before they leave the animal host and attack man.

*c.* Individual protective measures should be used in flea-infested areas. This is especially important for those persons who are doing flea and rodent control work where plague and typhus are present. Clothing should be impregnated, particularly the socks and the lower parts of trousers. This may be done with the standard repellents described in chapter 11. Repellent should also be

applied to the hands and other exposed portions of the body. The sleeves should be kept rolled down and trousers bloused at all times.

#### **208. Control of Breeding Places**

Flea larvae feed upon organic matter in flea feces, rat feces, or other sources. In buildings containing rats or other animals, flea larvae will often be found in cracks and crevices of the floors. Good cleaning practices will do much to reduce the number of flea larvae. Applications of insecticide dust or spray to likely breeding places, such as floors of buildings, doghouses, rodent nests, etc., will control the breeding of fleas satisfactorily. Merely dusting the dog will not solve the problem. The flea eggs and larvae are in the debris about the areas where the animal rests. Unless these areas are cleaned up, reinfestation will take place.

## CHAPTER 13

# MISCELLANEOUS INSECTS AND INSECT-BORNE DISEASES AND THEIR CONTROL

---

### 209. General

There are many insects which, while not involved in disease transmission, are of medical importance because of their sting (such as bees and wasps) or because of their presence in large numbers (such as nonbiting ants and midges). This chapter deals with a selected number of insects which may not be involved in disease transmission, but which cause concern by their presence (such as bedbugs and roaches); and with certain others which are proved vectors of disease: for example, sandflies.

### 210. Bedbugs

*a. General.* Bedbugs survive wherever they can live in close association with man. As yet it has not been proved that bedbugs transmit any disease. In some persons their bite produces marked swellings and considerable irritation, while in others not the slightest inconvenience may be caused.

*b. Life Cycle.* Bedbugs pass through three stages in their development: egg, nymph, and adult (fig. 56). The nymphs and adults are blood-suckers.

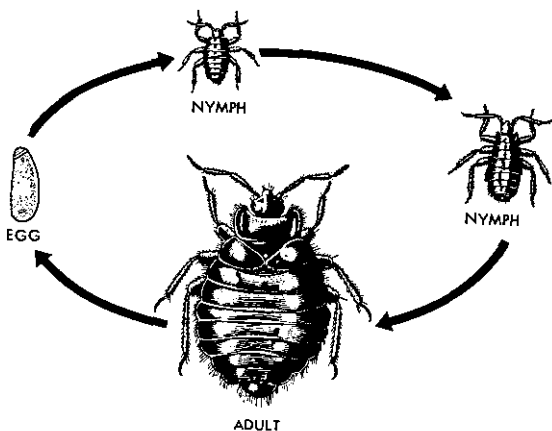

Figure 56. Life cycle of bedbug.

- (1) *Egg*. The female deposits eggs in batches of from 10 to 50, in convenient crevices in mattresses, bedsteads, and bedsprings, and in cracks of floors and walls. The eggs are yellowish white and visible to the naked eye. One female may lay as many as 500 eggs. Depending upon the temperature, the egg stage lasts from 7 to 30 days.
- (2) *Nymphs*. The nymphs look very much like the adult, except that they are smaller. The nymphal stage may last from 40 days to many months. The nymphs molt five times before reaching maturity, the average period between moltings being eight days. Ordinarily they take but one meal between molts.
- (3) *Adults*. The adults have flattened bodies



which permit them to crawl into narrow crevices. A nasty, pungent odor is noticeable where bedbugs are abundant. Adults may live up to four months without food. Under ordinary room temperature normally fed bedbugs may live as long as a year. A temperature of 100° F. will kill them.

*c. Habits.* Bedbugs feed at night. During the day they hide in cracks and crevices and often can be found in the seams of mattresses or in the bed-springs. Very active at night, bedbugs will travel considerable distances to attack a sleeping person. They are timid and will retreat to the nearest hiding place at the slightest disturbance.

*d. Control.* Bedbugs are easily controlled with chemicals. The general issue residual spray (par. 151a) is very effective. It is applied to walls, cracks, and crevices on the inside of buildings to a height of from five to six feet. Bedframes are sprayed particularly the undersides, joints, and cracks where bedbugs like to hide. The surplus spray should be allowed to fall on the wall behind the beds. Mattresses are sprayed on both sides and on the ends, seams, tufts, and crevices receiving special attention. For big jobs a three-man team is needed: one man to do the spraying, the other two to turn over each mattress and remove it after it has been sprayed. If no equipment for spraying is available, the solution may be applied with a paint brush. A slight moistening of the surface is all that is required. The insecticide acts slowly; but when the above procedures are followed practically all of the bedbugs will be dead within 24

hours. There should be no smoking or fire in the building during the spraying, and the barracks should be aired out for about four hours following the treatment. While doing the spraying, operating personnel should wear suitable masks, or respirators, and rubber gloves.

## 211. Roaches and Ants

*a. General.* It has not been proved that roaches and ants transmit diseases, but they may transport disease organisms on their bodies and feet and so contaminate food as they crawl over it. There are three stages in the life cycle of roaches: egg, nymph, and adult (fig. 57).

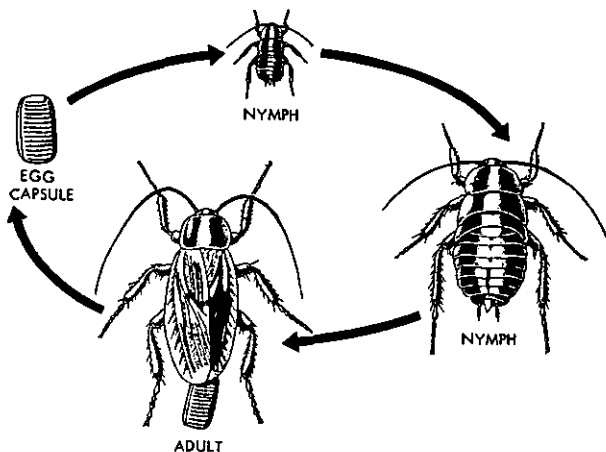

Figure 57. Life cycle of roach.

*b. Control Measures.* The first step in roach and ant control in mess halls and quarters is sanitation. Stored food should be kept in insect-proof

containers; garbage and food scraps should be removed daily. In the control of roaches, chlordane is more effective than is DDT.

(1) *Roaches*. Insecticide, roach and ant control, residual effect chlordane. This insecticide was formulated especially for the control of roaches and ants. Chlordane is highly toxic and should be used with caution. Residual applications should not cover the entire floor or wall surface of a room. Insecticide is applied within and underneath cabinet drawers, and around baseboards, cracks, and crevices where roaches usually rest and nest. A paint brush may be used for this purpose. This insecticide is a fumigant as well as a contact and stomach poison and should never be applied in a nursery or in young children's rooms; nor should it ever be stored in mess halls or in kitchens. Insecticide powders may be used to treat electrical switch boxes and areas difficult to reach with sprays. The use of an organic phosphorous insecticide such as malathion may be required to control roaches that have developed resistance to insecticides.

(2) *Ants*. The same material and the same sanitation methods that are used for the control of roaches are effective for the control of ants. The material is applied to nests, door sills, window sills, foundations, and other places where ants crawl. In buildings having a solid foundation an

application of the spray may be made around the entire building to form a barrier. Since oily preparations will cause burning of plants, a water suspension or emulsion of DDT, lindane or diel-drin is recommended for lawns and vegetation. The material is applied directly to the ant nest, covering a circular area of one yard or more. Continuous use of this material on lawns where new nests are made will eventually kill or drive the ants away.

## 212. Stableflies

*a. General.* The stablefly (fig. 58) also called biting housefly and dogfly, looks like a housefly but has piercing mouthparts and is a severe biter of man and animals. Like the housefly, it has four

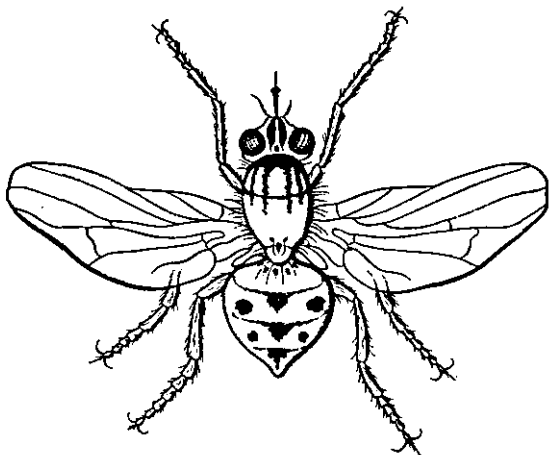

Figure 58. The common stablefly.

stages of development in its life history. Along coastal areas, where it breeds in sea grass washed up on sheltered beaches along the coast, it is often a very serious pest. Inland, the stablefly breeds in barnyard manures that contain large quantities of decaying hay, in waste feed, in litter beneath feeding troughs, under piled hay or peanut litter left in the fields, and in strippings of celery around celery-washing plants. Stableflies are best controlled by treating their breeding places with DDT or other recommended insecticides. Residual applications of 5 percent DDT spray on the exterior and interior wall surfaces of buildings and on screens will kill adult stableflies. Spreading manure and litter before it becomes infested and in such a way that it dries quickly will also prevent flybreeding.

*b. Use of Repellents.* Insect repellent provides effective protection for man or animals against the bites of stableflies. It may be applied to clothing as a fine spray mist or it may be applied from the 2-ounce bottle. It should also be applied to the face, neck, hands, and ankles, just as for mosquitoes.

### 213. Eye Gnats

*a. General.* Gnats are small flies which crawl about the nose, mouth, and eyes and are annoying to both man and livestock. Gnats feed readily on serum exuding from wounds or lacerated surfaces and may be responsible for spreading serious eye infections. They have a wide distribution and are most common in the milder climates.

*b. Control.* Breeding of gnats can be con-

trolled by the proper disposal of human wastes and by plowing and exposing infested soil to sun and air. Drying infested soil is very important in the control of breeding places of gnats. Jar traps will help to reduce the gnat nuisance around camps and buildings, but their value as a practical means of control is questionable. These traps consist of a  $\frac{1}{2}$ -gallon glass jar fitted with very fine (60- to 80-in. mesh) screenwire cones (fig. 59). The jars are laid on their sides in the forks of trees or in other shady places. Bait inside the jar consists of a cube of liver, about one inch square, with a small amount of water added to keep the liver from drying out. Control of gnats by chemicals is impracticable, but some relief may be obtained by fogging or misting the area with special power equipment. The repellent recommended for mosquitoes also affords protection from gnats (par. 152*d*).

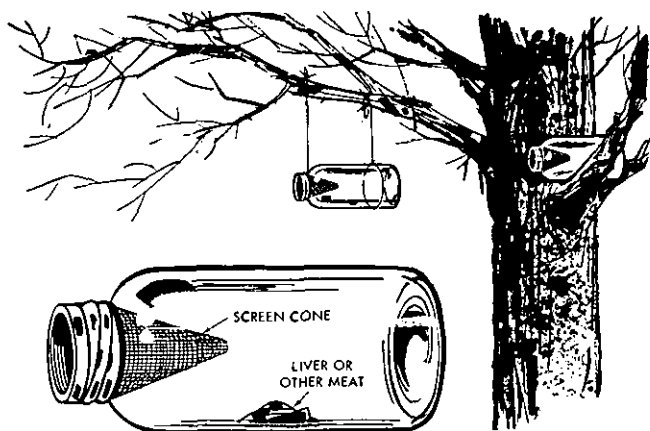

*Figure 59. Jar trap for eye gnats.*

## 214. Biting Midges

a. *Sandflies (Phlebotomus Species.)* *Phlebotomus flies* (fig. 60) resemble small gnats and are common in many warm countries, although they are rare in the United States and in Australia.

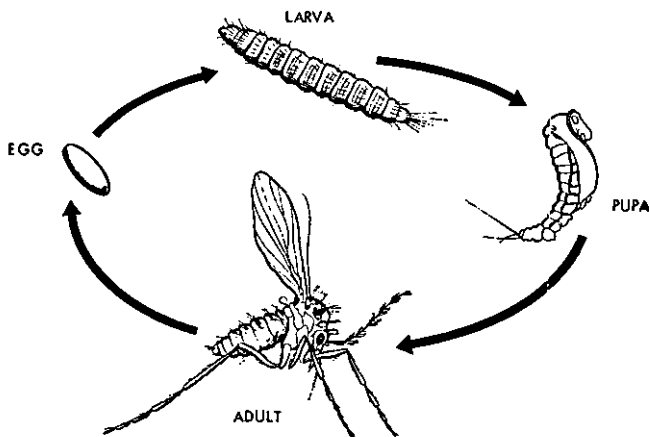

Figure 60. Life cycle of *Phlebotomus* (sandflies).

b. *Diseases Transmitted.* The *Phlebotomus flies*, or sandflies, transmit sandfly fever (papataci fever) a disease present in the coastal regions of the Mediterranean, South China, India, and Ceylon. They may also transmit a form of oriental sore as well as serious diseases known as kala-azar and Oroya fever.

c. *Habits.* Sandflies are active at night, in the evening, and at dawn; they usually avoid wind, sun, and full daylight but are attracted to artificial light. They travel in short hops from their breeding areas but rarely migrate farther than 50

yards. In buildings, sandflies seldom travel above the first floor. They attack man at the wrist, ankles, or any exposed part of the body, and will readily bite through thin socks. Their bite is painful and may result in marked irritation. They breed in dark places, caves, crevices, stone embankments, crumbling ruins, earth fissures, and stony rubble. Although the larvae require damp breeding media, too much moisture will kill them.

*d. Control.* Sandflies are very sensitive to DDT and other residual insecticides. In areas where there has been extensive residual spraying against mosquitoes for the control of malaria, sandflies likewise have been eliminated. Their habit of frequenting only the lower floor of buildings can sometimes be used to advantage by moving personnel to upper floor levels. Repellents, also, give protection against attacks by this pest.

- (1) *Insecticides.* All of the DDT formulations are effective against sandflies. Applications of residual spray are made to the screens and inside of buildings. Whenever possible, the area within a radius of from 50 to 100 yards should be cleared, smoothed, and sprayed with residual spray. Inside of sleeping quarters these pests may be controlled by the use of space sprays and residual sprays.
- (2) *Bednets.* In heavily infested areas, sleeping nets of fine mesh (0.0334-inch) may have to be used.
- (3) *Repellent.* The regular use of repellent has proved an effective means of preventing sandfly fever. Insect repellent



should be applied after sundown to exposed parts of the body. One application should be made at sundown and another upon retiring. Each application will afford protection against sandflies for from four to six hours.

- (4) *Protective clothing.* Long sleeves and long trousers will give some protection, especially after sundown.

## 215. Punkies

Various species of culicoides commonly called punkies, no-see-ums, and biting midges (fig. 61).

a. *General.* These are small, biting midges (from 1 to 3 mm. in length) which are extremely annoying and can pass through the mesh of ordinary window screens. They are commonly found in the tropics and subtropics and in the arctic dur-

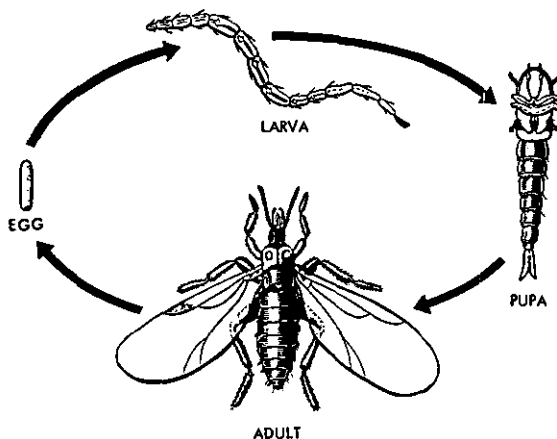

Figure 61. *Life cycle of Culicoides. (Biting midges, punkies, no-see-ums.)*

ing the short summer months. Some species breed in salt marshes where the larvae feed upon dead crabs and small fish left in wet soil. Other species breed in rot-holes of trees, and the larvae feed upon decaying insects usually present in those locations. When the adults emerge they are attracted to light and will feed upon warm-blooded animals.

*b. Control.*

(1) *Screening.* Punkies, like *Phlebotomus flies*, are so small that only a fine mesh (0.0334-inch) can keep them out. Nets with suitably small mesh usually are furnished by the Quartermaster Corps in areas where such insects are found. Ordinary screening can be made midge-proof by frequent painting with insecticide, spray, DDT, residual effect.

(2) *Insecticides and repellents.* Use as for mosquitoes (par. 152*d*).

**216. Blackflies (Simulium Species)**

*a. General.* Blackflies (also called buffalo gnats) are larger than punkies—from 1 to 5 mm. (fig. 62). Their common name is derived from their characteristic humpback appearance. They are particularly abundant in the north temperate and sub-arctic zones and often appear in great swarms during the late spring and early summer in hilly sections where swiftly flowing streams provide well-aerated water for larval development.

*b. Life Cycle.* Blackflies pass through four stages in their life cycle: egg, larva, pupa, and adult.

- (1) *Egg*. The adult female deposits its eggs at the water line of aquatic plants, logs, and rocks, usually in swift-flowing streams, in masses of from 300 to 500. Breeding may also occur in roadside ditches or in more slowly running streams. Hatching requires from 5 to 30 days, depending on the temperature.
- (2) *Larva*. The emerged larvae are cylindrical and, when fully matured, are from 10 to 15 mm. in length. They attach themselves to objects in the stream and feed on small Crustacea, Protozoa, and Algae. The larval period lasts from 3 to 10 weeks. At the end of the larval period they spin a basket-like cocoon in which pupation takes place. These cocoons are attached to rocks or other objects in shallow water.

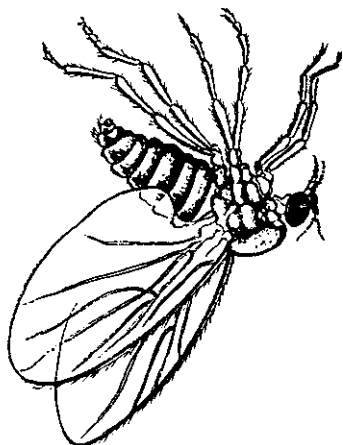

Figure 62. Adult *Simulium* species (Blackfly).

- (3) *Pupa.* In some species the pupal period is short—not more than five or six days; in others it may last from three to five weeks.
- (4) *Adult.* The adults emerge and seek a blood meal. They may be found long distances away from their breeding area, apparently seeking a host. Their life history from egg to adult ranges from two to four months.

*c. Medical Importance.* The bite of a blackfly is very painful and irritating. All exposed parts of the body are subject to attack. The extreme pain, intense itching, and the resultant local swelling with occasional severe complications indicate the presence of an active venom. Animals often die from the bites of these flies. The most important disease transmitted by blackflies is onchocerciasis—a disease of Central America and Africa.

*d. Control.* Control of blackflies is aimed at the control of breeding. Since these flies do not readily enter buildings, control methods are directed outdoors.

- (1) *Insecticides.* Formulations of DDT are quite effective against the larval stage in streams. They may be applied with both aerial and ground equipment. Airplane spray, 20 percent DDT at the rate of 0.3 pound DDT per acre is applied by aircraft. DDT emulsion concentrates and oil solutions are applied by hand, with sprayers, at the rate of 0.5 parts per million in the stream water. The streams are treated at points about one mile apart.

The over-wintering larvae are most difficult to kill than are the later summer generation. Insecticide should be applied after the ice melts in the spring and before the larvae start to pupate. Additional applications may be required later in the season.

- (a) If blackflies are present inside of tents or buildings, the aerosol bomb can be used against them.
- (b) Routine residual applications made in tents or buildings for the control of mosquitoes will also control blackflies.
- (2) *Screening.* Although blackflies are larger than the *Phlebotomus* (sandfly) they are small enough to enter ordinary 18-mesh screen. Painting the screens with DDT residual spray usually will keep these flies out.
- (3) *Repellents.* Applications of insect repellent to face, neck, and hands, as used for mosquitoes, will repel these flies for about seven or eight hours (par. 152d).

## 217. Kissing Bugs (*Triatoma*)

a. *General.* Bugs of this species have been found infected with organism that causes Chagas' disease in man. Chagas' disease causes a high mortality in certain sections of South America, especially in Brazil. The infection occurs in natural reservoir of animals such as armadillos, opossums, house mice, rats, bats, cats, dogs, and squirrels.

b. *Control.* Spraying of sleeping quarters with DDT and chlordane is effective in preventing

infestation. Cleaning up of litter used by bugs and rodents for harborage will help in the control of these insects.

# CHAPTER 14

## RODENT-BORNE DISEASES AND THEIR CONTROL

---

### Section I. INTRODUCTION

#### 218. General

Rodents are classified under the animal order of "Rodentia." Group characteristics are the chisel-like incisor teeth, the absence of canine teeth, and the wide space separating the incisors from the cheek teeth. Some of the common animals in this order are squirrels, marmots, gophers, beavers, domestic rats, mice, porcupines, and ground hogs. Only the domestic rats found in the United States which live in close association with man—the Norway rat and the roof rat—are considered in this manual.

#### 219. Economic Importance

Rats contaminate and destroy food supplies, damage buildings, and cause fires by gnawing the insulation of electric wires and conduits. Based on the estimate that there are as many rats in the United States as there are people, and that each rat contaminates, consumes, or otherwise destroys at least three dollars' worth of food per year, the annual cost of supporting the rat population of the United States approximates \$500,000,000.00. This does not include the cost of hospitalization, of

medical care, and of productive time lost resulting from the rat-borne diseases of man.

## 220. Rodents as Agents of Disease Transmission

Rodents are the reservoirs of several human diseases. Among the rodent-borne diseases, plague ranks first in importance. Other important diseases are endemic typhus or murine typhus; leptospirosis; Rocky Mountain spotted fever; scrub typhus (tsutsugamushi fever; Japanese river fever); tularemia (rabbit fever); and rat-bite fever. Rats also harbor parasitic infections such as trichinosis and tape worm.

## 221. Classification

Two species of domestic rats live in close association with man. They are the Norway rat, *Rattus norvegicus* and the roof rat, *Rattus rattus*.

a. *Norway Rat*. The Norway rat (fig. 63) has many common names, such as brown rat, wharf rat, gray rat, domestic rat, and house rat. It is the largest and most prevalent rat in the United States. A full-grown specimen usually weighs from 10 to 17 ounces or more. Its color varies from reddish- or grayish-brown to black on the back-and-white sides. Other characteristics are: tail shorter than the body; thick body; short head with small, inconspicuous ears.

b. *Roof Rat*. The roof rat (fig. 63) is relatively small. Full-grown specimens rarely weigh over eight ounces. Its coloring varies greatly, ranging from an over-all black to tawny-black with a grayish-white belly. The tail is longer than the body; it



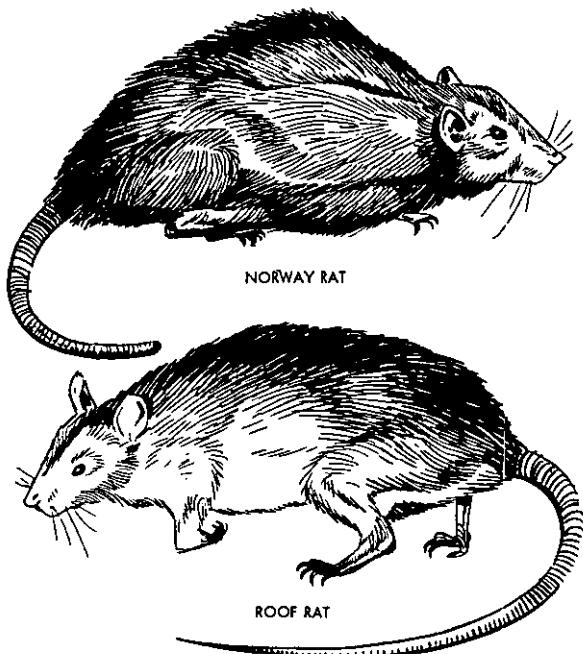

Figure 63. Two common domestic rodents.

has a narrow, slender head and large, conspicuous ears.

## 222. Life Cycle and Habits

a. *General.* The life cycle of domestic rats depends to a large extent on the climate and on the availability of food and shelter. The average life expectancy of a rat is about  $2\frac{1}{2}$  years. The gestation period averages 25 days and litters usually contain from 6 to 14 young. In the colder regions rats may produce from three to five litters per year while in the warmer regions they may pro-

duce six or more litters annually. All rodents adapt their diet to foods common to the area inhabited. Rats generally forage for food and water at night. They prefer to travel close to buildings or walls, and they have no aversion to entering and swimming in water. Rat behavior is influenced by maternal instinct, sex, curiosity, hunger, and thirst. The control of rodents is based mostly on their instinctive behavior in response to hunger and thirst.

*b. Norway Rat.* The Norway rat likes to live on the lower floor and basements of buildings, on wharves, and in sewers. It burrows into the earth, into embankments, and inside buildings which have earth floors. It will nest in double walls, between floors, and in accumulated piles of rubbish and wood.

*c. Roof Rat.* The roof rat prefers to live above ground, but it does not have any aversion to entering burrows or lower floors for protection. Roof rats are agile climbers and acrobats. They can travel from building to building and cross streets on utility cables. Normally, they inhabit the upper stories of buildings and will build nests in palm trees and in vines which cling to buildings. They can climb any wall that is constructed of material which affords a toehold, such as rough concrete or brick. Where food is available they will nest and breed, remaining above the first floor of buildings most of the time. The roof rat is the common rat of ships and is believed to be responsible for spreading the great plague epidemics of antiquity throughout the world.

## 223. Diseases Associated with Rodents

*a. Plague.* Plague ranks first in importance among rodent-borne diseases. It is found world-wide although not evenly scattered. Primarily a disease of rats and of other wild rodents, plague may be transmitted to man by the bite or the feces of a flea which has previously fed on an infected rodent. Control of plague is accomplished through the control of rodent fleas with the use of various insecticides which are discussed in chapter 12.

*b. Endemic Typhus.* Endemic typhus or murine typhus is transmitted to man by the feces of rat fleas. It is common in the southern and southeastern parts of the United States but is also found in many other parts of the world. This disease is usually milder than the epidemic typhus transmitted from man to man by the body louse.

*c. Leptospirosis.* Leptospirosis is caused by contact with urine or the feces of an infected rat or other animal. It is widely distributed throughout the world and may be contracted through the skin or by the consumption of food which has been contaminated by rats. In recent years, hogs, dogs, and cattle also have been known to spread these germs.

*d. Rocky Mountain Spotted Fever.* Rodents and other animals are the natural reservoirs of this disease. It is transmitted to man by infected ticks.

*e. Scrub Typhus.* Also called tsutsugamushi fever or Japanese river fever, this disease is transmitted by a larval mite which normally is parasitic on rodents (par. 201a).

f. *Tularemia*. This is a serious disease which may be contracted from the handling of infected rabbits or other rodents or from the bite of ticks or deerflies. It is widely distributed throughout the United States and has also been reported in Russia, Japan, Central Europe, Scandinavia, and Canada.

g. *Salmonellosis*. This is one form of food poisoning. Its germs may come from infected rats and mice, and it may be transmitted to man by food which has been contaminated with rat feces and urine.

h. *Trichinosis*. This is a disease of rats and pigs. Man becomes infected through the consumption of infected pork which has not been cooked sufficiently. Pigs contract the disease by eating infected pork scraps in garbage and sometimes by eating infected rodent carcasses.

## Section II. RODENT CONTROL

### 224. General

Before selecting a method of control, surveys should be conducted to determine the species of the rodents present; to what extent they infest the building or area; where harborages and nests are located; what kind of food is being consumed; and the type of control best suited for the particular building and area.

### 225. Types of Control Measures

Control measures can be classified as suppressive and destructive. Permanent control is the only satisfactory method of suppressing rodents in long-range programs. Sporadic campaigns to des-

troy rats, although often effective in reducing their number for short periods, must always be repeated—with little likelihood of achieving long-lasting results. Any successful control program must be aimed at the destruction of rats and the elimination of their harborages and food supply. Once success has been attained the control program must be maintained continuously, otherwise conditions will soon revert to their former state.

a. *Suppressive Measures.* As long as food and shelter are plentiful, rats breed almost as fast as they can be destroyed. Their food and shelter, therefore, must be eliminated. Buildings should be rat-proofed by closing every opening one-quarter inch or more in diameter with hard materials like sheet metal, concrete, brick, or heavy screen. Small buildings may be elevated on concrete piers with metal flashings. New buildings should have rat-proof floors, foundations, and walls. All food must be kept in ratproof containers or buildings; mess halls must be kept clean; and garbage must be disposed of properly and promptly.

b. *Destructive Measures.* These measures—poisoning and trapping—should be carried on continuously. They are most effective at the start of the campaign before the older rats learn to avoid poison baits and traps; however, they will continue to be effective in the destruction of new arrivals.

## 226. Poisoning for Rat Control

The most economical means of effecting wholesale destruction of rodents is the use of poisons or, as they are called, rodenticides. Rodenticides are

used both as solid baits and as liquids. The preparation which best fits the conditions under which it is to be used should be chosen. Rodenticides should be used by trained personnel only.

## 227. Types of Poison

There are many rodenticides which may be used for rodent control. The two which are generally used in the Army are the anti-coagulants (Warfarin, etc.) and zinc phosphide.

*a. Anti-Coagulant Rodenticides.* These rodenticides contain either 0.5 percent or 4 percent warfarin, pival or other anti-coagulant. They are colorless, crystalline solids and have no odor or taste in the concentrations used for rat and mice control. They are the safest of the rodenticides presently used in the Army. Large quantities of the material, taken over a period of from 5 to 10 days, are required to effect a lethal dosage for man.

- (1) *Formula*: Mix the rodenticide with bait material as prescribed on the container label (cornmeal is readily accepted and is the most widely used carrier for this bait) ; use dry, in shallow containers. Percentage of rodenticide in finished baits is 2.5 percent.
- (2) *Toxicity*: Cumulative, average 2.87 mg/kg of body weight, taken over a period of from 5 to 10 days.
- (3) *Rat acceptance*: Very good ; no aversion.
- (4) *Hazards*: Relatively harmless to man and domestic animals, unless taken repeatedly.

(5) *Action*: Causes fatal internal hemorrhages.

(6) *Antidote*: Vitamin K, as prescribed by a medical officer.

b. *Zinc Phosphide*. This material contains 20 percent tartaric emetic and 80 percent zinc phosphide. Zinc phosphide is a dark gray powder which is insoluble in water and has a strong, pungent odor characteristic of phosphorous compounds. Since zinc phosphide deteriorates rather rapidly, baits containing it are relatively nontoxic after a few days' exposure to air.

(1) *Formula*: Mix with bait at a ratio of 1 part of zinc phosphide to 99 parts of bait. Baits containing oil are most satisfactory, as the oil increases the rate of absorption of phosphorous into the body.

(2) *Toxicity*: 35 mk/kg of body weight.

(3) *Rat acceptance*: Good; aversion to odor slight.

(4) *Hazards*: Highly toxic to all forms of animal life, including man.

(5) *Action*: Gastrointestinal irritation, brain and liver injury.

(6) *Antidote*: Emetics, potassium permanganate.

## 228. Baits

Baits are those solid foods which are used as carriers for rodenticides, and which are known to be attractive to rats. They may consist of any of the following materials: meat, fish, cereal or grain, fruits, and vegetables. There is no "best" bait for rats. Baits which are most effective in one locality

may be entirely unacceptable in another, and this may be true even for two adjacent establishments. Baits may be used in solid form, as cubes or slices coated with poison, or they may be ground and thoroughly mixed with the poison. Ground baits may be distributed in the form of unwrapped balls, or as torpedoes wrapped in 4-inch squares of kraft or confectionery waxed paper. Cubed slices approximately  $\frac{1}{2}$ -inch square, or a level teaspoonful, should be used for individual baits. It is important that baits be distributed in quantities no larger than necessary to control rats. Wrapped baits are probably more effective than bulk baits; but the latter should be used, when necessary, to keep rats from carrying baits where they might become dangerous to children and animals.

*a. Preparation.* Poisoned baits should be prepared with care and precision. When making small amounts of bait, metric scales, reading to 0.1 gm., are required. For larger batches, scales calibrated in pounds and ounces may be used. First, the poison should be mixed with the liquid or moist part of the bait formula; then this mixture should be blended with the dry ingredients. In a large poisoning program a machine grinder-mixer is economical. Ingredients should be mixed for from 5 to 10 minutes, depending on the consistency of the bait. For smaller quantities, hand-mixing with a large spoon in a dishpan will suffice, provided the ingredients are stirred and mixed thoroughly. Moist baits require more stirring than do dry baits to ensure uniform distribution of the poison. Baits containing hamburger, peanut butter, syrups, or similar foods need thorough mixing or kneading.



Poison should not be sprinkled over cubes or slices of bait from a shaker without additional stirring, as this will result in an uneven distribution of the poison. An even coating of poison over the bait can easily be secured by placing the poison and the cubes of fruit or vegetable bait into a bucket and shaking the bucket in a rotary motion for five minutes or more. It is essential that none of the poison be allowed to remain in the bucket after the mixing. Never put more than the recommended amount of poison in baits, as this will decrease acceptance by rats and increase the danger to man and domestic animals.

*b. Torpedoes.* Teaspoonful quantities of mixed bait for wrapping into torpedoes are placed in the center of 4-inch squares of paper. Paper waxed on one side is the most desirable. Squares should be no larger than 4 inches, otherwise the tendency will be to place too much material in each square. The paper with the mixture in the center is picked up by the four corners; then the corners are brought together and given a quick twist.

*c. Distribution.* Of greater importance than the kind of bait used is its proper distribution. Rats seek shelter and protection in their movements; therefore, baits placed in rat runways and harborage are far more likely to be accepted than are those exposed in the open. Proper placement is also necessary for the safety and protection of children and domestic animals. Whenever possible, baits should be placed under cover. A permanent bait box with two 2x3-inch holes cut in each end has the added attraction of providing harborage when trash piles or other rat shelters have been

eliminated. Baits should be distributed in groups of three to offer the rat a choice.

*d. Prebaiting.* Prebaiting will determine the most readily accepted bait or baits; where baits will best be taken; and how much material will be consumed at a feeding. Prebaiting consists of exposing fresh, *unpoisoned* bait materials, prepared exactly as the poisoned baits will be later. Food preferences of rats may also be observed by a careful examination of spilled, partly-eaten garbage and of the area and runways leading to the rat harborage. Test baiting is the only practical way to determine the best bait in any given case.

## 229. Trapping

The use of traps is recommended for measuring the density of the rat population and for trapping occasional migrants which have gained access to buildings. As a means of control, trapping is less economical than is the use of poisoned baits. Many traps must be used since, as a rule, less than 10 percent of the traps set are successful. Traps should be used when it is desired to determine the species of the population; when use of poisoned baits may be too dangerous to pets and humans or may cause contamination of food products; when it is especially desirable to avoid odors from poisoned rats that may die in inaccessible places; and when rats have become wise to the baits used.

*a. Types of Traps.* There are several types of traps used for rodents. The conventional type is the snap trap (rat trap, spring w/4-way release) which is used for the common domestic rats. A smaller size spring trap (mouse trap, spring, wood

base) is used for mice. When used properly, these traps are very efficient in catching rodents. But they are not suited for trapping rodents for ectoparasites, because the rodent usually dies and the ectoparasites may leave the body before they can be collected. A steel trap (trap, game, steel jaw, 16½ inch length chain, with auxilliary guard, delayed action type, 4-inch jaw opening) is effective in live trapping of rodents. Wire mesh traps, and a tin-can-mouse-trap combination (fig. 64) may also be used. The latter have been used with good results. Special types of traps are constructed for gophers and ground squirrels. See TM 5-632.

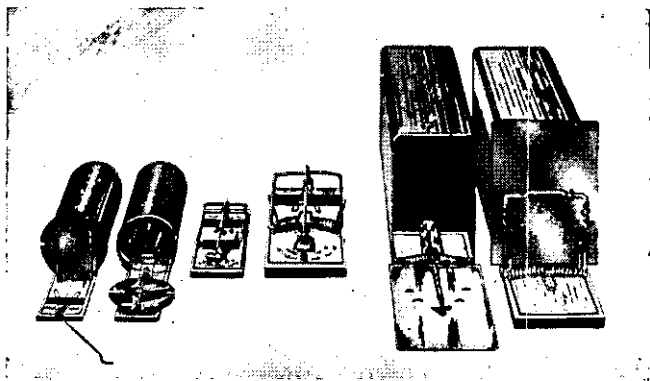

Figure 64. Four effective mouse and rat traps.

b. *Baits.* A variety of foods may be used for baiting traps. Despite its reputation, cheese is not an infallible bait. Bacon, walnuts, fresh coconut, fresh fish, or bread dipped in bacon grease have been particularly successful. The bait should be tied firmly to the trigger. Traps should be ex-

amined daily, and tainted bait should be removed and replaced with a fresh supply. It is not always necessary to use baited traps. To make an unbaited trap more effective, the trigger surface of an ordinary snap trap may be enlarged by using a square of cardboard or a piece of tin. The entire surface of the trigger-half of the trap then becomes a treadle to spring the trap. Human odors do not repel rodents from traps and may be accepted better than new, odorless traps.

*c. Trap Setting.* Considerable ingenuity is required in the selection of trap locations. Since rats move close to walls, traps should be placed near walls and in such a manner that they can be approached from either direction. It is well to protect traps by leaving boards or boxes over them. Whenever it has become evident that rats are avoiding the site selected, the traps should be moved to new locations.

### **230. Fumigation**

Fumigation for rodent control in buildings or ships is a hazardous process and should be carried out only with proper equipment and by properly trained personnel. At permanent installations in the zone of interior, rodents should never be allowed to become established in such numbers that fumigation would be necessary. Fumigation may be desirable for the control of wild or domestic rodents in burrows during an epidemic of plague.

### **231. Fumigation Agents**

The agents used in fumigation are calcium cyanide, carbon monoxide and carbon disulphide.

Calcium cyanide (cyanogas A) is the fumigant usually used in the Army and is issued for that purpose.

### 232. Fumigation Methods

a. *Calcium Cyanide.* Rodenticide, calcium cyanide, powder also called cyanogas A-dust, which gives off hydrocyanic acid gas (HCN) when acted on by the moisture in the air or soil. The fumigant dust is forced into burrows or other enclosed spaces by a special foot pump which is equipped with a flexible hose. When the hose is placed in the burrow, the open space around it should be sealed with earth. Cracks in the ground or other openings in the burrow system, through which dust may escape, must also be sealed to make the gassing effective. This operation should not be attempted at temperatures below 40° F. A moderate amount of moisture in the atmosphere or in the soil is necessary. In practice, the pump is first operated with the cut-off device in the "dust" position for about 5 full strokes; the lever is then switched to "air," and the plunger is operated for 10 full strokes, thus ensuring a thorough diffusion of the dust-air mixture throughout the entire system. Fumigation with hydrocyanic acid gas has the advantage of killing ectoparasites as well as rats.

b. *Carbon Monoxide.* Rats in dumps and burrows around the outside of buildings may be killed by carbon monoxide piped into the burrow by a hose attached to an automobile exhaust. The carburetor should be adjusted for a rich mixture and the engine allowed to run at a moderate speed for

10 minutes for the average burrow. Before treating burrows, all cracks and openings of connecting burrows should be sealed with earth to make them as gastight as possible.

c. *Carbon Disulphide*. Carbon disulphide on balls of cotton or waste may be placed in rat burrows which are then sealed. This method is most effective in damp weather and when the ground is wet. But it is also a fire hazard and should not be used near buildings.

### 233. Handling Dead Rats

Since the fleas, mites, and other insects which live on rats usually leave the body of the dead rat and remain nearby, dead rats should be collected as soon as possible and disposed of with care. They should be picked up with a tong, pitchfork, or similar instrument having a long handle. After they have been collected in insectproof containers, closely woven bags, or a metal container with a tight-fitting lid, they should be burned in the incinerator before any of the remaining insects can leave the bodies. In the presence of bubonic plague, personnel engaged in rat control duties should wear insectproof suits.

## CHAPTER 15

### MISCELLANEOUS DISEASES

---

#### 234. General

The foregoing chapters have covered four groups of communicable diseases, each made up of infections having similar means of spread. This chapter describes a number of preventable diseases which differ to such an extent in their means of spread from those already considered that they may be placed in a fifth group classified as "miscellaneous." Included in this group are tetanus, rabies, dermatophytosis, scabies, and plant dermatitis.

#### 235. Tetanus

*a. General.* Tetanus (lockjaw) is a rare but highly fatal disease which results from the introduction of tetanus germs into the body through a wound or burn. A deep puncture wound is usually the most dangerous, because the organisms are carried deep into the tissues; but tetanus may follow even the most trivial wound or burn. Normally, the tetanus germs live in the intestinal tracts of man and animals. These germs are very resistant. They will live for long periods of time after they have left the intestinal tract and are frequently found in soil which has been contaminated by feces. Because of the common occurrence of these germs in soil, any wound contaminated with dirt is dangerous.

*b. Control Measures.* The best method of control is active immunization. Upon entering the service, all military personnel are given a series of three tetanus toxoid injections. These immunizations make the individual resistant to tetanus for a period of time. Since this immunity is gradually lost, it is necessary that a "booster dose" of tetanus toxoid be given every 4 years. A "booster dose" must also be given promptly after the occurrence of a wound or severe burn. As a result of the Army's immunization program, cases of tetanus among military personnel are extremely rare.

### 236. Rabies

*a. General.* Rabies (hydrophobia) is a disease of animals which may be transmitted to man. It occurs in many wild and domestic animals but is most common in dogs. The organism causing the disease is present in the rabid animal's saliva and usually gains entrance into the body through a bite by the animal. The disease attacks the nervous system, and once it has developed it is always fatal. Every dog bite should be reported, because the dog may have rabies and the disease may develop in the individual bitten unless proper treatment is promptly received.

*b. Control Measures.* Control of rabies is based on prevention of the disease in dogs, treatment of bites, and vaccination of persons who have been bitten.

- (1) Dogs should be given rabies immunization periodically as recommended by the veterinarian, and the date of vaccination



should be marked on the dog's tag or collar. Dogs exposed or suspected of having been exposed to the infection should be held in quarantine for as long a period as the veterinary officer may recommend. Animals suspected of being rabid and dogs that have died of unknown causes should be turned over to the veterinary officer for disposition. Stray dogs should not be permitted on military posts but should be impounded and, if unclaimed, disposed of in a humane manner.

- (2) Any individual who has been bitten by an animal should report immediately to a medical officer for treatment of the wound and for determination as to whether a course of rabies vaccination is needed. If avoidable, the animal should not be killed. It should be captured and turned over to the veterinary officer for quarantine and observation. If the animal must be killed extreme care should be taken to see that the head and brain are not damaged. The undamaged head should be taken promptly to the nearest medical laboratory to be tested for rabies.

### 237. Dermatophytosis

*a. General.* The term "dermatophytosis" includes a group of skin diseases caused by fungi (microscopic molds) which attack the outer layer of the skin; they may also involve the hair and nails (example: ringworm, athlete's foot). The organisms grow best under conditions of warmth

and moisture; thus, dermatophytosis cases are more common in summer. They frequently occur in the moist, sweaty parts of the body; and they are more likely to be a serious problem in tropical or subtropical regions. These diseases are spread by direct skin-to-skin contact or by contact of the bare skin with contaminated articles of clothing, shoes, towels, floors, and the like.

- (1) *Ringworm*. Because of the tendency of many of these infections to form rings by circular spread of the infection at the edges while the center heals, the common name for fungus infections of the skin is "ringworm." The principal forms are ringworm of the scalp, beard, body, crotch, and feet. Often there is considerable itching. Ringworm of the crotch, commonly known as "jock-strap itch," is very troublesome in warm climates.
- (2) *Fungus infection of the feet*. Fungus infection of the feet is called epidermophytosis or "athlete's foot." It is the most common of all skin diseases and usually occurs as an inflammation of the skin between the toes and on the soles of the feet. It may appear as a thickening and scaling of the skin, as raw, inflamed areas, as cracked skin, or as blisters. Usually, there is considerable itching. Additional infection with other organisms may occur, adding to the inflammation and disability. Athlete's foot tends to flare up when the feet perspire. If neglected, complete cures are difficult to obtain.

b. *Control.* The preventive measures for all forms of dermatophytosis are directed toward preventing contact with infected individuals or with articles contaminated by an infected individual and building up resistance through personal hygiene.

- (1) *Care of feet.* Proper care of the feet, especially keeping them clean and dry, is particularly important in the prevention and control of athlete's foot. Feet should be protected against infection and contamination by the use of sandals in showers, dressing rooms, and other areas where people may go barefooted. Shoes should be properly fitted and ventilated. Feet should be washed daily and dried thoroughly, especially between the toes. Persons whose feet perspire freely should apply foot powder lightly and evenly twice a day.
- (2) *Treatment of cases.* Active cases of dermatophytosis should receive prompt and thorough treatment under the supervision of a medical officer. If the disease is prevalent, the feet of all personnel should be inspected at certain intervals and cases detected should be brought to treatment.
- (3) *Disinfection of floors and equipment.* Bathhouse floors and equipment such as mats, benches, and chairs should be scrubbed daily with soap and water, then flushed with water and dried out. In warm weather, screened windows should

be kept open to permit the direct rays of the sun to shine on the floor. Duckboards, if used in shower baths, should be removable so that they can be scrubbed thoroughly and exposed to sunlight for several hours each day; and two sets should be provided, each to be used on alternate days. Unless they have been thoroughly disinfected, towels, gym suits, and similar articles should not be exchanged or used in common. Articles which do not become damaged by boiling may be sterilized in that way.

### 238. Scabies

*a. General.* Scabies (the itch) is a contagious skin infestation caused by a tiny itch mite. The mite burrows into the skin causing a rash which occurs in patches and is accompanied by severe itching. The itching becomes more severe at night. Parts of the body which are most frequently involved are the front of the wrists, webs of the fingers, lower abdomen, genitals, and buttocks. The itch mite usually is transmitted by direct contact, although occasionally it may be transmitted indirectly by underclothing, bedding, and towels which have been used by infected persons.

*b. Control Measures.* Cleanliness of the body, of underclothing, and of bedding is the most important preventive measure. Individuals who suspect that they have scabies should report to a medical officer for immediate treatment, and all men who have been in daily contact with a case

should be examined carefully. See paragraph 200b (2).

### 239. Plant Dermatitis

a. *General.* In some persons the sap or juice of certain plants will cause skin eruptions. The most common of these plants are poison ivy, poison oak, and poison sumac. While most cases result from direct contact with the plant, it is possible to get the eruption without actually touching the plant, because the sap may be carried on tools and clothing. Cases have even resulted from the smoke of fires while burning these plants. The skin eruption, accompanied by severe burning and itching, appears from within a few hours to several days after exposure, usually on the hands, forearms, and face. At first there are redness and swelling, followed later by blisters. The blisters break in from two to four days, leaving a raw surface. This surface then becomes crusted and usually heals within two weeks.



Figure 65. Poison ivy

*b. Identification of Plants.* Individuals should learn to identify these plants. Poison ivy (fig. 65) is a creeping vine with leaves growing in clusters of three instead of five. Sometimes, but not always, the leaves are toothed on the sides. Poison oak, which is especially plentiful in the Western United States, is a shrub or small tree with leaves also growing in clusters of three, but the sides of its leaves are usually more distinctly toothed. Poison sumac is a shrub or small tree which grows in swampy places. It has smooth-edged leaflets on red stems and small round, white fruits.

*c. Control Measures.* When selecting camp sites, areas where these plants grow should, if possible, be avoided. Persons working in areas where these plants are found should wear gloves. Outer clothing and gloves should be changed upon leaving the area, and contaminated tools should be kept apart from others. Vegetation should be burned at a distance and on the leeward side of the camp site so that the wind will carry the smoke away from camp. If exposure has occurred, all parts of the body which have been exposed must be washed immediately, several times in succession, with a strong soap solution or with alcohol, a fresh solution being used each time. Contaminated clothing and tools should be washed with soap and hot water. If the eruption appears, a medical officer should be consulted.

# CHAPTER 16

## ADAPTATION AND THE PROBLEMS OF EXTREME CLIMATE

---

### Section I. GENERAL

#### 240. General

The average American soldier is prepared and trained to do his best work in climates that are similar to those to which he has been accustomed in the United States. Sometimes, however, it is necessary that he be prepared and trained for duty in areas where extremes of temperature are encountered, as in the tropics or in the arctic. The processes of preparing and training the soldier to function effectively in all kinds of climate are known as "adaptation" and "conditioning."

*a. Adaptation.* Adaptation is the process whereby one adjusts to the climatic environment thereby minimizing the effects of extreme moisture, heat, or cold. Included in this process is the adjustment to living in situations that are different from those to which one is accustomed.

*b. Conditioning.* When moved into a locality where the temperature is either extremely high or extremely low, the body must become accustomed to these extremes of climate for effective performance of duty. The body will make a gradual adjustment naturally. But this adjustment can be hastened and facilitated by training. The amount

and duration of these special training activities are increased daily until the conditioning has been completed.

#### **241. Responsibility**

During the period of adaptation and conditioning, troops are carefully supervised by commissioned and noncommissioned officers. Included should be a planned program of instruction covering both mental and physical training problems and hazards. Proper arrangements should also provide for recreational opportunities, properly adjusted to the conditions and demands of the climate.

### **Section II. LIFE IN THE TROPICS**

#### **242. General**

a. Even though he be in good physical condition, before a man can do heavy work safely in hot desert or tropical climate he must go through a period of physical adaptation (sometimes called acclimatization). This adaptation is nature's way of adjusting the cooling equipment of the human body to meet the strain imposed on it by a hot environment. The major portion of a normal man's adaptation to heat takes place automatically in from five to seven days, but this requires that he observe a few common-sense rules of exercise and rest. Stated in simplest terms, these rules are:

- (1) Increase the work load gradually.
- (2) Increase the exposure to heat gradually.
- (3) Get plenty of rest between exercise periods and at night.



b. Full acclimatization to the heat (the ability to perform a maximum amount of strenuous work) will be reached most quickly if moderate work is begun at the time of first exposure to the heat and then is increased progressively within the limits of the individual's tolerance. A schedule of alternating work and rest periods should be established. During the first two or three days the work periods should be set mainly for the cooler hours of the morning and the afternoon. Then gradually increasing amounts of work during the hot part of the day should be added. The scheme outlined below is suggested as a guide; it should not be followed slavishly, as local conditions may require modification. After once being acclimatized, a person can retain his adaptation to heat for from one to two weeks after he leaves the hot environment. Then, if not re-exposed to high temperature, the acclimatization will gradually be lost. Most men lose the major portion of their acclimatization within a period of one month after having left the tropics or the desert.

*Moderate Conditions*

Desert: (air temperature *below* 105° F.)

Tropical: (air temperature *below* 85° F.)

|                 | <i>Hours of Work</i> |                  |
|-----------------|----------------------|------------------|
|                 | <i>Morning</i>       | <i>Afternoon</i> |
| First day.....  | 1                    | 1                |
| Second day..... | 1½                   | 1½               |
| Third day.....  | 2                    | 2                |
| Fourth day..... | 3                    | 3                |
| Fifth day.....  | Regular Duty         |                  |

### Severe Conditions

Desert: (air temperature above 105° F.)

Tropical: (air temperature above 85° F.)

|                 | Hours of Work |           |
|-----------------|---------------|-----------|
|                 | Morning       | Afternoon |
| First day.....  | 1             | 1         |
| Second day..... | 1½            | 1½        |
| Third day.....  | 2             | 2         |
| Fourth day..... | 2½            | 2½        |
| Fifth day.....  | 3             | 3         |
| Sixth day.....  | Regular Duty  |           |

c. Commissioned and noncommissioned officers who know the work capacities of their men can determine the degree of their acclimatization and whether or not it is safe for them to continue on a given activity. The acclimatized man is alert, performs his work energetically, and is without abnormal symptoms. In contrast, the unacclimatized man who is working too hard in the heat becomes dull and apathetic, performs his work poorly, and, to varying degrees, may show symptoms of heat exhaustion.

### 243. Water Requirements

a. Water requirements of the human body vary with the temperature and the amount of exercise. At air temperatures above 95° F., the only means by which the body is cooled and heat exhaustion is prevented is through the evaporation of sweat. In the jungle where the humidity is high, sweat does not completely evaporate but runs off the skin; therefore, cooling is less efficient and water losses may be greater.

b. At high temperatures, during the day, a man who is resting may lose as much as a pint of

water per hour by sweating; if he is working, his water loss (and requirement) will increase in proportion to the amount of work done. Since the water requirement varies with the amount of work being done, the supply of water must be sufficient to provide for the maximum amount of work that troops may be doing. Hard-working units, such as engineers, marching men, and labor battalions, may require as much as three gallons of drinking water per man per day. A table of water requirements is shown below.

**WATER REQUIREMENTS**  
 Quarts per Man per Day for Drinking Purposes  
 (A guide for planning purposes only)

| <i>Activity</i> | <i>Illustrative Duties</i>                | Quarts per Man per Day for Drinking Purposes Only |                                    |
|-----------------|---|---|------------------------------------|
|                 |   | <i>Moderate Desert or tropical*</i>               | <i>Severe Desert or tropical**</i> |
| Light           | Desk work; guard and KP duty.             | 6   | 10                                 |
| Moderate        | Route march on level; tank operation.     | 7   | 11                                 |
| Heavy           | Forced marches; stevedoring; entrenching. | 9   | 13                                 |

\*Desert: Air temperature below 105° F.  
 Tropical: Air temperature below 85° F.

\*\*Desert: Air temperature above 105° F.  
 Tropical: Air temperature above 85° F.

During excessive labor in extremely high temperatures (110° F. or greater) with low humidity, or in high temperatures (90° to 100° F. or greater) with high humidity, water requirements may increase above these levels. Any restriction

of water below the amount needed for efficient cooling will result in rapid loss of efficiency, reduction in the ability to work, and deterioration of morale. If water restriction is continued for hours, body temperatures will rise and heat exhaustion will occur. There is no advantage in the use of thirst quenchers such as chewing gum or fruit drops. For a given amount of work under high temperature conditions, water consumption is substantially the same whether water is taken only at mealtimes or whenever one is thirsty. Those who delay drinking until mealtime may experience considerable discomfort without any apparent advantage in water economy but with a loss of physical well-being. The greatest benefit will be obtained and maximum efficiency will result if water is taken at short rather than at long intervals. Drinking in small amounts, when thirsty, is the best practice. This will avoid the danger of cramps resulting from drinking large quantities of water at one time. When the water supply is limited, unit commanders should economize in its use by having their organizations do the required heavy work and strenuous marching during the early morning, early evening, or night hours, if possible. Up to 40 percent of the daily fluid requirement may be saved by this method.

#### **244. Salt Requirements**

*a.* When water is lost through perspiration, vital body salt is also lost. An ordinary diet contains enough salt to make up for this loss when a person's water intake is less than 1 gallon a day. If the daily water intake is increased to 1½ gallons

it is still possible to take in an adequate amount of salt, through the diet by adding extra salt to prepared food. The amount of salt that can be spread over the food in three meals is approximately one-half teaspoonful, which amount, well-distributed, will not spoil the taste of ordinary food for most people. In hot climates, if a full diet is not eaten while troops are performing strenuous duty there will be a salt shortage in the body. It then is important that the salt requirements of the body be replenished by adding salt to the drinking water or by taking salt tablets. Coated salt tablets which are made to dissolve slowly in the intestines are available. These tablets will prevent the nausea and sick feeling sometimes felt after taking the plain salt tablets. The tablets should be swallowed whole and should be taken while drinking water or at mealtime. When there is much sweating, two tablets should be taken for every quart of water consumed. Some people prefer to take their extra salt in the form of lightly salted water. This is an excellent method.

b. The amount of table salt used for different water containers is as follows:

- (1) One pound table salt to 100 gallons of water.
- (2) 0.3 of a pound table salt to the lyster bag (36 gallons).
- (3) One-fourth teaspoonful table salt to each canteen of water.
- (4) Two 10-grain salt tablets dissolved in each canteen (quart of water).

c. If there is a shortage of water, extra salt should not be taken.

## 245. Special Conditions Caused by Extreme Heat

*a. Heat Exhaustion.* This condition is caused by excessive loss of water and salt from the body. The symptoms of heat exhaustion are headache, excessive sweating, pallor of skin, weakness, dizziness, and muscle cramps. The skin is cold, moist, and clammy. Heat exhaustion may come on gradually or it may happen suddenly. Few deaths occur from heat exhaustion; but, if untreated, severe cases may prove fatal. The victim should be placed in a cool, shady spot and given large quantities of salted water by mouth (par. 244b). Following such emergency first aid, the patient should be taken to the nearest medical facility.

*b. Heatstroke.* Prolonged exposure to high temperature may cause heatstroke (occasionally referred to as "sunstroke"). This is serious and calls for prompt treatment. Heatstroke is most apt to strike persons who are not acclimatized to heat. The first sign of heatstroke may be stoppage of sweating which will cause the skin to feel hot and dry. Collapse and unconsciousness may come suddenly, or they may be preceded by headache, dizziness, fast pulse, nausea, vomiting, and delirium (raving). It is necessary to work fast to save life, as the heat regulators of the body have been damaged and the temperature may rise to 107° F. or 108° F. Place the patient in the shade and remove his clothing. Sprinkle the body repeatedly from head to foot with cool water to reduce the temperature. While continuing the wetting-down procedure, give cold water by mouth if the patient is able to drink. Skin circulation should

be increased by rubbing the arms, legs, and trunk. Fanning the body will increase water evaporation which speeds up the cooling effect. As soon as possible the patient should be taken to the hospital, treatment being continued on the way. The individual who has once had either heatstroke or sunstroke is likely to suffer other attacks with lessening degrees of response to treatment.

*c. Heat Cramps.* Heat cramps are painful spasms of the muscles, usually those of the legs, arms, and belly wall. They may be either mild or severe. Cramps are due directly to lack of salt in the body and are relieved when this loss is replaced. Treatment consists of drinking large amounts of salt water. Severe cases may have to be sent to the hospital for injections of salt solution into the veins.

*d. Sunburn.* Severe skin burns may result from relatively short periods of outdoor exposure on cloudy as well as on clear days in tropical and in desert areas. Suntan should be acquired gradually, preferably in the early morning or late afternoon, and without exposing too much of the body at one time. A good method is to start with a 5-minute exposure and to increase the exposure gradually at the rate of 5 minutes each day. Even after a good tan has been acquired, excessive sun bathing in tropical or desert areas is never wise. Persons with freckles or auburn hair should be particularly careful as they are especially susceptible. Considerable protection from sunburn is given by the "issue" sunburn ointment.

*e. Prickly Heat.* Prickly heat is an irritating inflammation of the skin associated with excessive

sweating. It usually starts around the waist and the armpits as in intense itching from numerous tiny blisters. As a result of prickly heat, the skin may become infected causing troublesome sores. Clean, loose, dry clothing will help to prevent prickly heat. After bathing, the skin should be thoroughly dried. Too frequent bathing and use of soap seem to make prickly heat worse as the natural protective oils of the skin are removed by the soap. Severe cases of prickly heat should be referred to the medical officer for treatment. Gradual suntanning seems to help increase resistance to prickly heat.

#### **246. Fungus Infections**

Chronic, disabling fungus infections of the skin are more common in hot countries than in cooler climates. Excessive sweating causes softening of the skin and makes moist areas such as the groin, crotch, armpits, and feet ideally suited for the growth of the tiny plant-like germs which cause these conditions. The prevention of fungus infections is much easier than is their cure. The practice of preventive measures will do much to maintain comfort and health in the jungle (par. 237).

#### **247. Summary**

Tropical diseases are not mysterious maladies; in general, they are well understood; they are preventable; and in most cases they are curable. To get along well in the tropics, it is necessary to follow the simple rules of hygiene; to cultivate certain health habits; and to take a few extra sanitary precautions.



### Section III. LIFE IN THE ARCTIC

#### 248. General

a. The popular belief that a cold, lonely, miserable life is all that exists in the arctic is not true. People have lived in and made the arctic their home for centuries, and many actually prefer life in the arctic to life elsewhere. While a large part of the arctic is barren, there are areas where vegetation and animal, fish, bird, and insect life abound. It does get cold, but one can learn to keep warm. Nature imposes her own stringent laws upon the inhabitants of the north, but the soldier can get to know and understand the arctic so that, while learning to respect it, he will not fear it.

b. In the summer, mosquitoes and "flies" are extremely numerous and the use of nets, gloves, insect repellents, and smudges on bivouac are needed to prevent annoyance and suffering. The arctic mosquito, while a particularly vicious biter, does not transmit malaria or yellow fever. The word "flies" as used here does not refer to the common type, such as the housefly or the blue-bottle fly, but rather to biting and blood-sucking varieties, such as midges, black flies, deer flies, horseflies, and moose flies. These types are very numerous and will attack the unprotected in hordes, several species attacking at one time.

c. In the winter the body must supply an increased amount of heat. The proper kind and amount of food must be consumed to generate this heat. The diet prepared for the troops in the arctic, therefore, contains more calories than are needed for heavy work in temperate climates.

This extra food is in the form of sugars and fats. In the arctic the digestive system becomes adjusted to assimilating this extra amount of food without discomfort. Should a person eat game, either for the sake of survival or for pleasure, several things must be kept in mind. First, all game must be thoroughly cooked, since in certain areas of the north some game species, especially bear, are infected with small parasitic worms called trichinae. If the meat is undercooked these worms can cause a serious infection known as trichinosis. Second, the liver of a polar bear or of a bearded seal should never be eaten since it contains such a high concentration of vitamin A as to make it very poisonous to man.

*d.* Even though a large portion of the arctic is uninhabited, living conditions in the inhabited areas are crowded, and special precautions must be taken to prevent the spread of respiratory, intestinal, and skin diseases. This calls for particular care in personal hygiene, ventilation of quarters, and waste disposal.

#### **249. Responsibility**

In the arctic regions commissioned and non-commissioned officers assume a special burden of responsibility for the health and safety of their troops. Frequently, the climatic and environmental conditions are so hazardous that the lives of the men may be endangered unless all eventualities are prepared for and all necessary precautions are taken. Training and indoctrination to prepare troops for safe and comfortable living in the arctic must be serious and thorough. Each man must

adjust himself to his new life so carefully and so skillfully that he will be able to outwit the elements and cope with any emergency.

## 250. Keys to Survival in the Arctic

The keys to survival in the arctic are:

- a. Proper use of arctic clothing.
- b. Conservation of fuel, energy, and body heat.
- c. Proper use of "issue" rations.
- d. Taking proper precautions against carbon monoxide poisoning.

## 251. Clothing

a. Arctic clothing is designed to afford protection, insulation, and ventilation: protection, by covering as large an area of the body as possible; insulation, by trapping air which has been warmed by the body and holding it to the skin, thus preventing loss of heat by its escape from the body; ventilation, by allowing a two-way exchange of air through the various layers of clothing. This prevents overheating, while at the same time it protects against chilling of the body surface. Perspiration, grease, and dirt, if allowed to remain on the clothing, will cut down its insulating qualities so that it will not retain heat as it should. To preserve its warming ability, there must be some movement of air through the clothing. The amount of arctic clothing that should be worn and the manner in which it is worn should leave the body slightly cool rather than hot. Also, clothing must be loose enough to allow movement and exercise of the hands, feet and the rest of the body so as to improve circulation. Essentially, the purpose

of arctic clothing is to prevent the escape of body heat, to prevent wind-chill, and to allow the air to circulate within the clothing so that there will be no excessive sweating due to overheating.

*b.* To keep warm:

- (1) Keep clothing clean.
- (2) Avoid overheating.
- (3) Wear clothing in loose layers.
- (4) Keep clothing dry.

These four rules are the key to comfort.

## **252. Special Conditions of the Arctic**

It is advisable that troops in the arctic be paired as "buddies," each having the responsibility of watching the other for signs of frostbite and of reminding him to take warming exercises at frequent intervals. Conditions especially to be guarded against are frostbite, trenchfoot, freezing, snow blindness, and carbon monoxide poisoning.

## **253. Frostbite and Freezing**

*a.* These conditions are noticed first on the exposed areas of the face and on the toes and fingers. They are aggravated by fatigue, starvation, and poor circulation. Poor circulation can be caused by tight clothing or by becoming chilled when insufficient clothing is worn.

*b.* The body parts most easily affected by frostbite are the checks, nose, ears, chin, forehead, wrists, hands, and feet (fig. 66). Frostbitten skin is whitish, stiff, and feels numb rather than painful. Treatment for frostbite is to warm the affected part gradually at room temperature or, if



*Figure 66. Frostbitten hand.*

the part is still frozen, by immersion in warm water (90° to 104° F.). An emergency treatment for a frostbitten hand is to withdraw the affected hand from the loose sleeve of the parka and warm it in the armpit under the clothing. Small frostbitten areas on the face are best thawed by putting the hand inside the parka, as before, and bringing it out at the side of the hood to warm the face. Frozen feet may be thawed under a buddy's cloth-

ing. Never rub frostbitten parts, as friction may damage the tissue. Never apply snow to a frostbitten part, because snow is of the same temperature as the weather which caused the freezing and will therefore aggravate the condition. Be continuously alert to whitening, stiffness, or numbness of the skin.

c. The condition sometimes referred to as frozen or frosted lungs does not exist. Even while exercising hard at 50° F. below zero, despite the discomfort which a man may feel, no damage is done to the lungs. Mild inflammation of the upper airway may result—sore throat and/or hoarseness—but even this is rare.

d. Trench foot or immersion foot is an injury which results from fairly long exposures of the feet to continued wet conditions, generally at temperatures a little above freezing. These conditions prevail in the Arctic during certain seasons but are found even more often in temperate climates during the spring, winter or fall. Rain, sleet, or the thawing of snow or frozen soil may make the ground so wet that the boots and socks of soldiers in the field become soaked or damp. If men are inactive, as in fox holes, this combination of wet feet, cold weather and little movement causes changes in the circulation of the blood to the feet. The injury done to the feet by these changes may be very serious and lead to the loss of toes or parts of the feet. Fortunately this condition is preventable. Every man must take care of his feet. When socks get wet, they should be changed for a dry pair. While the feet are bare, they should be massaged and rubbed until warm and the flow

of blood is increased. Feet can be kept dry while standing in wet fox holes by putting stones, pieces of log, branches or brush on the bottom so that the feet stand above the water or mud. Deeper drainage sumps can be dug to one side of the hole or standing steps can be provided. Socks may be dried under field conditions by putting the wet socks under the shirt where the body heat will help to evaporate the moisture. Alternating two pairs of socks in this fashion will aid greatly in keeping the feet dry.

#### **254. Snow Blindness**

The effects of glare from ice and snowfields may cause snow blindness. This can occur even though the sun is not shining. In fact, snow blindness occurs more often in hazy, cloudy weather. The early stages of snow blindness can be recognized by a scratchy feeling when the eyes are closed. In severe cases, the eyes should be bandaged with a dark cloth, shutting out all light; and medical attention should be sought at once. Sunglasses should be carried and used at all times in areas of unbroken ice or snow. Should the sunglasses be lost, an emergency pair may be made of a thin piece of wood or cardboard, the width of the face, by cutting slits into the board and holding it in place with a string (fig. 67). Sometimes blackening the eyelids and face around the eyes will absorb some of the harmful rays. The same condition that causes snow blindness can cause snowburn of skin, face, wrist, lips, and eyelids. If neglected, the disabling results of snowburn are similar to those of sunburn.



*Figure 67. Improvised sunglasses.*

## 255. Alcohol

Alcohol is ineffective in combatting the cold. In cold weather the human body shrinks up the small blood vessels which lie just beneath the skin over the whole body surface, thereby reducing the flow of warm blood to the surface from which heat may be lost by radiation to the surrounding air. When alcohol is taken, one of its affects is to cause expansion of these small vessels. While this gives a temporary feeling of warmth, body heat will rapidly be lost from the large radiating area of the flushed skin. The loss of heat from the core of the body causes a great deal of extra work for the heat-producing mechanism of the body, and this machinery may be unable to keep up the extra demand. When the body heat has been lowered the person not only is truly cold, but his exposed parts and his hands and feet will more easily be-



come frostbitten. Another harmful result of alcoholic drinking is the false sense of security it gives. The drinker may have such a sense of well-being that he will neglect to take sensible precautions and fail to recognize the early warning signs of trouble. Furthermore, when the body heat has been lowered and an injury occurs, shock may develop more rapidly.

## 256. Carbon Monoxide Poisoning

*a.* Carbon monoxide (CO) is a gas produced by the incomplete combustion of coal, oil, and other fuels. When sufficient amounts of the gas are inhaled there can be severe, prolonged, and sometimes fatal results. Faulty ventilation and leaky hot air heaters, motor vehicles, exhaust fumes from field ranges, and lighting and heating devices with poor combustion of fuel or careless arrangement of ventilation in cramped, sealed-in quarters can cause carbon monoxide poisoning unless appropriate preventive measures are strictly carried out.

*b.* Carbon monoxide is colorless, tasteless, and practically odorless. It destroys the ability of the red blood cells to carry the needed oxygen to the body tissues. The symptoms of carbon monoxide poisoning come on rapidly and in quick succession. Dizziness, headache, noises in the ears, and throbbing in the temples are quickly followed by a feeling of sleepiness and weakness. Vomiting and convulsions may occur, followed by unconsciousness and death. The individual who is becoming poisoned may realize what is taking place, but he may not have enough strength left to get out into

the fresh air. Under circumstances in which there is muscular exertion or where there are extremes of temperature or humidity, the effects of the poisoning act more rapidly. If anything even remotely suggests this condition, immediately but with the least possible exertion, shut off all lighting and/or heating mechanisms that could be a possible cause, and seek open air and help. Hysteria or rushing about may cause the expenditure of just enough extra energy to block the successful performance of these measures. Therefore, they should be performed calmly and deliberately. Seek medical care at once. In cold climates, always make sure that there is adequate ventilation before going to sleep, no matter how severe or bad the weather conditions may be.

# CHAPTER 17

## MARCH HYGIENE AND CAMP SITES

---

### Section I. MARCH HYGIENE

#### 257. General

Notwithstanding the increasing use of motor transport in modern warfare, soldiers still must make foot marches. A march is successful when the troops get to their destination on time and in condition to carry out their mission. Unless proper march hygiene is practiced, some of the troops may not arrive at the destination; some may arrive late; and some may arrive in such poor physical condition that they are unable to work or fight. If proper march hygiene is practiced before, during, and after the march, troops can be counted on to arrive at their destination on time and in condition to execute their mission.

#### 258. Inspections Before Marches

Before starting on a march, each unit commander should make certain that every man in his command has had a thorough inspection. This should include a detailed inspection of the feet, footgear, clothing, and equipment, and a determination of the man's physical fitness for making the march. Steps must be taken immediately to correct any defects that may impair the activity and stamina of the men. Improperly fitted footgear and/or clothing may restrict circulation and

in other ways produce march casualties. Cold and wet weather conditions, combined with tight footgear, may result in trenchfoot. Men who appear to be ill or otherwise physically unfit should be sent to the unit medical officer for an evaluation as to whether they are able to make the march.

### **259. Conduct of March**

Except in emergencies, marches should seldom exceed eight hours' duration. Whenever possible a hot meal including energy-producing foods such as sugars (carbohydrates) and fats should be served before a march is begun. Normally, well-trained and well-conditioned troops in a regiment or smaller unit will march from 15 to 20 miles in an eight-hour period. In extremely hot temperatures marches should be conducted in the early morning, late afternoon, or at night. This schedule, of course, may be adapted to the physical condition of the troops.

### **260. Halts**

Halts are made at regular intervals so that the men may rest, adjust their equipment, and relieve themselves. At the end of the first 45 minutes of marching it is customary to call a 15-minute halt so that all personnel can thoroughly check their clothing and adjust their equipment. During this shakedown period all clothing and equipment should be properly arranged so as to prevent rubbing, bouncing, unequal strain, or other conditions that would increase fatigue during the march. After the initial rest period the usual halt is 10 minutes out of each hour.

a. All units of a march column stop and start at the same time. This system is regulated by watches which are synchronized before the march begins. At the "halt" signal all units move to the side of the road and fall out to rest. Whenever possible, halts should be made in areas where the men can get the maximum of comfort and rest. During these rest periods the men should be encouraged to remove or loosen their packs and to relax. To improve blood circulation and to keep the feet from swelling, feet and legs should be elevated by placing them on rocks, banks, or logs. Often it is necessary to loosen the shoes after a few hours of marching in order to allow for the slight swelling of the feet which usually occurs on long marches. At rest periods, human waste should be disposed of in small individual pits (cat holes) which are dug with an entrenching shovel and covered immediately after use. Saddle trenches should be dug at the noon halt and at temporary bivouacs of less than a week's duration.

b. It is desirable to finish the day's march as early as possible; long halts, therefore, should not be made unless special conditions require that this be done. The starting time of the march, the length of the march, or the desire to avoid excessive heat may make it advisable to call a long halt at midday. This will depend largely on existing circumstances as well as on the degree of training and the physical condition of the troops involved.

c. Units execute long halts by moving into temporary bivouacs near the march route which, if possible, has previously been reconnoitered. In selecting the location for a halt, the comfort as

well as the security of the troops must be considered. Preferably, the location should be near a water supply, shady, and have the type of soil which will make waste disposal easy.

## 261. Health on the March

Many of the discomforts of marching can be reduced by good judgment and foresight.

*a.* Whenever feasible, the route of the march should be reconnoitered and marked before the march is begun. Adequate preparation for stream crossings and the removal of obstacles will reduce unnecessary delay. Fords, bridges, and ice-covered ponds should be examined carefully before crossings are attempted. All natural water sources along the route of march must be considered unsafe for drinking, and all drinking water must be properly treated before use. Water must be obtained from approved sources only (usually from an engineer water point). If this is not possible, unit or personal water purification methods must be used (ch. 3).

*b.* As a rule, ambulances follow in the rear of the column of march to take care of men who may become disabled and cannot continue the march on foot. Unit commanders should watch their men closely for signs of fatigue, illness, and other disability. To prevent march casualties, blisters and minor foot illnesses should be treated promptly. Men who are unduly fatigued should be relieved of their packs, and those who become sick should receive immediate medical attention. The medical officer attached to a troop unit marches at its rear; his duty is to examine all men who have been per-

mitted to lag behind (stragglers). If their condition warrants, the medical officer will give them a permit admitting them to the ambulance, or he may authorize them to place their equipment in one of the convoy vehicles. After the necessary treatment, the medical officer may direct the men to rejoin the foot column.

c. Cold weather hardships on marches are lessened when the men are dressed in suitable, warm clothing. Ears, face, hands, and feet must have special protection. All unit commanders should be equipment conscious and insure that their men are well fitted out and properly equipped. They should make every effort to obtain the best possible clothing and equipment issued by the quartermaster for the type of weather expected. Whenever the chance presents itself, troops occupying cramped positions in vehicles should be permitted to run along the road "to remove the kinks." Foot troops can sling their weapons over their shoulders to permit free arm movement.

d. Since snow and ice make marching more difficult, the trail-breaking job should be equalized by having the leading elements change frequently. In deep snow it may be necessary to have the trail broken for foot troops by either a bulldozer or a snowplow. If such conditions are prevalent, troops may be equipped and trained in the use of snowshoes and skis. Tinted glasses may have to be used to prevent snow blindness.

e. More detailed information regarding the proper handling of the foot march is contained in FM 21-18.

## Section II. SELECTION OF CAMP SITES

### 262. Advance Quartering Party

*a.* Quartering parties are set up to simplify the occupation of a bivouac or shelter area by the completion of proper arrangements, before the troops arrive, to insure that all command, administration, and supply functions will go on without interruption. Normally, these parties consist of a chief quartering officer, a medical officer, a mess assistant, and representatives of subordinate units. Quartering parties proceed separately to their assigned areas before the march begins. However, if the areas are assigned during the course of the march, the members of the parties will leave their positions in the column sufficiently in advance to allow time for staking out and surveying the area.

*b.* Subject to the approval of the area commander, quartering parties select the bivouac area; make detailed arrangements for its occupation; allot areas and facilities to subordinate units; and reserve locations for special administration and supply facilities, such as headquarters, dispensary, and message center. Sanitary plans, too, are completed before the main body of troops arrives.

### 263. Procedure on Arrival at Camp Site

When foot troops arrive at a new camp site they should proceed immediately to their bivouac areas, unslung their packs, and pitch tents. As soon as possible after arrival at the camp site the unit commander should:



- a. Serve a hot meal, if possible.
- b. Verify the location of the engineer water point, or check the purification treatment of the water supply if unit or individual methods are to be used.
- c. Issue orders regarding sanitation and the protection and purification of water.
- d. Check on the condition of the men's feet and footgear.
- e. Inspect all organizations: arrange to have injuries treated and other defects corrected.
- f. Announce sick call.
- g. Consult the medical officer about men who seem to be physically unable to continue on full duty status.

#### 264. Selection

Camp sites are selected according to well-defined military and sanitary rules. As far as the tactical situation permits, the factors of security, availability of supplies, sanitation, ease of administration, and comfort of the troops determine the selection of bivouac areas. Even though the military situation may make it necessary to select a site which does not fully meet all sanitary requirements, great emphasis should be placed on all comfort and health considerations so far as this will not interfere with the military mission. While the selection of a camp site is the responsibility of the area commander, medical officers are responsible for making sanitary surveys and submitting recommendations concerning the suitability of proposed sites from the standpoint of health. In large units, usually, the recommenda-

tions of the engineer and quartermaster officers are also required.

## 265. Sanitation

*a.* Since careless disposal of human waste can cause serious epidemics, some type of latrine must be built immediately upon going into bivouac. Latrines should be located at the opposite side of the camp from the kitchens and be so placed that their drainage cannot pollute the water supply. Straddle trench latrines and garbage pits should be dug immediately. If the stay is to be longer than one week, deep pit latrines can be set up later. Bivouac areas must be kept policed at all times and all refuse and garbage promptly burned or buried.

*b.* Under combat situations in the field, water normally is obtained from engineer water points where it is treated and made potable. This water should be so handled that it will not be exposed to contamination after it has been taken from the water point. A minimum chlorine residual of one part per million should be maintained at all times, even though this may require rechlorination with the use of chlorine powder (calcium hypochlorite ampuls). When water is taken from a city water supply system it should also be rechlorinated to produce a chlorine residual of one part per million. Although the water may be potable when taken from the water system, there are many chances of contamination during handling and transportation. For this reason a constant high chlorine residual is required when troops are in the field.

*c.* When the camp has been established, the

medical officer has technical supervision over matters pertaining to health and sanitation. He will see to it that sources of drinking water are approved and tested; that latrines are set up as needed; that measures are taken to dispose of refuse and garbage; that field messes are inspected regularly; that good general sanitation exists; and that dispensaries are established. In general, he acts as the health officer of the area as well as the physician for the command.

## **266. Desirable Features for Camp Sites**

Features most desirable for camp sites are—

- a.* Sandy loam or gravel soil, favorable for proper waste disposal.
- b.* Firm, grass-covered surface.
- c.* Elevated, well-drained site.
- d.* Sufficient space to avoid crowding of troops and to permit adequate distances between kitchens and latrines.
- e.* Shade trees for protection from sun and heat.
- f.* Protected slope or trees as windbreaks in cold weather.
- g.* Firm ground for vehicles.
- h.* A good road net.
- i.* Concealment from air observation.

## **267. Undesirable Features for Camp Sites**

Features undesirable for camp sites are—

- a.* Dry beds of rivers, ravines, or depressed areas in country which is subject to rainstorms.
- b.* Clay; or loose, dusty soil.

c. Marshy ground; or areas near water which may be mosquito-infested or subject to mist or heavy dew.

d. Ground water level less than four feet below the surface of the ground.

e. Steep slopes.

f. Location within a mile of native villages in tropical or subtropical climates.

## 268. Ready Reference Data on Camp Sanitary Installations

### a. *Latrines.*

(1) Latrines should be located on the side of the camp opposite to prevailing winds at least 100 yards from any kitchen or water source, at a convenient distance from tents, and in such a location that the contents of the latrines will not drain toward the water supply.

(2) Latrine facilities should be adequate to take care of at least eight percent of the command at one time. Sixteen feet of straddle trench in 4-foot sections, or two deep pit latrines with standard 4-hole latrine boxes, are adequate for 100 men.

(3) If straddle trenches are used, separate urinals are not needed. If pit latrines are dug in impervious soil, one urine soakage pit should be provided for every 200 men or fraction thereof.

(4) Some type of hand-washing device should be installed near the latrine.

### b. *Kitchen Installations.*

(1) Solid kitchen wastes should be disposed

of by burial. If, due to the nature of the ground, burial is too difficult, the material may be burned in improvised field incinerators.

- (2) The kitchen should be located away from the latrines at the opposite side of the unit area.
- (3) A soakage pit with a barrel or baffle grease trap should be constructed for each kitchen. If the camp is to be occupied for an extended period, it may be desirable to provide a second soakage pit. If this is done, each soakage pit should be used on alternate days.
- (4) The proper number of mess kit washing lines (standard 3-can setup) should be provided on the basis of one quart of water, per can, per using individual.

*Note.* The standard 32-gallon G. I. can with immersion heater in place holds about 80 quarts of water.

*c. Wash Benches and Shower Baths.*

- (1) Wash benches and showers should be located between the unit area and the latrines.
- (2) Ten feet of wash bench should be allowed for every 100 men.
- (3) Approximately five shower heads should be allowed for every 100 men.

*d. Water Supply.*

- (1) Lyster bags are located between the kitchen and the company street.
- (2) Average daily requirement of water, per man, is :

|                     | <i>Gallons</i>  |
|---------------------|---|
| Semipermanent camps | 20 to 40  |
| Temporary camps     | 5 to 15   |
| Bivouac or marching | 2 to 5  |
| Minimum in combat   | 1 ( $\frac{1}{2}$ gallon absolute<br>minimum for a period<br>of 3 days only.) |

*e. Closing Camps.* All sanitary facilities should be closed before leaving a camp site. Latrines, garbage disposal sites and soakage pits should be back-filled and, unless security provisions preclude, properly marked and dated. It is well to remember that today's camp may be tomorrow's line of communication.

## APPENDIX

### CONVERSION TABLES

---

In the dilution and application of insecticides it is often necessary to determine the equivalent of various weights and measures. The following tables are intended for such use. These tables are so set up that equivalents may be found by reading across from either side.

#### *a. Weight.*

| <i>United States avoirdupois units</i> | <i>Metric units</i> |
|--|---------------------|
| 1 ounce (oz.)—16 drams (dr.)-----      | 28.35 grams (gm.)   |
| 1 pound (lb.)—16 ounces-----           | 453.59 grams        |
| 1 short ton—2,000 pounds-----          | 0.91 metric ton     |
| 1 long ton—2,240 pounds-----           | 1.02 metric tons    |

#### *b. Liquid Measure*

| <i>United States units</i>    | <i>Metric units</i>     |
|-------------------------------|-------------------------|
| 1 fluid ounce (fl. oz.)-----  | 29.57 milliliters (ml.) |
| 1 gill—4 fluid ounces-----    | 118.29 milliliters      |
| 1 pint (pt.)—4 gills-----     | 0.47 liter (l.)         |
| 1 quart (qt.)—2 pints-----    | 0.95 liter              |
| 1 gallon (gal.)—4 quarts----- | 3.79 liters             |

#### *c. Dry Measure.*

| <i>United States units</i>  | <i>Metric units</i> |
|-----------------------------|---------------------|
| 1 pint-----                 | 0.55 liters         |
| 1 quart—2 pints-----        | 1.1 liters          |
| 1 peck (pk.)—6 quarts-----  | 3.8 liters          |
| 1 bushel (bu.)—4 pecks----- | 35.24 liters        |

#### d. Measure of Length.

| United States units             | Metric units            |
|---------------------------------|-------------------------|
| 1 inch (in.)-----               | 25.4 millimeters (mm.)  |
| 1 foot (ft.)—12 inches-----     | 30.48 centimeters (cm.) |
| 1 yard (yd.)—3 feet-----        | 0.91 meter (m.)         |
| 1 rod (rd.)—5.5 yards-----      | 5.03 meters             |
| 1 mile—320 rods—5,280 feet----- | 1.61 kilometers (km.)   |

#### e. Area Measurement.

| United States units                        | Metric units                                |
|--|---|
| 1 square inch (sq. in.)-----               | 6.45 square centimeters (cm. <sup>2</sup> ) |
| 1 square foot (sq. ft.)—144 square inches. | 9.29 square decimeters (dm. <sup>2</sup> )  |
| 1 square yard (sq. yd.)—9 square feet.     | 0.84 square meter (m. <sup>2</sup> )        |
| 1 square rod (sq. rd.)—30.25 square yards. | 25.29 square meters                         |
| 1 acre—160 square rods—43,560 square feet. | 4046.87 square meters                       |

#### f. Cubic Measurement.

| United States units                        | Metric units                               |
|--|--|
| 1 cubic inch (cu. in.)-----                | 16.39 cubic centimeters (cc.)              |
| 1 cubic foot (cu. ft.)—1,728 cubic inches. | 29.32 cubic decimeters (dm. <sup>3</sup> ) |
| 1 cubic yard (cu. yd.)—27 cubic feet.      | 0.76 cubic meter (m. <sup>3</sup> )        |

g. Dilutions of spray materials are made according to the following formulas, depending upon the material.

$$\frac{A \times B}{C} = X$$

(1) For dilution of *emulsions* in water.

A = No. of gallons of spray desired.

B = Percent of dilution desired.

C = Percent of actual ingredient in concentrate.

X = No. of gallons of concentrate required.



- (2) *Example, emulsion concentrate.* 50 gallons of spray containing 2 percent DDT by weight is to be prepared from 25 percent DDT Emulsion Concentrate. The amount of concentrate required will be:

$$\frac{50 \times 2}{25} = 4 \text{ gallons}$$

Sufficient water is added to 4 gallons of 25 percent emulsion concentrate to make 50 gallons.

$$\frac{A \times 8.3 \times B}{C} = Y$$

- (3) For dilution of *wettable* powders in water

A = No. of gallons of spray desired.

B = Percent of dilution desired.

C = Percent of actual ingredient in concentrate.

Y = No. of pounds of concentrate required.

(8.345 = Weight in pounds of 1 gallon of water).

- (4) *Example, water wettable powder.* 50 gallons of spray containing 2 percent DDT is needed. The wettable powder to be used contains 75 percent DDT.

$$\frac{50 \times 8.345 \times 2}{75} = 11 \text{ pounds (approximately)}$$

Sufficient water is added to 11 pounds of water wettable powder to make 50 gallons.

*h. Aerial Spraying.* In calculating the amount of actual DDT (or other insecticide) used per acre by aircraft, it is necessary to know the swath width covered in feet, the speed of aircraft per minute, the

flow rate of insecticide per minute, and the percent and weight per gallon of insecticide.

*i. Example:* A C-46 type aircraft is travelling at 160 MPH and is covering a 100 yard swath (300 feet); rate of delivery is 30 gallons per minute; insecticide used is 20 percent DDT; weight of DDT is 7.65 pounds per gallon. How many pounds of actual DDT is being applied per acre?

(1) Formula:

$$\frac{S \times A}{N} = K$$

S = Swath width.  
A = Aircrafts speed in feet per minute.  
N = Number of square feet/acre.  
K = Number of acres sprayed/min.  
G = Gallons applied/min.  
W = Weight/gal.  
G × W × P × D    P = Percent of insecticide.  
                          D = Amount of DDT applied/min.  
 $\frac{D}{K} = X$                 X = Pounds actual DDT/acre.

(2) Application of Formula:

$$\frac{300 \text{ feet} \times 14,080 \text{ feet}}{43,560} = 97 \text{ acres sprayed per minute (approximately).}$$

$$30 \times 7.65 \times 0.20 = 45.9 \text{ pounds actual DDT delivered per minute.}$$

$$\frac{45.9 \text{ (actual pounds DDT/min)}}{97 \text{ (No. acres sprayed/min)}} = 0.47 \text{ pounds actual DDT/acre.}$$

See TB Med 200, Spraying of DDT from Aircraft, Feb 46 and Department of the Air Force AFM 90-4, Aerial Dispersal of Insecticides.

## INDEX

|                                  | Paragraph     | Page          |
|----------------------------------|---------------|---------------|
| Acclimatization.....             | 242, 248      | 255, 264      |
| Aersol bombs.....                | 151, 152      | 148, 155      |
| Allethrin.....                   | 151           | 148           |
| Amebic dysentery.....            | 58a           | 53            |
| Anti-coagulant rodenticides..... | 227a          | 237           |
| Ants.....                        | 211           | 217           |
| Arachnid-borne diseases.....     | 192, 200, 201 | 192, 198, 200 |
| Arctic:                          |               |               |
| Acclimatization.....             | 248           | 264           |
| Alcohol.....                     | 255           | 271           |
| Carbon monoxide poisoning..      | 252, 256      | 267, 272      |
| Clothing.....                    | 251           | 266           |
| Frostbite and freezing.....      | 252, 253      | 267           |
| Keys to survival.....            | 250           | 266           |
| Snow blindness.....              | 252, 254      | 267, 270      |
| Trenchfoot.....                  | 253d          | 269           |
| Army Medical Service.....        | 5             | 6             |
| Arthropod-borne diseases:        |               |               |
| Control measures.....            | 35            | 29            |
| Methods of transmission.....     | 34            | 28            |
| Baffle grease trap.....          | 87            | 88            |
| Bath water.....                  | 88            | 91            |
| Bedbugs.....                     | 210           | 214           |
| Black widow spiders.....         | 202           | 203           |
| Blackflies.....                  | 216           | 225           |
| Bubonic plague.....              | 205, 223      | 208, 234      |
| Calcium cyanide.....             | 232a          | 244           |
| Calcium hypochlorite.....        | 55, 56        | 47, 50        |
| Camp sites:                      |               |               |
| Procedures on arrival.....       | 263           | 279           |
| Sanitation:                      |               |               |
| Closing camps.....               | 268e          | 285           |
| Garbage.....                     | 265           | 281           |
| Kitchen installations....        | 268b          | 283           |
| Latrines.....                    | 265, 268a     | 281, 283      |
| Shower baths.....                | 268c          | 284           |

|                              | Paragraph                               | Page                                    |
|------------------------------|---|---|
| Camp sites—Continued         |   |   |
| Wash benches.....            | 268c                                    | 284                                     |
| Water Supply.....            | 265, 268d                               | 281, 284                                |
| Selection.....               | 264, 236, 267                           | 280, 282                                |
| Carbon disulphide.....       | 232c                                    | 245                                     |
| Carbon monoxide.....         | 66a, 232b, 256                          | 64, 244, 272                            |
| Care of feet.....            | 132                                     | 127                                     |
| Care of mouth and teeth..... | 131                                     | 125                                     |
| Chagas' disease.....         | 217                                     | 228                                     |
| Chigger-borne diseases.....  | 201a                                    | 200                                     |
| Chiggers.....                | 201                                     | 200                                     |
| Chlordane.....               | 196, 211b, 217                          | 196, 217, 228                           |
| Chlorination.....            | 55, 56                                  | 47, 50                                  |
| Chloroquine.....             | 143a                                    | 139                                     |
| Cholera.....                 | 180                                     | 184                                     |
| Closed soakage pit.....      | 85, 86                                  | 86, 87                                  |
| Communicable diseases:       |   |   |
| Control measures:            |   |   |
| Environmental sanitation     | 21                                      | 18                                      |
| Immunization.....            | 22b                                     | 19                                      |
| Isolation.....               | 20a                                     | 17                                      |
| Medical surveillance.....    | 20c                                     | 17                                      |
| Personal hygiene.....        | 20e, 22a                                | 18, 19                                  |
| Prophylaxis.....             | 22c, 27i, 39f                           | 19, 23, 32                              |
| Quarantine.....              | 20b                                     | 17                                      |
| Treatment.....               | 20d                                     | 18                                      |
| Definition.....              | 9                                       | 9                                       |
| Groups.....                  | 11                                      | 9                                       |
| Types.....                   | 10                                      | 9                                       |
| Comparator.....              | 55b                                     | 49                                      |
| DDT.....                     | 151, 170, 211,<br>212, 214, 216,<br>217 | 148, 173, 217,<br>219, 222, 225,<br>228 |
| Definitions:                 |   |   |
| Adaptation.....              | 240a                                    | 254                                     |
| Communicable diseases.....   | 9                                       | 9                                       |
| Conditioning.....            | 240b                                    | 254                                     |
| Contaminated water.....      | 41                                      | 34                                      |
| Hygiene.....                 | 2b, 124                                 | 4, 121                                  |

|                                | Paragraph                         | Page                              |
|--------------------------------|-----------------------------------|-----------------------------------|
| Definitions—Continued          |                                   |                                   |
| Immunity.....                  | 16                                | 14                                |
| Military Sanitation.....       | 2c                                | 4                                 |
| Polluted water.....            | 41                                | 34                                |
| Portable water.....            | 41                                | 34                                |
| Sanitation.....                | 2a                                | 4                                 |
| Susceptible individual.....    | 15                                | 14                                |
| Waste.....                     | 74                                | 72                                |
| Delousing:                     |                                   |                                   |
| Bathing.....                   | 176                               | 182                               |
| Bedding.....                   | 174                               | 180                               |
| Dust guns.....                 | 171b                              | 176                               |
| Dusting.....                   | 175                               | 181                               |
| Extra clothing.....            | 174                               | 180                               |
| Insecticides:                  |                                   |                                   |
| Application.....               | 171                               | 175                               |
| DDT.....                       | 151, 170, 211, 212, 214, 216, 217 | 148, 173, 217, 219, 222, 225, 228 |
| Lindane.....                   | 170                               | 173                               |
| Methyl bromide fumigation..    | 177                               | 183                               |
| Plant.....                     | 178                               | 183                               |
| Sifter can.....                | 172                               | 179                               |
| Spray.....                     | 173                               | 180                               |
| Unit delousing.....            | 169                               | 173                               |
| Dengue.....                    | 143b                              | 140                               |
| Dermatophytosis:               |                                   |                                   |
| Fungus infection of the feet.. | 237                               | 248                               |
| Ringworm.....                  | 237                               | 248                               |
| Dieldrin.....                  | 151, 211                          | 148, 217                          |
| Diseases:                      |                                   |                                   |
| Amebic dysentery.....          | 58a                               | 53                                |
| Arthropod-borne.....           | 33-35                             | 27                                |
| Bubonic plague.....            | 205, 223                          | 208, 234                          |
| Causes.....                    | 10                                | 9                                 |
| Chagas' disease.....           | 217                               | 228                               |
| Chigger-borne.....             | 201                               | 200                               |
| Cholera.....                   | 180                               | 184                               |
| Communicable.....              | 9-40                              | 9                                 |

|  | Paragraph              | Page          |
|--|------------------------|---------------|
| Diseases—Continued                       |                        |               |
| Control of source.....                   | 20                     | 17            |
| Dengue.....                              | 143 <i>b</i>           | 140           |
| Dermatophytosis.....                     | 11, 237                | 9, 248        |
| Dysentery.....                           | 180                    | 184           |
| Elephantiasis.....                       | 143 <i>e</i>           | 141           |
| Encephalitis.....                        | 143 <i>d</i>           | 140           |
| Endemic typhus.....                      | 205, 220, 223 <i>b</i> | 208, 231, 234 |
| Filariasis. ( <i>See</i> elephantiasis.) |                        |               |
| Flea-borne.....                          | 205                    | 208           |
| Fly-borne.....                           | 180, 181               | 184           |
| Insect-borne.....                        | 11, 32, 34             | 9, 27, 28     |
| Intestinal.....                          | 11, 28-31              | 9, 24         |
| Japanese river fever.....                | 201                    | 200           |
| Kala-azar.....                           | 214 <i>b</i>           | 222           |
| Leptospirosis.....                       | 223 <i>c</i>           | 234           |
| Louse-borne.....                         | 161                    | 168           |
| Malaria.....                             | 143 <i>r</i>           | 139           |
| Mite-borne.....                          | 200                    | 198           |
| Mosquito-borne.....                      | 143                    | 138           |
| Onchocerciasis.....                      | 216 <i>c</i>           | 227           |
| Oroya fever.....                         | 214 <i>b</i>           | 222           |
| Paratyphoid.....                         | 41                     | 34            |
| Plant dermatitis.....                    | 239                    | 252           |
| Q fever.....                             | 192                    | 192           |
| Rabies.....                              | 236                    | 247           |
| Rat-bite fever.....                      | 220                    | 231           |
| Relapsing fever.....                     | 161, 192               | 168, 192      |
| Respiratory diseases.....                | 11, 24-27              | 9, 19         |
| Rickettsialpox.....                      | 200                    | 198           |
| Rocky Mountain spotted fever             | 192 200, 223 <i>d</i>  | 192, 198, 234 |
| Salmonellosis.....                       | 223 <i>g</i>           | 235           |
| Sandfly fever.....                       | 214                    | 222           |
| Scabies.....                             | 11, 200, 238           | 9, 198, 251   |
| Schistosomiasis.....                     | 58 <i>b</i>            | 55            |
| Scrub typhus.....                        | 201, 220, 223 <i>e</i> | 200, 231, 234 |
| Tetanus.....                             | 11, 235                | 9, 246        |
| Tick-borne.....                          | 192                    | 192           |
| Transmission.....                        | 12                     | 10            |

|                                | Paragraph              | Page               |
|--------------------------------|------------------------|--------------------|
| Diseases—Continued             |                        |                    |
| Trench fever -----             | 161                    | 168                |
| Trenchfoot -----               | 253 <i>d</i>           | 269                |
| Trichinosis -----              | 223 <i>h</i>           | 235                |
| Tularemia -----                | 192, 220, 223 <i>f</i> | 192, 231, 235      |
| Typhoid -----                  | 180                    | 184                |
| Typhus -----                   | 161, 192               | 168, 192           |
| Venereal -----                 | 11, 36-40              | 9, 29              |
| Yellow fever -----             | 143 <i>c</i>           | 140                |
| Dusting -----                  | 154, 156, 171, 175     | 159, 162, 175, 181 |
| Dysentery -----                | 180                    | 184                |
| Elephantiasis -----            | 143 <i>e</i>           | 141                |
| Encephalitis:                  |                        |                    |
| Japanese B -----               | 143 <i>d</i>           | 140                |
| Endemic typhus -----           | 205, 220, 223 <i>b</i> | 208, 231, 234      |
| Engineer Corps -----           | 6                      | 7                  |
| Environmental sanitation ----- | 21                     | 18                 |
| Feet -----                     | 132                    | 127                |
| Filariasis -----               | 11, 143 <i>e</i>       | 9, 141             |
| Flea-borne diseases -----      | 205                    | 208                |
| Fleas:                         |                        |                    |
| Control measures -----         | 207, 208               | 211, 213           |
| Life cycle -----               | 206                    | 210                |
| Flies:                         |                        |                    |
| Characteristics -----          | 182, 183               | 184, 186           |
| Control measures:              |                        |                    |
| Breeding places -----          | 185                    | 187                |
| Field waste disposal -----     | 186                    | 188                |
| Fly baits -----                | 188                    | 188                |
| Flytraps -----                 | 190                    | 190                |
| Residual spray -----           | 188                    | 188                |
| Screening -----                | 187                    | 188                |
| Space spray -----              | 188                    | 188                |
| Swatting -----                 | 189                    | 190                |
| Fly-borne diseases -----       | 180, 181               | 184                |

|  | Paragraph    | Page     |
|--|--------------|----------|
| Food:                                  |              |          |
| Handlers.....                          | 113          | 110      |
| Handling and storage.....              | 106-111      | 104      |
| Inspection:                            |              |          |
| Canned foods.....                      | 105          | 103      |
| Dairy products.....                    | 104          | 103      |
| Eggs.....                              | 102          | 101      |
| Meat.....                              | 100          | 100      |
| Poultry.....                           | 101          | 101      |
| Seafood.....                           | 103          | 102      |
| Preparation and serving:               |              |          |
| Chopped meats.....                     | 117          | 113      |
| Fruits and vegetables.....             | 114          | 111      |
| Hash.....                              | 117          | 113      |
| Leftovers.....                         | 118          | 115      |
| Milk.....                              | 115, 116     | 112, 113 |
| Salads.....                            | 117          | 113      |
| Temperature guides.....                | 118          | 115      |
| Frostbite.....                         | 253          | 267      |
| Fungus infection.....                  | 132 <i>d</i> | 128      |
| Garbage.....                           | 89-93        | 93       |
| Gnats.....                             | 213          | 220      |
| Grease traps.....                      | 87           | 88       |
| Heat cramps.....                       | 245 <i>c</i> | 262      |
| Heat exhaustion.....                   | 245 <i>a</i> | 261      |
| Heatstroke.....                        | 245 <i>b</i> | 261      |
| Handwashing devices.....               | 70, 71       | 67, 68   |
| Hygiene:                               |              |          |
| March:                                 |              |          |
| Conduct.....                           | 259          | 275      |
| Halts.....                             | 260          | 275      |
| Health on marches.....                 | 261          | 277      |
| Inspections before<br>marches.....     | 258          | 274      |
| Personal:                              |              |          |
| Avoidance of source of<br>disease..... | 138          | 132      |
| Care of feet.....                      | 132          | 127      |



|  | Paragraph      | Page       |
|--|----------------|------------|
| <b>Hygiene: Personal—Continued</b>           |                |            |
| Care of mouth and teeth.....                 | 131            | 125        |
| Cleanliness.....                             | 130            | 124        |
| Definition.....                              | 124            | 121        |
| Exercise.....                                | 134            | 131        |
| Food and drink.....                          | 133            | 130        |
| Importance.....                              | 125, 128       | 121, 123   |
| Medical treatment.....                       | 127            | 122        |
| Mental health.....                           | 140            | 133        |
| Principles.....                              | 129            | 123        |
| Protection against disease-born insects..... | 137            | 132        |
| Protection against elements.....             | 136            | 132        |
| Responsibility.....                          | 126            | 121        |
| Rest and recreation.....                     | 135            | 131        |
| Rules for avoiding illness in field.....     | 141            | 135        |
| Special protective measures.....             | 139            | 133        |
| Sex.....                                     | 39e            | 32         |
| <b>Immune.....</b>                           | <b>15</b>      | <b>14</b>  |
| <b>Immunity.....</b>                         | <b>16</b>      | <b>14</b>  |
| <b>Immunization:</b>                         |                |            |
| Army program.....                            | 17             | 15         |
| Cholera.....                                 | 17             | 15         |
| Diphtheria.....                              | 17             | 15         |
| Paratyphoid.....                             | 17             | 15         |
| Records.....                                 | 18             | 16         |
| Smallpox.....                                | 17             | 15         |
| Tetanus.....                                 | 235            | 246        |
| Typhoid.....                                 | 17             | 15         |
| Typhus.....                                  | 17             | 15         |
| Yellow fever.....                            | 17             | 15         |
| <b>Improvised sanitary devices:</b>          |                |            |
| Handwashing devices.....                     | 70, 71         | 67, 68     |
| Shower facilities.....                       | 72, 73         | 69, 70     |
| <b>Infection.....</b>                        | <b>13</b>      | <b>11</b>  |
| <b>Insect resistance.....</b>                | <b>157-159</b> | <b>165</b> |

|                               | Paragraph     | Page          |
|-------------------------------|---------------|---------------|
| Insect-borne diseases .....   | 11, 32, 34    | 9, 27, 28     |
| Insecticides:                 |               |               |
| Allethrin .....               | 151, 211      | 148, 217      |
| Chlordane .....               | 196, 211      | 196, 217      |
| DDT .....                     | 151, 170, 196 | 148, 173, 196 |
| Dieldrin .....                | 151, 196      | 148, 196      |
| Lindane .....                 | 151, 170, 211 | 148, 173, 217 |
| Malathion .....               | 211           | 217           |
| Precautions .....             | 159           | 166           |
| Pyrethrum .....               | 151           | 148           |
| Intestinal diseases:          |               |               |
| Cause .....                   | 28            | 24            |
| Control measures .....        | 31            | 25            |
| Groups .....                  | 29            | 24            |
| Transmission .....            | 30            | 24            |
| Isolation .....               | 20a           | 17            |
| Japanese river fever .....    | 201           | 200           |
| Kala-azar .....               | 214           | 222           |
| Kissing bugs .....            | 217           | 228           |
| Kitchen sanitation:           |               |               |
| Cooking utensils .....        | 121, 122      | 117           |
| Food:                         |               |               |
| Handlers .....                | 113           | 110           |
| Handling and storage .....    | 106-111       | 104           |
| Inspection .....              | 99-105        | 100           |
| Preparation and serving ..... | 112-118       | 109           |
| Refrigeration .....           | 109           | 106           |
| Storage rules .....           | 111           | 107           |
| Importance .....              | 97            | 99            |
| Mess gear .....               | 123           | 118           |
| Mess halls .....              | 120           | 116           |
| Responsibilities .....        | 98            | 99            |
| Wastes .....                  | 86-87         | 87            |
| Larval control .....          | 149           | 146           |
| Larvicides .....              | 149           | 146           |
| Latrines:                     |               |               |
| Bored-hole .....              | 82            | 82            |

|                                 | Paragraph   | Page     |
|---------------------------------|-------------|----------|
| Latrines—Continued              |             |          |
| Construction.....               | 78          | 75       |
| Deep pit.....                   | 80          | 78       |
| Location.....                   | 268a        | 283      |
| Mound.....                      | 81          | 80       |
| Operation.....                  | 85          | 86       |
| Pail.....                       | 83          | 82       |
| Straddle trench.....            | 79          | 77       |
| Urine disposal facilities.....  | 84          | 83       |
| Leptospirosis.....              | 223         | 234      |
| Lice:                           |             |          |
| Body.....                       | 162, 164    | 170, 171 |
| Characteristics.....            | 167         | 172      |
| Crab.....                       | 162, 166    | 170, 171 |
| Delousing.....                  | 168-178     | 172      |
| Head.....                       | 162, 165    | 170, 171 |
| Lindane.....                    | 151         | 148      |
| Louse-borne diseases.....       | 161         | 168      |
| Lyster bags.....                | 46c, 56     | 39, 50   |
| Malaria:                        |             |          |
| Cause.....                      | 143a        | 139      |
| Discipline.....                 | 143a, 152   | 139, 155 |
| Suppressive treatment.....      | 143a, 152   | 139, 155 |
| Malathion.....                  | 211b        | 217      |
| Mental health.....              | 140         | 133      |
| Menthyl bromide fumigation..... | 177         | 183      |
| Mess gear washing devices.....  | 67-49, 123  | 65, 118  |
| Mess sanitation.....            | 27h, 97-123 | 23, 99   |
| Military sanitation:            |             |          |
| Definition.....                 | 2c          | 4        |
| Importance.....                 | 3           | 5        |
| Responsibility.....             | 4-8         | 5        |
| Mite-borne diseases.....        | 200         | 198      |
| Mites.....                      | 200         | 198      |
| Mosquito-borne diseases.....    | 143         | 138      |
| Mosquito control:               |             |          |
| Adult control.....              | 150         | 148      |

|                                | Paragraph            | Page           |
|--------------------------------|----------------------|----------------|
| Mosquito control—Continued     |                      |                |
| Area protective measures:      |                      |                |
| Equipment.....                 | 156a                 | 162            |
| Residual spray.....            | 156b                 | 164            |
| Space spraying.....            | 156c                 | 165            |
| Camp sites.....                | 148                  | 146            |
| Individual protective measures | 152                  | 155            |
| Insecticides.....              | 151                  | 148            |
| Larval control.....            | 149                  | 146            |
| Mosquito proofing.....         | 155                  | 161            |
| Nets.....                      | 152c                 | 156            |
| Repellents.....                | 152d                 | 157            |
| Responsibility.....            | 147                  | 144            |
| Unit control equipment.....    | 154                  | 159            |
| Unit protective measures.....  | 153                  | 158            |
| <br>                           |                      |                |
| Onchocerciasis.....            | 216                  | 225            |
| Orthotolidine.....             | 55                   | 47             |
| Oroya fever.....               | 214                  | 222            |
| <br>                           |                      |                |
| Pail filter grease trap.....   | 86                   | 87             |
| Paratyphoid.....               | 41                   | 34             |
| Personal hygiene.....          | 20e, 22a, 27g,<br>77 | 18, 19, 23, 73 |
| Plant dermatitis.....          | 239                  | 252            |
| Poisoning:                     |                      |                |
| Carbon monoxide.....           | 66a, 256             | 64, 272        |
| Ivy.....                       | 239b                 | 253            |
| Lead.....                      | 66b                  | 65             |
| Oak.....                       | 239b                 | 253            |
| Rodenticides.....              | 227                  | 237            |
| Preventive Medicine units..... | 147                  | 144            |
| Prickly heat.....              | 245e                 | 262            |
| Prophylaxis.....               | 22c, 27i, 39f        | 19, 23, 32     |
| Punkies.....                   | 215                  | 224            |
| <br>                           |                      |                |
| Q fever.....                   | 192                  | 192            |
| Quarantine.....                | 20b, 27b             | 17, 21         |
| Quartermaster.....             | 7                    | 8              |

|  | Paragraph          | Page               |
|--|--------------------|--------------------|
| Rabies.....                              | 236                | 247                |
| Rat-bite fever.....                      | 220                | 231                |
| Relapsing fever.....                     | 161, 192           | 168, 192           |
| Repellents.....                          | 152, 212, 214, 216 | 155, 219, 222, 225 |
| Respiratory diseases.....                | 11, 24-27          | 9, 19              |
| Responsibility:                          |                    |                    |
| Army Medical Service.....                | 5                  | 6                  |
| Commander.....                           | 4a                 | 5                  |
| Corps of Engineers.....                  | 6                  | 7                  |
| Individual.....                          | 8                  | 8                  |
| Quartermaster.....                       | 7                  | 8                  |
| Surgeon.....                             | 4b                 | 6                  |
| Rickettsia.....                          | 167c               | 172                |
| Rickettsialpox.....                      | 200                | 198                |
| Roaches.....                             | 211                | 217                |
| Rocky Mountain spotted fever.....        | 192, 220, 223      | 192, 231, 234      |
| Rodents:                                 |                    |                    |
| Control:                                 |                    |                    |
| Baits.....                               | 228                | 238                |
| Classification.....                      | 221                | 231                |
| Destructive measures.....                | 225b               | 236                |
| Diseases associated with<br>rodents..... | 223                | 234                |
| Economic importance.....                 | 219                | 230                |
| Fumigation.....                          | 230-232            | 243                |
| Handling dead rats.....                  | 233                | 245                |
| Poisoning.....                           | 226, 227           | 236, 237           |
| Suppressive measures.....                | 225a               | 236                |
| Trapping.....                            | 229                | 241                |
| Disease transmission.....                | 220                | 231                |
| Life cycle.....                          | 222                | 232                |
| Rubbish.....                             | 94-96              | 97                 |
| Salmonellosis.....                       | 223                | 234                |
| Salt requirements.....                   | 244                | 259                |
| Sandflies.....                           | 214                | 222                |
| Sandfly fever.....                       | 214                | 222                |
| Scabies.....                             | 11, 200, 238       | 9, 198, 251        |

|                              | Paragraph          | Page               |
|------------------------------|--------------------|--------------------|
| Schistosomiasis.....         | 58b                | 55                 |
| Scorpion stings.....         | 203, 204           | 205, 207           |
| Scrub typhus.....            | 201, 220, 223      | 200, 231, 234      |
| Sex hygiene.....             | 39e                | 32                 |
| Shower facilities.....       | 72, 73             | 69, 70             |
| Snow blindness.....          | 254                | 270                |
| Spraying.....                | 151, 154, 156, 188 | 148, 159, 162, 188 |
| Stableflies.....             | 212                | 219                |
| Sunburn.....                 | 245d               | 262                |
| Suppressive treatment.....   | 143, 152           | 138, 155           |
| Susceptible individual.....  | 15                 | 14                 |
| Tapeworm.....                | 205                | 208                |
| Tetanus.....                 | 11, 235            | 9, 246             |
| Tick-borne diseases.....     | 192                | 192                |
| Ticks:                       |                    |                    |
| Characteristics.....         | 192, 193           | 192, 194           |
| Control:                     |                    |                    |
| Breeding areas.....          | 195                | 196                |
| Insecticides.....            | 196                | 196                |
| Preventive measures.....     | 197                | 197                |
| Removal.....                 | 199                | 197                |
| Repellants.....              | 198                | 197                |
| Transmission of disease..... | 12, 14             | 10, 12             |
| Direct.....                  | 14a                | 12                 |
| Indirect.....                | 14b                | 12                 |
| Trenchfoot.....              | 253d               | 269                |
| Trichinosis.....             | 223h               | 235                |
| Tropics:                     |                    |                    |
| Acclimatization.....         | 242                | 255                |
| Fungus infections.....       | 246                | 263                |
| Heat cramps.....             | 245c               | 262                |
| Heat exhaustion.....         | 245a               | 261                |
| Heatstroke.....              | 245b               | 261                |
| Prickly heat.....            | 245e               | 262                |
| Salt requirements.....       | 244                | 259                |
| Sunburn.....                 | 245d               | 262                |
| Water requirements.....      | 243                | 257                |

|   | Paragraph      | Page          |
|---|----------------|---------------|
| Tularemia.....                          | 192, 220, 223f | 192, 231, 235 |
| Typhoid.....                            | 189            | 184           |
| Typhus.....                             | 161, 192       | 168, 192      |
| Urine disposal facilities.....          | 84             | 83            |
| Vector control details.....             | 147, 153       | 144, 158      |
| Venereal diseases.....                  | 11, 36-40      | 9, 29         |
| Waste disposal:                         |                |               |
| Definition.....                         | 74             | 72            |
| Garbage.....                            | 89-93          | 93            |
| Grease traps.....                       | 87             | 88            |
| Human wastes.....                       | 77-85          | 73            |
| Kitchen wastes.....                     | 86, 87         | 87, 88        |
| Latrines.....                           | 78-85, 268a    | 75, 283       |
| Liquid wastes.....                      | 86-88          | 87            |
| Medical importance.....                 | 75             | 72            |
| Responsibilities.....                   | 76             | 73            |
| Rubbish.....                            | 94-96          | 97            |
| Water:                                  |                |               |
| Contaminated.....                       | 41             | 34            |
| Diseases transmitted by water           | 41             | 34            |
| Heaters:                                |                |               |
| Fire trench.....                        | 62             | 57            |
| Flash - type oil - water<br>burner..... | 63             | 58            |
| Modified M-1937 heater.....             | 65             | 63            |
| Operation hazards.....                  | 66             | 64            |
| Vapor-type burner.....                  | 64             | 60            |
| Polluted.....                           | 41             | 34            |
| Potable.....                            | 41             | 34            |
| Purification, field:                    |                |               |
| Calcium hypochlorite.....               | 55, 56         | 47, 50        |
| Chlorination.....                       | 53c, 55, 56    | 45, 47, 50    |
| Diatomite fillers.....                  | 54a            | 46            |
| Distillation equipment.....             | 54f            | 47            |
| Emergency supply.....                   | 56             | 50            |
| Filtration.....                         | 53b, 58a       | 45, 53        |
| Hypochlorinators.....                   | 54c            | 46            |

|   | Paragraph | Page   |
|---|-----------|--------|
| Purification, field—Continued             |           |        |
| Individual supply.....                    | 57, 58a   | 53     |
| Knapsack - pack water<br>filter unit..... | 54b       | 46     |
| Lyster bags.....                          | 56        | 50     |
| Pumps.....                                | 54e       | 47     |
| Residuals.....                            | 55        | 47     |
| Sedimentation.....                        | 53a, 58a  | 45, 53 |
| Special treatment<br>methods.....         | 58        | 53     |
| Storage tanks.....                        | 54d       | 47     |
| Sources.....                              | 44-46     | 36     |
| Supply:                                   |           |        |
| Construction.....                         | 46b       | 38     |
| Discipline.....                           | 47        | 41     |
| Equipment, purification..                 | 46b, c    | 38, 39 |
| Individual.....                           | 57        | 53     |
| Location.....                             | 46a       | 37     |
| Protective precautions...                 | 46        | 37     |
| Quantity.....                             | 43        | 35     |
| Reconnaissance.....                       | 48-52     | 42     |
| Requirements in the<br>tropics.....       | 243       | 257    |
| Responsibility.....                       | 42        | 35     |
| Sanitary control.....                     | 46d       | 41     |
| Storage.....                              | 46c       | 39     |
| Yellow fever.....                         | 143c      | 140    |
| Zinc phosphide.....                       | 227b      | 238    |

[AG 721 (23 Aug 56)]

BY ORDER OF THE SECRETARIES OF THE ARMY AND THE  
AIR FORCE:

MAXWELL D. TAYLOR,  
*General, United States Army,*  
*Chief of Staff.*

OFFICIAL:

HERBERT M. JONES,  
*Major General, United States Army,*  
*The Adjutant General.*



N. F. TWINING,

OFFICIAL: Chief of Staff, United States Air Force.  
 J. L. TARR,  
 Colonel, United States Air Force,  
 Air Adjutant General.

Distribution:

Army:

Active Army:

|                  |                     |
|------------------|---------------------|
| Tec Svc, DA      | PMST Sr Div Unit    |
| Hq CONARC        | PMST Jr Div Unit    |
| Army AA Comd     | Gen Depot           |
| OS Maj Comd      | Sup Sec, Gen Depot  |
| OS Base Comd     | Depot               |
| Log Comd         | AH                  |
| MDW              | RTC                 |
| Armies           | MTC                 |
| Corps            | US Army Tng Cen     |
| Div              | Army Terminal       |
| Brig             | Trans Terminal Comd |
| Regt             | POE (OS)            |
| Bn               | OS Sup Agencies     |
| Co               | Disp                |
| Instl            | Mil Dist            |
| USMA             | MAAG                |
| Gen & Br Svc Sch | Mil Man             |

NG: State AG; units—same as Active Army.

USAR: Same as Active Army.

For explanation of abbreviations used, see SR 320-50-1.

Air Force:

Zone of Interior and Overseas:

|                                   |     |
|-----------------------------------|-----|
| Headquarters USAF.....            | 350 |
| Major air commands.....           | 10  |
| Except: State Adjutants, ANG..... | 1   |
| Subordinate air commands.....     | 5   |
| Bases.....                        | 3   |
| Wings.....                        | 3   |
| Groups.....                       | 2   |
| Squadrons.....                    | 2   |